



INSTRUCTION MANUAL

MF/HF MARINE TRANSCEIVER  
**GM800**



Thank you for choosing this Icom product. This product is designed and built with Icom's state of the art technology and craftsmanship. With proper care, this product should provide you with years of trouble-free operation.

The GM800 has Class A DSC functions for Distress alert transmission and reception, as well as general DSC calls (Individual call, Group call, Geographic Area call, Position Request call, Polling Request call, and Test call).

## IMPORTANT

**READ ALL INSTRUCTIONS** carefully and completely before using the transceiver.

**SAVE THIS INSTRUCTION MANUAL** — This instruction manual contains important operating instructions for the GM800.

This instruction manual includes some functions that are usable only when your dealer preset them. Ask your dealer for details.

**NOTE:** This transceiver receives the frequency range 30 kHz ~ 500 kHz in the J3E mode, but it has not been tested and Icom does not warrant the operation in this frequency range. Thus this transceiver does not conform to the permission of the frequency range 415 kHz ~ 526.5 kHz which is permitted by the ITU Radio Regulations [3].

**To stabilize the output frequency:**  
 $\pm 10$  Hz frequency stability requires a warming up time period.  
 The warming up time period is within 30 minutes after turning ON the transceiver's main power, and it differs depending on the output temperature.

## EXPLICIT DEFINITIONS

WORD	DEFINITION
<b>⚠ DANGER!</b>	Personal death, serious injury or an explosion may occur.
<b>⚠ WARNING!</b>	Personal injury, fire hazard or electric shock may occur.
<b>CAUTION</b>	Equipment damage may occur.
<b>NOTE</b>	If disregarded, inconvenience only. No risk of personal injury, fire or electric shock.

## IN CASE OF EMERGENCY

If your vessel requires assistance, contact other vessels and the Coast Guard by sending a Distress call using Digital Selective Calling (DSC) on an emergency frequency.

### When immediate help is needed:

1. While lifting the key cover, hold down [DISTRESS] for 3 seconds until you hear 3 short countdown beeps and 1 long beep sound.
2. Wait for an Acknowledgment from another station.
3. After the Acknowledgment is received, hold down [PTT] on the microphone and send the following information.
  - 1 "MAYDAY, MAYDAY, MAYDAY."
  - 2 "THIS IS . . . . . (name of vessel)."
  - 3 "LOCATED AT . . . . (vessel's position)."
  - 4 Give the reason for the Distress call.
  - 5 Explain what assistance you need.
  - 6 Give additional information about your vessel:
    - Type
    - Length
    - Color
    - The number of people on board

## INSTALLATION NOTE

### Installation:

The installation of this equipment should be made in such a manner as to respect the EC recommended electromagnetic field exposure limits. (1999/519/EC)

The maximum RF power available from this device, including tuner is 125 watts. The antenna should be installed as high as possible for maximum efficiency and the installation height should be at least 3 meters above any accessible position. In the case where an antenna cannot be installed at a reasonable height, then the transmitter should neither be continuously operated for long periods if any person is within a distance of 3 meters of the antenna, nor operated at all if any person is touching the antenna.

It is recommended that antenna of a maximum gain of 0 dBd is used. If higher gain antenna are required then please contact your Icom distributor for revised installation recommendations.

### Operation:

The exposure to RF electromagnetic field is only applicable when this device is transmitting. This exposure is naturally reduced due to the nature of alternating periods of receiving and transmitting. Keep your transmissions to the minimum necessary.

---

## PRECAUTIONS

---

**⚠ DANGER HIGH RF VOLTAGE! NEVER** touch an antenna or antenna connector while transmitting. This could cause an electrical shock or burn.

**⚠ WARNING! NEVER** operate the transceiver during a lightning storm. It may result in an electric shock, cause a fire or damage the transceiver. Always disconnect the power source and antenna before a storm.

**⚠ WARNING! NEVER** connect the transceiver to an AC outlet. This may pose a fire hazard and/or result in an electric shock.

**⚠ WARNING! NEVER** mount the transceiver's main unit overhead. The weight of the main unit is approximately 8.7 kg, and it could easily fall due to wave shocks or vibration. The unit must be mounted on a flat hard surface only.

**⚠ WARNING! NEVER** connect a power source of more than 31.2 V DC. This connection could cause a fire or damage the transceiver.

**⚠ WARNING! NEVER** place the transceiver where normal operation of the vessel may be hindered or where it could cause bodily injury.

**⚠ WARNING! NEVER** let metal, wire, or other objects contact the transceiver inside or make incorrect contact with connectors on the front panel. This could cause an electric shock or damage the transceiver.

**CAUTION DO NOT** reverse the DC power cable polarity. This could damage the transceiver.

**CAUTION: DO NOT** use harsh solvents such as Benzine or alcohol when cleaning the equipment. This could damage the equipment surfaces. If the surface becomes dusty or dirty, wipe it clean with a soft, dry cloth.

**CAUTION: DO NOT** use or leave the transceiver in areas with temperatures below  $-15^{\circ}\text{C}$  or above  $+55^{\circ}\text{C}$ , or in areas exposed to direct sunlight, such as the dashboard.

**CAUTION: DO NOT** use or leave the transceiver in excessively dusty environments.

**CAUTION: DO NOT** use a non-specified microphone. Other microphones may have different pin assignments and may damage the transceiver.

**NEVER** place the transceiver in an insecure place to avoid inadvertent use by unauthorized persons.

**BE CAREFUL!** The transceiver's main unit may become hot after continuously transmitting for long periods of time.

**BE CAREFUL!** The remote controller meets IPX7\* requirements for waterproof protection. However, once the remote controller has been dropped and cracked, or the waterproof seal is cracked or damaged, waterproof protection cannot be guaranteed.

\* Only when the handset or optional HM-214, remote controller cable, and connector cap are attached.

**NOTE:** Install the transceiver and microphone at a distance of more than 1 meter from the vessel's magnetic navigation compass.

The LCD display may have cosmetic imperfections that appear as small dark or light spots. This is not a malfunction or defect, but a normal characteristic of LCD displays.

---

## RECOMMENDATION

---

**CLEAN THE REMOTE CONTROLLER'S FRONT PANEL THOROUGHLY IN A BOWL OF FRESHWATER** after exposure to saltwater, and dry it before operating. Otherwise, the remote controller keys and switches may become unusable, due to salt crystallization.

① The connectors on the rear panel do not meet IPX7.

**NOTE:** If the remote controller's waterproof protection appears defective, carefully clean it with a soft, damp (freshwater) cloth, then dry it before operating. The remote controller may lose its waterproof protection if the case or connector cover is cracked or broken, or the remote controller has been dropped. Contact your dealer for advice.

---

## DISPOSAL

---



The crossed-out wheeled-bin symbol on your product, literature, or packaging reminds you that in the European Union, all electrical and electronic products, batteries, and accumulators (rechargeable batteries) must be taken to designated collection locations at the end of their working life. Do not dispose of these products as unsorted municipal waste. Dispose of them according to the laws in your area.

---

# TABLE OF CONTENTS

---



IMPORTANT.....	i	<b>6. DSC OPERATION.....</b>	<b>22</b>
EXPLICIT DEFINITIONS.....	i	■ About DSC.....	22
IN CASE OF EMERGENCY.....	i	■ DSC address ID.....	22
INSTALLATION NOTE.....	i	◇ Entering an Individual ID and Group ID.....	22
PRECAUTIONS.....	ii	◇ Deleting an entered ID.....	24
RECOMMENDATION.....	ii	■ Entering position data and time.....	24
DISPOSAL.....	ii	■ DSC Task mode.....	25
KEY ICON DESCRIPTION.....	iv	◇ Holding a DSC task.....	25
<b>1. OPERATING RULES.....</b>	<b>1</b>	◇ Activating the held DSC task.....	25
<b>2. PANEL DESCRIPTION.....</b>	<b>2</b>	◇ Task List.....	25
■ Main unit.....	2	■ Sending DSC calls (Distress).....	26
■ Remote Controller front panel.....	3	◇ Simple call.....	26
■ Handset (HS-98).....	4	◇ Regular call.....	27
◇ About the Speaker Switch.....	4	◇ Resending a Distress call.....	28
■ Optional HM-214H.....	4	◇ Sending a Distress Cancel call.....	29
■ Software Key function.....	4	◇ Sending a Distress Acknowledgment.....	31
◇ Selecting the Software Key function.....	4	◇ Sending a Distress Relay call.....	32
◇ Functions.....	5	◇ Sending a Distress Relay Acknowledgment.....	36
■ Function display (Main screen).....	6	■ Sending DSC calls (Other).....	37
◇ Status area.....	6	◇ Sending an Individual call.....	37
◇ Task area.....	6	◇ Sending an Individual Acknowledgment.....	38
◇ Channel and Frequency area.....	6	◇ Sending a Group call.....	39
◇ Information area.....	7	◇ Sending a Geographic Area call.....	41
◇ Software Key area.....	7	◇ Sending a Position Request call.....	43
◇ Position and Time area.....	7	◇ Sending a Position Request Acknowledgment.....	44
<b>3. PREPARATION.....</b>	<b>8</b>	◇ Sending a Polling Request Acknowledgment.....	45
■ Entering the MMSI code.....	8	◇ Sending a Test call.....	46
<b>4. BASIC OPERATION.....</b>	<b>9</b>	◇ Sending a Test call Acknowledgment.....	47
■ Selecting a Channel or Group.....	9	◇ Sending a Medical Transports call or Ships and Aircraft call.....	48
◇ Using the channel and group selector.....	9	■ Receiving DSC calls.....	51
◇ Using the keypad.....	9	◇ Receiving a Distress Call.....	51
■ Receiving and transmitting.....	10	◇ Receiving a Distress Acknowledgment.....	52
◇ Receiving.....	10	◇ Receiving a Distress Cancel call.....	53
◇ Transmitting.....	10	◇ Receiving a Distress Relay call.....	53
■ DSC scan.....	10	◇ Receiving a Distress Relay Acknowledgment.....	54
<b>5. OTHER FUNCTIONS AND OPERATIONS.....</b>	<b>11</b>	■ Receiving DSC calls (other).....	55
■ Backlight function.....	11	◇ Receiving an Individual call.....	55
■ Instant Replay function.....	11	◇ Receiving an Individual Acknowledgment.....	56
◇ Playback the recorded voice.....	11	◇ Receiving a Group call.....	57
■ Scan.....	12	◇ Receiving a Geographic Area call.....	58
◇ Channel and Channel Resume scan.....	12	◇ Receiving a Position Request call.....	58
◇ Program scan.....	12	◇ Receiving a Position Request Acknowledgment.....	59
■ Other functions.....	13	◇ Receiving a Polling Request call.....	59
■ Setting a temporary operating frequency.....	14	◇ Receiving a Test call.....	60
■ Setting a User channel or an ITU Simplex channel.....	15	◇ Receiving a Test Acknowledgment.....	60
■ Assigning a function.....	16	◇ Receiving a Medical Transports call.....	61
◇ Assigning a Software Key function to a Software Key.....	16	◇ Receiving a Ships and Aircraft call.....	61
◇ Assigning a Software Key function to [VOL].....	17	■ Received Call log.....	62
◇ Assigning a Software Key function to [P] on the HM-214H MICROPHONE.....	17	◇ Distress message.....	62
■ Bridge Alert Management (BAM).....	18	◇ Other messages.....	62
◇ Turning ON the BAM function.....	18	■ Transmitted Call log.....	62
◇ Category.....	18	■ DSC Settings.....	63
◇ Priority.....	18	◇ DSC Frequency.....	63
◇ Responsibility transfer.....	19	◇ Scanning Receiver.....	64
◇ Alert.....	19	◇ Auto ACK.....	65
◇ Icon and Status.....	20	◇ Medical Transports.....	65
◇ BAM List.....	20	◇ Ships and Aircraft.....	65
◇ Software Key functions.....	21	◇ CH Auto Switch.....	66
		◇ DSC Data Output.....	66
		◇ Alarm Status.....	66

◇ Auto Print .....	67
◇ Self Check Test .....	67
<b>7. MENU SCREEN .....</b>	<b>68</b>
■ About the Menu screen .....	68
■ Selecting the item .....	68
■ Menu Construction .....	69
■ GPS Information .....	71
■ Configuration .....	71
■ Radio Settings .....	73
■ Radio information .....	73
<b>8. CONNECTIONS AND INSTALLATION .....</b>	<b>74</b>
■ Connections .....	75
◇ Basic connections .....	75
◇ Advanced connections .....	76
◇ Connecting the microphone .....	76
◇ Connecting the remote control cable .....	76
■ Ground connection .....	77
■ Software maintenance .....	77
■ Power source .....	78
■ Antenna .....	78
■ Mounting .....	79
◇ Mounting location .....	79
◇ Mounting the remote controller .....	79
◇ Mounting the main unit .....	80
■ MB-108 installation .....	81
■ Replacing fuses .....	82
■ Connector information .....	83
■ Transceiver dimensions .....	84
<b>9. SPECIFICATIONS AND OPTIONS .....</b>	<b>85</b>
■ Specifications .....	85
◇ General .....	85
◇ Transmitter .....	85
◇ Receiver .....	85
■ Options .....	86
◇ Antenna Tuner .....	86
◇ Microphone .....	86
◇ Others .....	86
<b>10. TROUBLESHOOTING .....</b>	<b>87</b>
<b>11. DIGITAL INTERFACE (IEC 61162-1) .....</b>	<b>88</b>
■ I/O Sentences .....	88
◇ Version number .....	88
◇ GPS Input sentences (IEC 61162-1) .....	88
◇ GPS Input sentence description .....	88
◇ Remote Input and Output sentences (IEC 61162-1) ..	89
◇ Remote sentence description .....	89
■ BAM Sentences .....	90
◇ Version number .....	90
◇ Input sentences (IEC 61162-1) .....	90
◇ Input sentence description .....	90
◇ Output sentences (IEC 61162-1) .....	90
◇ Output interval .....	90
◇ Output sentence description .....	90
■ Schematic diagram .....	91
■ Hardware version .....	92
■ Software version .....	92
<b>12. BAM ALERTS .....</b>	<b>93</b>
<b>INDEX .....</b>	<b>97</b>

## KEY ICON DESCRIPTION

The keys are described in this manual as follows:  
The keys that have words or letters on them are described with the characters “[ ].”





Example: [ENT], [CLR]

The Software Keys are described with the characters “[ ]” and , such as [Finish]  or [Home] . The functions of the keys are shown at the bottom of the display. Push the key below the desired function.

You can use the following keys on the Menu screen.

FUNCTION	ACTION
Select	Push [▲] or [▼].
Enter	Push [ENT] or [CH/GRP].
Go to the next tree level	Push [ENT], [CH/GRP], or [▶].
Go back to the previous tree level	Push [CLR], [◀].
Cancel	Push [CLR].
Exit	Push [MENU] or [Home]  .

The following action icons describe [CH/GRP], [ENT], the Keypad keys, and [◀], [▶], [▲], and [▼]

- Rotate : Rotate [CH/GRP] to select.
- Push : Push [ENT] to enter or set.
- Push : Push the Keypad keys to enter a digit or text.
- Push : Push [◀], [▶], [▲], or [▼] to select.

Icom is not responsible for the destruction, damage to, or performance of any Icom or non-Icom equipment, if the malfunction is because of:

- Force majeure, including, but not limited to, fires, earthquakes, storms, floods, lightning, other natural disasters, disturbances, riots, war, or radioactive contamination.
- The use of Icom transceivers with any equipment that is not manufactured or approved by Icom.

Icom and the Icom logo are registered trademarks of Icom Incorporated (Japan) in Japan, the United States, the United Kingdom, Germany, France, Spain, Russia, Australia, New Zealand, and/or other countries.

**NOTE:** Before transmitting, monitor the channel you want to use to avoid interrupting communications already in progress.

**• CALL PROCEDURE**

Calls must be properly identified and the time limit must be respected.

1. Give your call sign each time you call another ship or coast guard station. If you have no call sign, identify the station by giving your ship name and the name of the licensee.
2. Give your call sign at the end of each transmission that lasts more than 3 minutes.
3. You must break and give your call sign at least once every 15 minutes during long ship-to-shore calls.
4. Keep your unanswered calls short, less than 30 seconds. Do not repeat a call for 2 minutes.
5. Unnecessary transmissions are not allowed.

**• PRIORITIES**

1. Read all rules and regulations pertaining to priorities and keep an up-to-date copy handy. Safety and Distress calls take priority over any other calls.
2. False or fraudulent Distress signals are prohibited and punishable by law.

**• PRIVACY**

1. Information overheard but not intended for you, cannot lawfully be used in any case.
2. Indecent or profane language is prohibited.

**• LOGS**

1. All Distress, Emergency and Safety calls must be recorded in complete details. Log data activity is usually recorded for 24 hours. Universal Time Coordinated (UTC) is frequently used.
2. Keep adjustments, repairs, channel frequency changes and authorized modifications affecting electrical operation of the equipment in the maintenance log. The entries requires signatures by the authorized licensed technician performing or supervising the work.

**• RADIO LICENSES****(1) SHIP RADIO STATION LICENSE**

You need a current ship radio station license before using the transceiver. It is unlawful to operate a ship radio station which is not licensed, but required to be.

If required, contact your dealer or the appropriate government agency for a Ship-Radiotelephone license application. This government-issued license states the call sign which is your craft's identification for radio communication purposes.

**(2) OPERATOR'S LICENSE**

A Restricted Radiotelephone Operator Permit is the license most often held by small vessel radio operators when a radio is not required for safety purposes.

If required, the Restricted Radiotelephone Operator Permit must be posted or kept with the operator. If required, only a licensed radio operator may operate a transceiver.

However, non-licensed individuals may talk over a transceiver if a licensed operator starts, supervises, ends the call and makes the necessary log entries.

A current copy of the applicable government rules and regulations is only required to be on hand for vessels in which a radio telephone is compulsory. However, even if you are not required to have these on hand it is your responsibility to be thoroughly acquainted with all pertinent rules and regulations.

## ■ Main unit

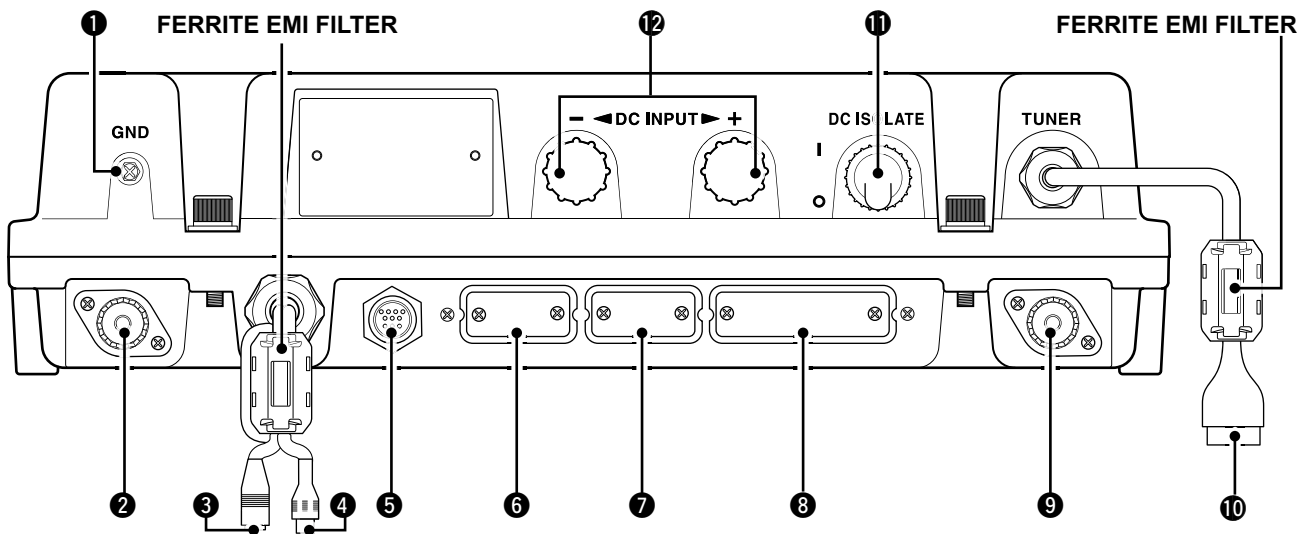

### 1 GROUND TERMINAL [GND]

Connects to the vessel's ground. (p. 77)

### 2 DSC ANTENNA CONNECTOR

Connects to a 50 Ω HF marine band antenna through a 50 Ω PL-259 coax for a DSC receiver. This antenna is used for receiving Distress calls.

**NOTE:** To receive a Distress call, **BE SURE** to connect an HF marine band antenna to this antenna connector. Otherwise, you cannot receive any Distress calls.

### 3 SPEAKER JACK [SP]

Connects to the SP-24E (p. 75) or an external speaker.

**NOTE:** When using an external speaker, **BE SURE** to turn OFF the Speaker Output function. (p. 14) Audio is output from the external speaker only when the internal speaker is OFF.

### 4 GPS JACK [GPS]

Connects to a GPS receiver to input position and UTC data for DSC operations. (IEC 61162-1 Ed.5 (2016-08))

- An IEC 61162-1 Ed.5 (2016-08) (sentence formatter: GGA) compatible GPS receiver is required. Ask your dealer about suitable GPS receivers.

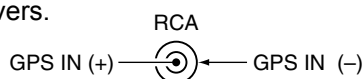

### 5 CONTROLLER CONNECTOR [CONTROLLER]

Connects to the supplied remote controller.

### 6 MODEM CONNECTOR [AF/MOD] (p. 83)

Connect to an external terminal unit for SSB mode operation through an RS-232C cable (D-sub 15-pin).

**NOTE:** When connecting an external unit, detach the cover.

### 7 REMOTE CONNECTOR [REMOTE] (p. 84)

- Connect to a PC through an RS-232C cable (D-sub 9-pin) for remote control.
- Connects to IEC 61162-1 In/Out lines of the CAM system to send the transceiver's BAM information to the CAM system.

**NOTE:** When connecting a PC, detach the cover.

### 8 PRINTER CONNECTOR (p. 84)

Connect to an IBM® Centronics or compatible printer to automatically or manually print out received DSC information.

**NOTE:** When connecting a printer, detach the cover.

### 9 ANTENNA CONNECTOR

Connect to a wire or whip antenna through the AT-141 HF AUTOMATIC ANTENNA TUNER. The antenna is used for transmitting any calls and receiving any calls other than Distress calls.

**⚠ WARNING! NEVER** directly connect the antenna to this connector.

### 10 TUNER CONTROL SOCKET [TUNE]

Connect to the control cable of the supplied AT-141 HF AUTOMATIC ANTENNA TUNER. A female connector kit is supplied to connect the AT-141.

### 11 POWER SWITCH [DC ISOLATE]

Turns the transceiver's main power ON or OFF.

### 12 DC POWER TERMINALS

Connect to a 24 V DC power source through the supplied DC power cables. The red terminal is positive (+), and the black terminal is negative (-).

1  
2

## Remote Controller front panel

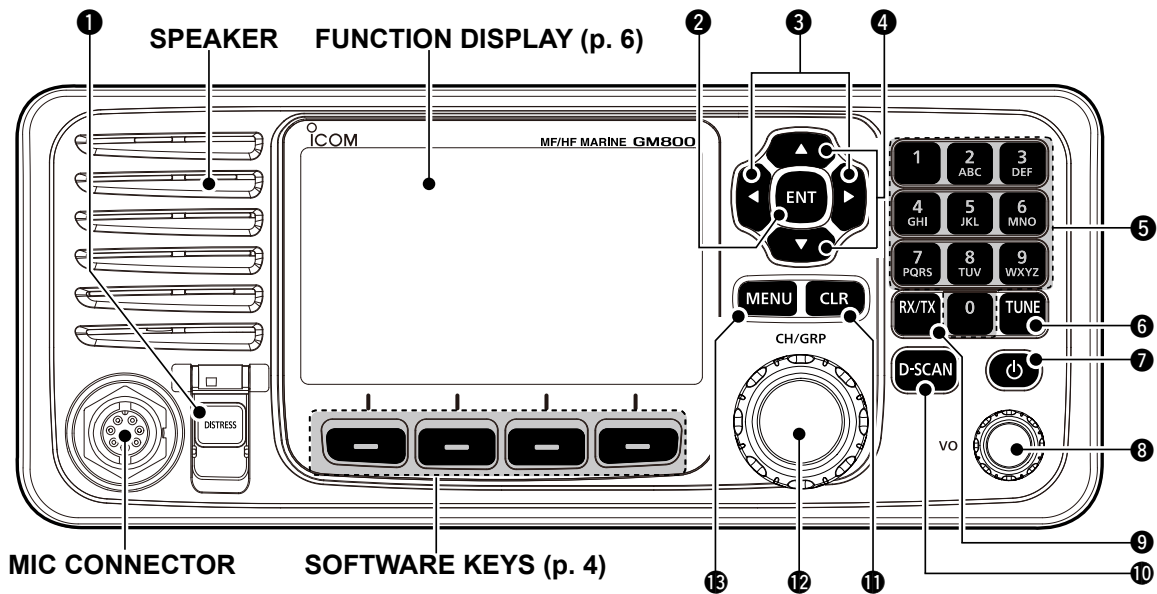

- 1 DISTRESS KEY [DISTRESS]**  
Hold down for 3 seconds to transmit a Distress call. (p. 26)
- 2 ENTER KEY [ENT]**  
Push to set the entered data, selected item, and so on.
- 3 LEFT AND RIGHT KEYS [◀]/[▶]**
  - Push to scroll the Software Key functions. (p. 4)
  - In the Character or Number Entry mode, push to select a character or number in the table.
- 4 UP AND DOWN KEYS [▲]/[▼]**  
Push to select an operating channel, menu items, menu settings, and so on.
- 5 KEYPAD**  
Push to enter numbers, letters, or symbols.
- 6 TUNE KEY [TUNE]**
  - Push to turn ON the Automatic Antenna Tuner function, or to go through (bypass) the tuning circuit. (p. 14)
  - Hold down to start manual tuning.
    - ① "TUNE" is displayed after tuning is completed.
    - ① "THRU" is displayed if the tuner cannot tune the antenna.
- 7 POWER KEY [⏻]**  
Hold down for 1 second to turn the transceiver ON or OFF.

- 8 VOLUME DIAL [VOL]**
  - Rotate to adjust the speaker volume level.
  - Push 1 ~ 5 times to display the setting screens.

Pushing once	The Volume Setting window is displayed.
Pushing twice	The Backlight Settings window is displayed.
Pushing 3 times	The NB Level Setting window is displayed.
Pushing 4 times	The S-SQL Level Setting window is displayed.
Pushing 5 times	The RF Gain Setting window is displayed.

① The number of times [VOL] is pushed is the default value.

- 9 RX/TX KEY [RX/TX]**  
Push to set a temporary operating frequency. (p. 14)
- 10 DSC SCAN KEY [D-SCAN]**  
Push to start a DSC scan. (p. 10)
- 11 CLEAR KEY [CLR]**  
Push to cancel the entered data or to return to the previous screen.
- 12 CHANNEL/GROUP SELECTOR [CH/GRP]**
  - Push to select the Channel Select mode or the Group Select mode. (p. 9)
  - Push to set the entered data, selected item, and so on.
  - Rotate to select the operating channel, menu items, menu settings, and so on.
- 13 MENU KEY [MENU]**  
Push to enter or exit the Menu screen.



## ■ Handset (HS-98)





### ◇ About the Speaker Switch

**When the switch is set to the “” position:**  
You can hear the received audio from the remote controller’s speaker.

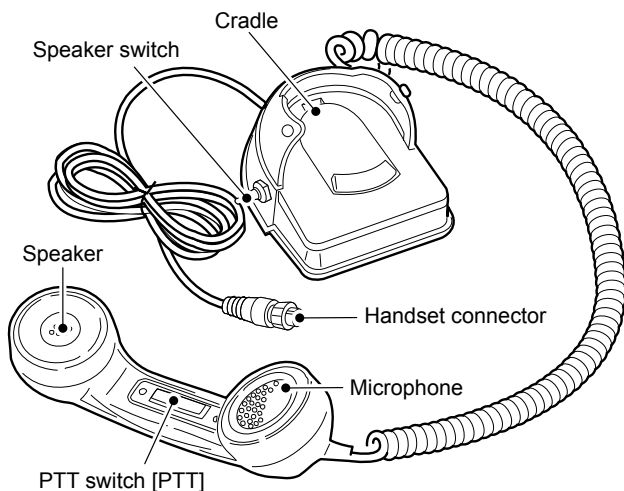
**When the switch is set to the “” position:**  
Mutes the remote controller’s speaker output.  
• You can hear the received audio from the handset.

Put the handset into the cradle to output the received audio from the remote controller’s speaker.



HS-98		The received audio is heard from:	
Status	Speaker switch	GM800 Remote controller’s speaker	HS-98
On hook		Yes	Yes
		Yes	No
Off hook		Yes	Yes
		No	Yes

## ■ Optional HM-214H

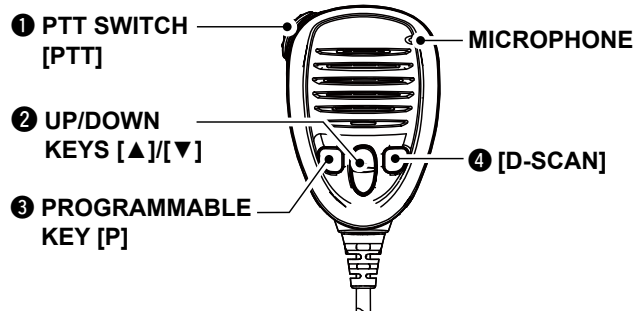

- 1 **PTT SWITCH**  
Hold down to transmit, release to receive.
- 2 **UP/DOWN KEYS [▲]/[▼]**  
Push to select an operating channel or group.

- 3 **PROGRAMMABLE KEY [P]**  
Push to activate the preset Software Key function. Ask your dealer for details.  
① You can reassign some Software Key functions to the key. (p. 16)
- 4 **DSC SCAN KEY [D-SCAN]**  
Push to start the DSC scan. (p. 10)

## ■ Software Key function

Various often-used functions are assigned to the Software Keys for easy access. The function’s icons are displayed above the Software Keys, as shown below.

### ◇ Selecting the Software Key function

Push [◀] or [▶] to slide through the selectable functions that are assigned to the Software Keys. To select the function, push the Software Key under the function’s icon.

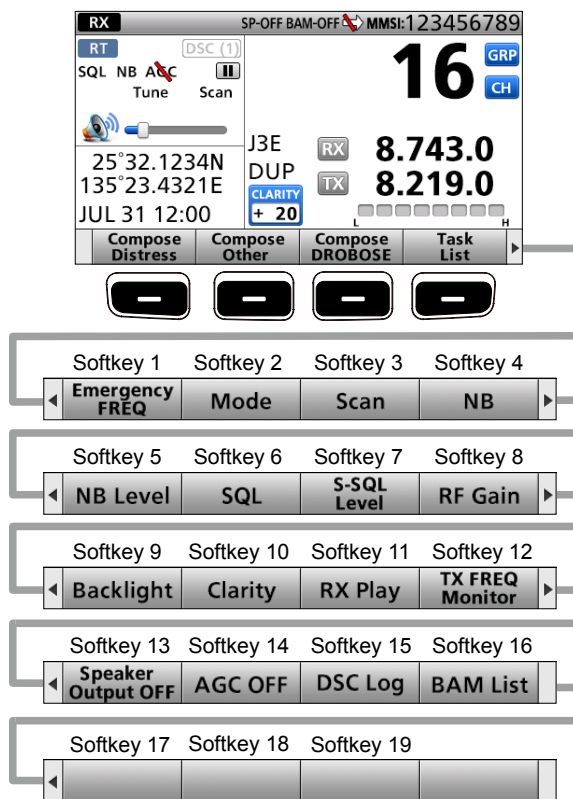

① The key function may differ, depending on the transceiver version or presetting.

### ■ Software Key function

#### ◇ Functions

You can use various Software Key functions that are assigned to the Software Keys, as described below.

---

#### Compose Distress

Push to compose a Distress call. (pp. 26 ~ 36)

---

#### Compose Other

Push to compose DSC calls other than Distress calls. (pp. 37 ~ 50)

---

#### Compose DROBOSE

Push to compose a Distress Relay On Behalf Of Someone Else (DROBOSE) call. (p. 32)

---

#### Task List

Push to display the Task List screen. (p. 25)

---

#### Emergency FREQ

Push to use the Distress Voice Frequency. (p. 13)

---

#### Mode

Push to select the J3E, H3E, LSB, J2B, F1B, or A1A operating mode.

---

#### Scan

Push to start or stop a scan. (p. 12)

---

#### NB

Push to turn the Noise Blanker (NB) function ON or OFF. (p. 13)

---

#### NB Level

Push to adjust the Noise Blanker (NB) level. (p. 13)

---

#### SQL

Push to turn the Squelch function ON or OFF. (p. 13)

---

#### S-SQL Level

Push to adjust the S-meter Squelch (S-SQL) level. (p. 13)

---

#### RF Gain

Push to adjust the Radio Frequency (RF) gain level. (p. 13)

---

#### Backlight

Push to change the brightness of the backlight. (p. 11)

---

#### Clarity

Push to turn the Clarity Control function ON or OFF. (p. 13)

---

#### RX Play

Push replay the recorded audio data (p. 13)

---

#### TX FREQ Monitor

Push to check and monitor the transmit frequency. (p. 13)

---

#### Speaker Output OFF

Push to turn the speaker output ON or OFF. (p. 14)

---

#### AGC OFF

Push to turn the Automatic Gain Control (AGC) function ON or OFF. (p. 14)

---

#### DSC Log

Push to check the received DSC calls. (p. 62)

---

#### BAM List

Push to display the received alerts. (p. 13)

①When the BAM function is turned OFF, the BAM List is not displayed.

**TIP:** You can reassign the function's place to meet your needs between Softkey 1 and Softkey 19. See page 16 for details.

①The first set of Software Key functions ([Compose Distress], [Compose Other], [Compose DROBOSE], and [Task List]) are fixed and cannot be reassigned.

①When the MMSI code is not set, the Software Keys for the DSC function are not displayed.

## Function display (Main screen)

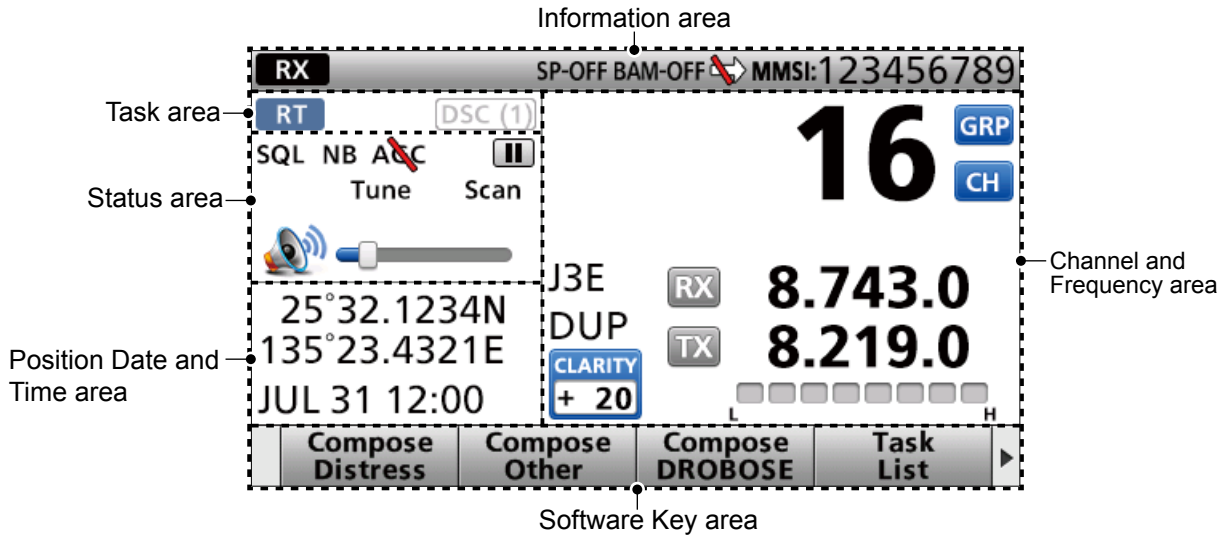

### ◇ Status area

The current status is displayed in the Status area.

Indication	Description
SQL	Displayed when the Squelch function is ON.
NB	Displayed when the Noise Blanker function is ON.
<del>AGC</del>	Displayed when the AGC function is OFF.
NR	Displayed when the Noise Reduction function is ON.
	• Displayed when the received audio is recorded. (p. 12)
	• Displayed when recording the received audio is stopped. (p. 12)
Tune	Displayed when the Tune function is ON.
Scan	Displayed during a scan.
	• Displayed when the volume is set to between 1 to 20.
	• Displayed when the volume is set to 0.

### ◇ Task area

Task icons are displayed in the Task area when the transceiver has tasks.

Indication	Description
RT	Displayed while in the Radio Telephone (RT) mode. <ul style="list-style-type: none"> <li>• "RT" is displayed when the RT mode task is on hold.</li> <li>• Returns to the Standby mode if no operation occurs during the preset period of time.</li> </ul>
DSC (1)	Displayed after making or receiving a DSC call. <ul style="list-style-type: none"> <li>• "DSC (1)" is displayed when the DSC task is on hold.</li> <li>• The number of DSC tasks is displayed by the indicator.</li> </ul>









### ◇ Channel and Frequency area

Indication	Description
CH	Displayed when the Channel Select mode is selected.
GRP	Displayed when the Group Select mode is selected.
CLARITY + 20	Displayed when the Clarity function is ON. The number is the added to (+) or subtracted from (-) the frequency.
Emergency	Displayed when the Emergency FREQ channel is selected.
	When receiving, the S meter displays the relative signal strength.
	When transmitting, the Current meter displays the output power level.
SIMP	Displayed when a Simplex channel is selected.
DUP	Displayed when a Duplex channel is selected.
J3E/H3E/LSB/J2B/F1B/A1A	Displays the selected operating mode.

■ **Function display (Main screen)**

◇ **Information area**

The 9 digit MMSI (Maritime Mobile Service Identity: DSC self ID) code and the following indications are displayed in the Information area.

Indication	Description
	Displayed while receiving a signal or when the squelch is open.
	Displayed while transmitting.
	<ul style="list-style-type: none"> <li>Displayed when the GPS receiver is activated and valid position data is received.</li> <li>Blinks while invalid position data is being received.</li> </ul>
	<ul style="list-style-type: none"> <li>Displayed when there are unread DSC messages.</li> <li>Blinks when a DSC message is received.</li> </ul>
	Displayed when the "CH Auto Switch" in DSC settings is set to an option except "Accept after 10 sec.."
	Displayed when the internal speaker is OFF.
	Displayed when the BAM function is OFF. (72)
	Displayed when the BAM alert is received. ① The icon varies, depending on the alert's priority and status. (p. 20)

◇ **Software Key area**

The Key function for each Software Key is displayed. See page 4 for details.

◇ **Position and Time area**

**POSITION AREA**

The current position is displayed when valid GPS data has been received, or the position was manually entered.

Indication	Description
<b>No Position</b>	Displayed when a GPS receiver is not connected and the position data has not been manually entered.
<b>??</b>	Blinks every 2 seconds instead of the position when the GPS position data is not correctly received. <ul style="list-style-type: none"> <li>The last position is held for only 23.5 hours. After that, "No Position" will be displayed.</li> </ul>
	Blinks every 2 seconds instead of the position after 4 hours have passed since the position data was manually entered. <ul style="list-style-type: none"> <li>The manually entered position is held for only 23.5 hours. After that, "No Position" will be displayed.</li> </ul>

**DATE AND TIME AREA**

- The current time is displayed when valid GPS data has been received, or the time was manually entered.
- The date information is displayed when the RMC GPS sentence formats are included in the GPS signal.

Indication	Description
<b>No Time</b>	Displayed when a GPS receiver is not connected and the time has not been manually entered.
<b>Local</b>	Displayed when the offset time is set.
<b>Manual</b>	Displayed when the time was manually entered.
<b>UTC</b>	Displayed when the GGA, GLL or GNS GPS sentence formats are included in the GPS signal.
<b>??</b>	Blinks every 2 seconds instead of the time when the GPS current time is not correctly received. <ul style="list-style-type: none"> <li>After 23.5 hours has passed, "No Time" will be displayed.</li> </ul>
	Blinks every 2 seconds instead of the time after 4 hours have passed since the time was manually entered. <ul style="list-style-type: none"> <li>The manually entered time is held for only 23.5 hours. After that, "No Time" will be displayed.</li> </ul>

## ■ Entering the MMSI code

The Maritime Mobile Service Identity (MMSI: DSC self ID) code consists of 9 digits. You can only enter the code when turning ON the transceiver for the first time.

**This initial code can be entered only once.**  
 After entering, it can be changed only by your dealer or distributor.  
 If your MMSI code has already been entered, doing the steps below is not necessary.

1. Hold down [⏻] for 1 second to turn ON the transceiver.
  - Three short beeps sound, and “Push [ENT] to Register Your MMSI” is displayed.

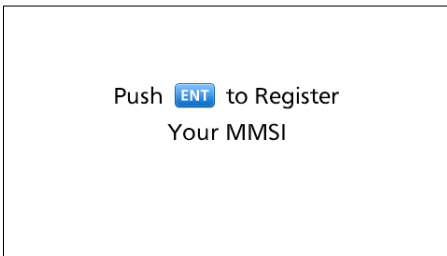

2. Push [ENT] to start entering the MMSI code.
  - The “MMSI Input” screen is displayed.
  - ① To skip the entry, push [CLR] twice.  
 If you skip the entry, you cannot make a DSC call. To enter the code after skipping, turn OFF the power, and then turn it ON again.

3. Enter the MMSI code.

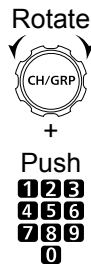
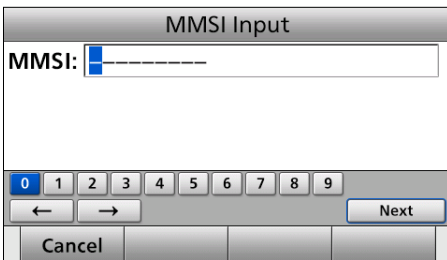

4. Repeat step 3 to enter all 9 digits.
5. Push [ENT] to set the entered code.

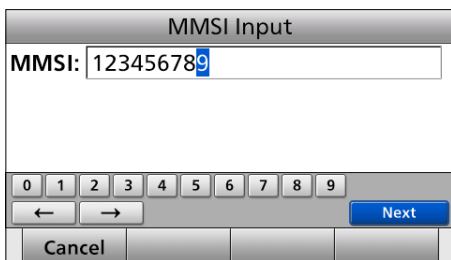

- The “MMSI Confirmation” screen is displayed.

6. Enter your MMSI code again to confirm.



7. Push [ENT] to set the confirmation code.



- When your MMSI code is successfully entered, the following screen is displayed.



- After that, the Main screen is displayed. The registered MMSI code is displayed at the top of the screen.

2  
3

## ■ Selecting a Channel or Group

### ◇ Using the channel and group selector

1. Push [CH/GRP] to toggle between the Channel Select mode or the Group Select mode.
  - [CH] or [GRP] is displayed.

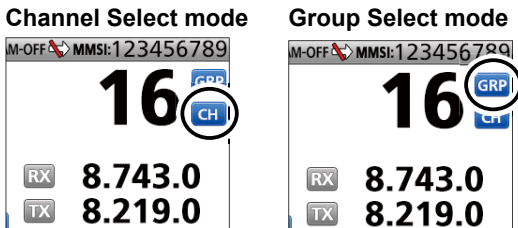

2. Rotate [CH/GRP] to select a channel or group.
  - ① When selecting the Group Select mode, the User channels change in 20 channel steps.

**NOTE:** See the Channel and Channel Group list below.

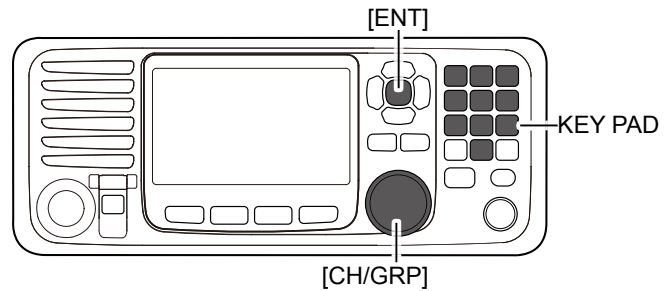

### ◇ Using the keypad

#### • When selecting a User channel or an ITU duplex channel

1. Push the keypad keys to enter the channel number.
2. Push [ENT] to set.

**Example**  
 Selecting CH 1: [1] → [ENT]  
 Selecting CH 41: [4] → [1] → [ENT]  
 Selecting CH 101: [1] → [0] → [1] → [ENT]  
 Selecting CH 2505: [2] → [5] → [0] → [5] → [ENT]

**NOTE:**  
 • See the Channel and Channel Group list to the right.  
 • Pushing [CLR] clears the entered digits and return to the previous channel.

#### • When selecting an ITU simplex channel or an ITU C1 or C2 channel

1. Push the keypad keys to select a frequency band.
  - ① To select an ITU C1 or C2 channel, push “1” or “2.”
2. Push the left most Software Key to enter “-” (dash).
3. Push the keypad keys to enter the channel number.

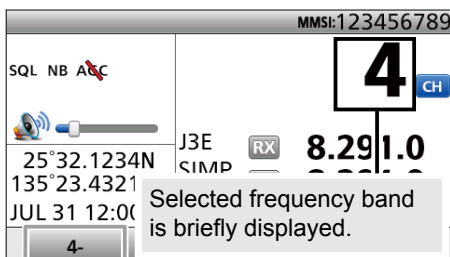

4. Push [ENT] to set.

**Example**  
 • Selecting CH 4-1: [4] → [ - ] → [1] → [ENT]  
 • Selecting CH 25-2: [2] → [5] → [ - ] → [2] → [ENT]

#### • Channel and Channel Group list

Channel No.	Description
1 ~ 160	User CH*
401 ~ 429	4 MHz ITU duplex CH
4-1 ~ 4-9	4 MHz ITU simplex CH
601 ~ 608	6 MHz ITU duplex CH
6-1 ~ 6-9	6 MHz ITU simplex CH
801 ~ 837	8 MHz ITU duplex CH
8-1 ~ 8-9	8 MHz ITU simplex CH
1201 ~ 1241	12 MHz ITU duplex CH
12-1 ~ 12-9	12 MHz ITU simplex CH
1601 ~ 1656	16 MHz ITU duplex CH
16-1 ~ 16-9	16 MHz ITU simplex CH
1801 ~ 1815	18 MHz ITU duplex CH
18-1 ~ 18-9	18 MHz ITU simplex CH
2201 ~ 2253	22 MHz ITU duplex CH
22-1 ~ 22-9	22 MHz ITU simplex CH
2501 ~ 2510	25 MHz ITU duplex CH
25-1 ~ 25-9	25 MHz ITU simplex CH
C1-1 ~ C1-21	ITU C1 channels
C2-1 ~ C2-31	ITU C2 channels

\* [GRP] changes in 20 channel steps.

## Receiving and transmitting

### Receiving

1. Select a channel by rotating [CH/GRP], or pushing the Keypad keys. (p. 9)
2. When receiving a call, rotate [VOL] to adjust the audio output level.

**TIP:**

When a call is received:

- **RX** is displayed.
- You can hear receive audio from the speaker.
- The S-meter displays the received signal strength.

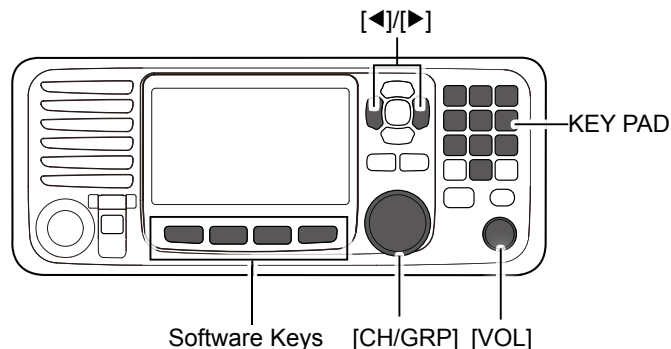

### Transmitting

1. Select a channel by rotating [CH/GRP] or pushing the keypad keys. (p. 9)
2. Push [◀] or [▶] to until "TX FREQ Monitor" is displayed in the Software Key area.
3. Hold down [TX FREQ Monitor] to temporarily monitor the transmit frequency of the selected channel.
  - **TX** blinks while holding down.

**NOTE:** If the channel is busy, wait until it becomes clear, or change to another channel.

4. Hold down [PTT] on the handset and speak into the microphone at your normal voice level.
  - **TX** blinks while holding down.

**NOTE:** If "SWR" is displayed during the transmission, check your antenna system.

5. Release [PTT] to receive.
  - **RX** is displayed.

**NOTE: For the Time-out Timer (TOT) function**

The TOT function inhibits continuous transmission beyond a preset time period after the transmission starts. 10 seconds before transmission is cut off, a beep sounds to indicate the transmission will be cut off. Release [PTT] once to end your transmission and reset the timer. You cannot transmit for 10 seconds after it is cut off.

**TIP:** To maximize the readability of your transmitted signal, pause for a second after holding down [PTT]. Hold the microphone 5 to 10 cm from your mouth, and then speak at your normal voice level.

## DSC scan

To receive a DSC call, such as an Individual call or a Group call, push [D-SCAN] to enter the DSC Watch mode.

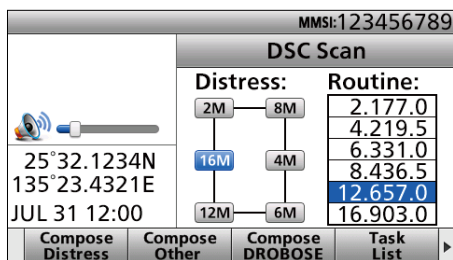

DSC Watch mode

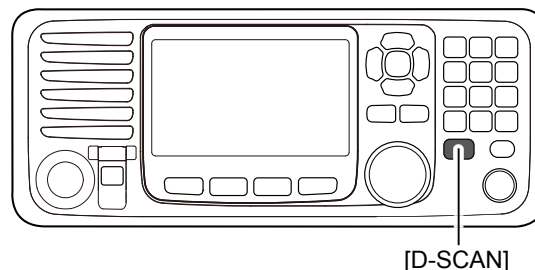

**NOTE:** The following frequencies are always automatically monitored with this transceiver.

2187.5, 4207.5, 6312.0, 8414.5, 12577.0, and 16804.5 kHz

① The setting for monitoring these frequencies can be changed in the Scanning Receiver setting. (p. 64)

## ■ Backlight function

The function display and keys can be backlit for better visibility under low light conditions.

You can set the Backlight mode to Day Mode, Night Mode, or Auto mode. Day mode is for the daytime operation, and the screen items are in color. Night mode is for the nighttime operation, and the screen items are in black and red.

The Auto mode automatically changes the display mode to Night Mode while in Night Mode Time.

1. Push [◀] or [▶] until "Backlight" is displayed in the Software Key area.
2. Push [Backlight]  to open the Backlight Settings window.
  - ① You can also display the window by pushing [VOL] twice (default).

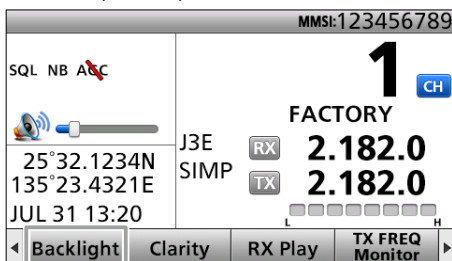

3. Push [▲] or [▼] to select "Day Mode," "Night Mode," or "Auto."

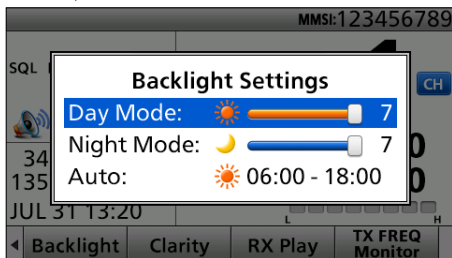

- ① If you push no key for about 5 seconds in the Backlight Settings window, the transceiver automatically returns to the Main screen.
4. Adjust the backlight brightness level.

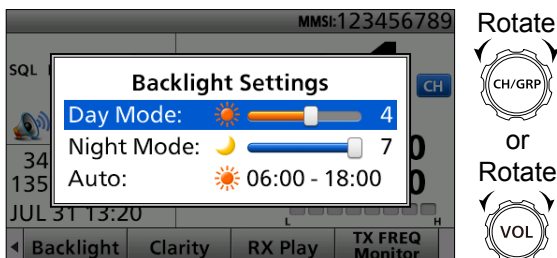

- ① The backlight brightness level is adjustable in 7 levels and "OFF." "OFF" is selectable only in Day Mode.
5. Push [ENT] or [VOL] to exit the the Backlight Settings window.

**TIP:** You can also set the Backlight mode in the "Display item." (p. 71)



## ■ Instant Replay function

The transceiver has an Instant Replay function that can record the last 120 seconds of the received audio.

You can playback the audio that you could not hear.

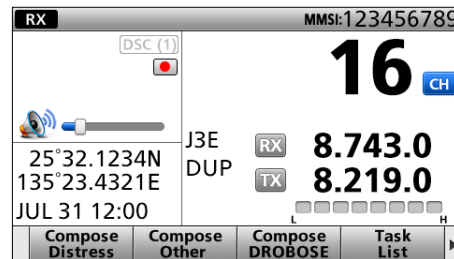
- Starts recording automatically when the signal is received.



-  is displayed when recording the received audio.
- Stops recording 3 seconds after the signal disappears or when the channel is changed.
-  is displayed when recording is stopped.
- If the length of recorded audio exceeds 120 seconds, the old audio will be overwritten.
- The recorded audio is deleted when the transceiver is turned OFF.



## ◇ Playback the recorded voice

You can set the play start point in the "Play Time" setting before playing. (p. 73)

1. Push [◀] or [▶] until "RX Play" is displayed in the Software Key area.
2. Push [RX Play]  to play the recorded audio.
  - The recorded audio automatically starts playing.
  - The play window is displayed as shown below.



### TIP:

- To stop playing the recorded audio, push [CH/GRP].
  -  is displayed.
  - ① Push [CH/GRP] again to restart play.
    - When the recorded audio is played,  is displayed.
- Rotate [CH/GRP] to adjust the play start point in 5 second steps.
  - ① Set between -2'00 to 0'00.
- Rotate [VOL] to adjust the volume level.
  - ① Set to between 0 (OFF) and 20.
- After playing the audio to 0'00, return to the play start point set in the "Play Time."
- When the play window is displayed, recording the newly received audio is stopped.



## ■ Scan

The transceiver has automatic channel or frequency scan capabilities (Scan function). There are 3 types of scan functions.

- Channel
- Channel Resume scan
- Program

### ◇ Channel and Channel Resume scan

The Channel and Channel Resume search within a 20 channel range, such as channel 1 to channel 20, in the user channels, and search all channels in the same bandwidth in the ITU channels.

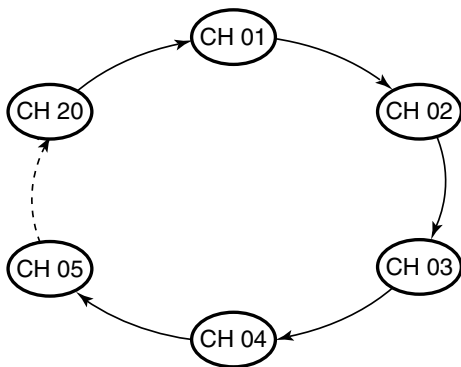

#### Channel scan:



The scan does not pause, even if a signal is received.

#### Channel Resume scan:

The scan pauses for 10 seconds, then resumes, or resumes after 2 seconds from when the signal disappears.

To use the Channel scan or Channel Resume scan, select “Channel” or “Channel Resume” in “Type” on the Menu screen. (p. 73)

[MENU] > Settings > Radio > Scan > **Type**

1. Rotate [GRP/CH] to select a channel group. (p. 9)
2. Push [◀] or [▶] until “Scan” is displayed in the Software Key area.
3. Push [Scan]  to start a scan.
4. Push [Scan]  again to stop the scan.

### ◇ Program scan

The Program scan searches the selected channel within the frequency range.

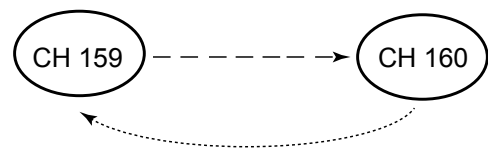



#### Example:

Scans the frequencies between CH 159 and 160.  
Scans quickly when the squelch is closed.  
Scans slowly when the squelch is open.

To use the Program scan, select “Program” in “Type” on the Menu screen. (p. 73)

[MENU] > Settings > Radio > Scan > **Type**

1. Push [◀] or [▶] until “SQL” is displayed in the Software Key area.
2. Push [SQL]  to turn OFF the squelch function.
3. Push [◀] or [▶] until “Scan” is displayed in the Software Key area.
4. Push [Scan]  to start a scan.
5. Push [Scan]  again to stop the scan.

## Other functions

### Emergency FREQ channel

Select the Distress Voice Frequency. When this channel is selected, the Voice Frequency of a DSC call can be monitored without receiving or transmitting a DSC call.

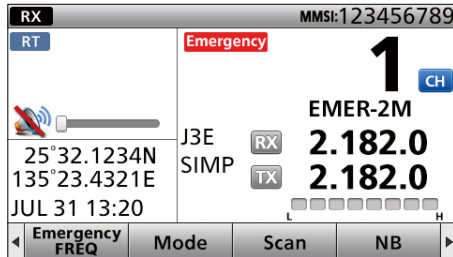

1. Push [◀] or [▶] until [Emergency FREQ] is displayed in the Software Key area.
2. Push [Emergency FREQ].
  - The channel is changed to an Emergency FREQ channel and **Emergency** is displayed in the Channel area.
3. Rotate [CH/GRP] or push [▲] or [▼] to select a channel.
  - ① Push [Emergency FREQ] again to exit the Emergency FREQ channel.

### Noise Blanker function

The Noise Blanker function reduces pulse-type noises that come from engine ignitions. However, if the received strong signals are distorted, adjust the Noise blanker level or turn OFF the function.

1. Push [◀] or [▶] until [NB] is displayed in the Software Key area.
2. Push [NB] to turn the function ON or OFF.
  - ① When the function is ON, "NB" is displayed.

### Noise Blanker level

When the Noise Blanker function is ON, adjust the Noise Blanker level to reduce various pulse-type noises. Set to between 1 and 10.

1. Push [◀] or [▶] until [NB Level] is displayed in the Software Key area.
2. Push [NB Level] .
  - The NB level setting window is displayed.
  - ① You can also display the window by pushing [VOL] 3 times (default).
3. Rotate [VOL] to adjust the Noise Blanker level.

### Squelch function

The Squelch function mutes unwanted signals, such as noise or unmodulated beat signals. This function enables quiet standby. However, if you need to receive weak signals, adjust the Squelch level, or turn OFF the function.

1. Push [◀] or [▶] until [SQL] is displayed in the Software Key area.
2. Hold down [SQL] to turn the function ON or OFF.
  - ① When the function is ON, **SQL** is displayed in the Status area.

### S-meter squelch level

When the Squelch function is ON, only signals stronger than this set level are received. Set to between 0 (open) and 100 (tight).

1. Push [◀] or [▶] until [S-SQL Level] is displayed in the Software Key area.
2. Push [SQL Level] .
  - The S-SQL level setting window is displayed.
  - ① You can also display the window by pushing [VOL] 4 times (default).
3. Rotate [VOL] to adjust the S-meter squelch level.

### RF Gain level

To receive weak signals, you can set the minimum RF (Radio Frequency) gain level needed. Set to between 0 and 9.

1. Push [◀] or [▶] until [RF Gain] is displayed in the Software Key area.
2. Push [RF Gain] .
  - The RF Gain level setting window is displayed.
  - ① You can also display the window by pushing [VOL] 5 times (default).
3. Rotate [VOL] to adjust the RF Gain level.

### Clarity Control function

With the Clarity Control function, you can slightly shift the receive frequency without changing the operating transmit frequency to finely tune it. When the function is ON, adjust the receive frequency. Set to between -150 Hz and +150 Hz (in 10 Hz steps).

1. Push [◀] or [▶] until [Clarity] is displayed in the Software Key area.
2. Push [Clarity] to turn the function ON.
  - ① is displayed in the Channel area.
3. Rotate [CH/GRP] or push [▲] or [▼] to adjust the receive frequency.

### Transmit Frequency Monitor function

When selecting a duplex channel, the transmit frequency differs from the receive frequency. To prevent interference to other stations, the transmit frequency should be monitored before you transmit.

1. Push [◀] or [▶] until [TX FREQ Monitor] is displayed in the Software Key area.
2. Hold down [TX FREQ Monitor] to monitor the transmit frequency.
  - ① blinks while holding down.

### Speaker Output function



When the Speaker Output function is ON, an internal speaker is turned ON.

1. Push [◀] or [▶] until [Speaker Output OFF] is displayed in the Software Key area.
2. Push [Speaker Output OFF]  to turn the function ON or OFF.
  - ① When the function is OFF, **SP-OFF** is displayed.

### Automatic Gain Control OFF

The Automatic Gain Control (AGC) function prevents distortion from strong signals and maintains a constant output level.

To receive weak signals, turn OFF the function.

1. Push [◀] or [▶] until [AGC OFF] is displayed in the Software Key area.
2. Push [AGC OFF]  to turn the function OFF.
  - ① When the function is OFF, "~~AGC~~" is displayed.
  - ① Push [AGC ON]  to turn the function ON again.

### Automatic Antenna Tuner function

When using the AT-141 with the GM800, you can use the Tuner Through function.

- Push [TUNE] to turn ON the Automatic Antenna Tuner function, or to bypass the tuning circuit.
- Hold down [TUNE] to start manual tuning.
  - ① "TUNE" is displayed after tuning is completed.
  - ① "THRU" is displayed if the tuner cannot tune the antenna.

## ■ Setting a temporary operating frequency

You can temporarily change the operating frequency of the selected channel. The frequency returns to the preset value after you select another channel, or turn OFF the transceiver.

1. Select a channel that is near the frequency you want to receive.
2. Push [RX/TX] to select the RX mode.
  - The RX icon lights blue.
3. Enter an RX frequency.

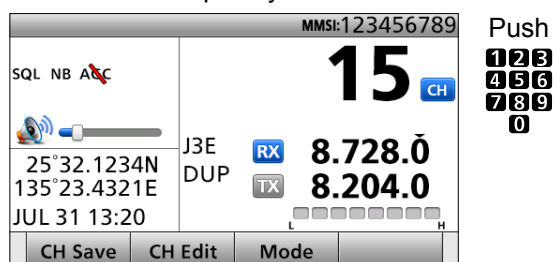

#### TIP:

- Select the digit using [◀] and [▶], and change the value using [▲] and [▼], or rotating [CH/GRP].
- When you select the digit using [◀] and [▶],  is displayed above the selected digit.
- You can directly enter a frequency by using the Keypad keys.

#### NOTE:

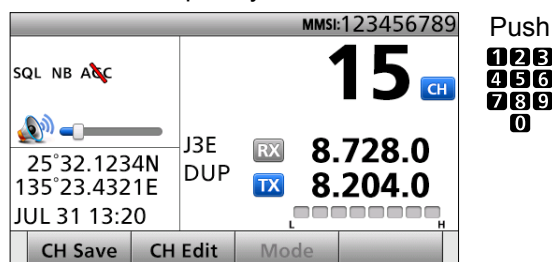

- If you enter a frequency that is out of the frequency range, an error beep sounds, and the channel automatically returns to the preset frequency.
- If you enter a frequency using the Keypad keys and 10 seconds have passed without pressing [ENT], the channel automatically returns to the preset frequency.
- **BE SURE** to push [ENT] after entering the frequency by using the Keypad keys.  
Example: Entering 6520.0 kHz  
[6] → [5] → [2] → [0] → [0] → [ENT]

4. Push [RX/TX] to select the TX mode.
  - The TX icon lights blue.
5. Enter a TX frequency.



- ① See the NOTE in step 3 to enter.
6. Push [RX/TX] to return to the Main screen.

#### TIP:

- If you want to save the entered frequency:
  1. Push [CH Save]  after the frequency is entered.
    - "Are You Sure?" is displayed.
  2. Push [OK] .
    - The setting is saved and returns to the previous screen.
  3. Push [RX/TX] or [CLR].
- If you want to change and save the frequency and other settings of the selected channel, push CH Edit to open the Channel Edit screen. See the next page for details.
- Push Mode to change the operating mode to J3E, H3E, LSB, J2B, F1B, or A1A.

## ■ Setting a User channel or an ITU Simplex channel

Your dealer has already preset User channels and ITU Simplex channels.

Follow the instructions as described below only when you need to edit the channels.

You can edit the following information of a User channel or an ITU Simplex channel.

- Operating frequency
- Operating mode
- Channel name

**NOTE:**

- If you edit the preset channels, you may not be able to communicate with other vessels.
- The following instructions are for User channel Editing. However, you can set an ITU Simplex channel name in the same way.

### Step 1. Entering the Channel Edit screen

1. Open the “User Channel” or “ITU Simplex Channel” screen.

[MENU] > Settings > Radio > **User Channel**

[MENU] > Settings > Radio > **ITU Simplex Channel**

2. Select a channel to edit.

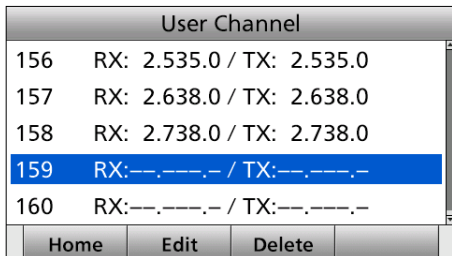

### Step 2. Setting an RX and TX operating frequencies

**NOTE:** The RX and TX operating frequency are the same when an ITU Simplex channel is selected.

1. Select “Frequency.”

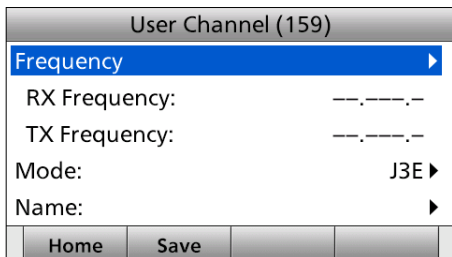

2. Enter an RX frequency.  
After entering, push [▲], [▼], [◀], or [▶] to select “Next” and push [ENT].  
(Example: 4.390.0)

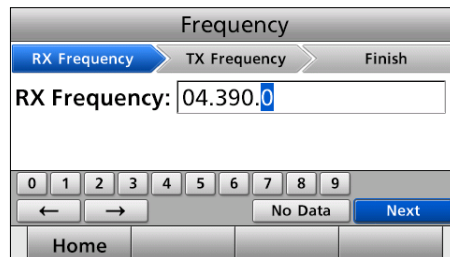

3. Enter a TX frequency.  
After entering, push [▲], [▼], [◀], or [▶] to select “Finish” and push [ENT]. (Example: 4.098.0)

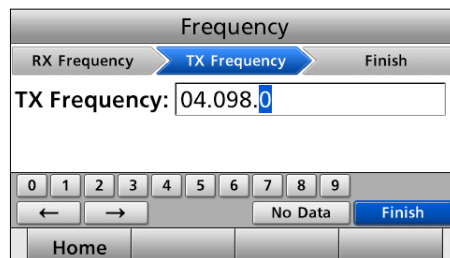

### Step 3. Setting an operating mode

1. Select “Mode.”

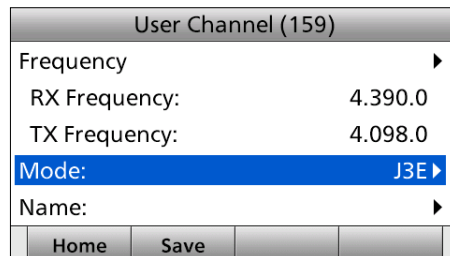

2. Select an operating mode. (Example: J3E)

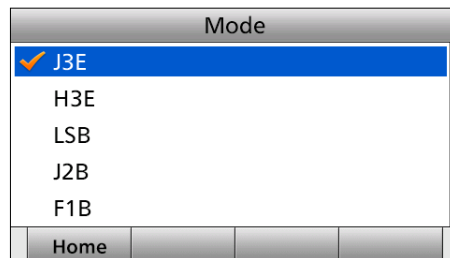

**Step 4. Setting a channel name**

You can set a channel name of up to 10 characters for each User channel and ITU simplex channel. This may be helpful to indicate the frequency's use or a vessel's name.

1. Select "Name."

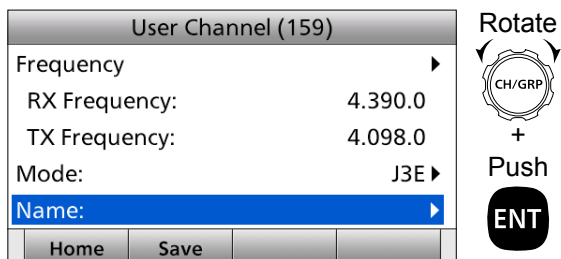

2. Enter a channel name. After entering, push [▲], [▼], [◀], or [▶] to select "Finish" and push [ENT].

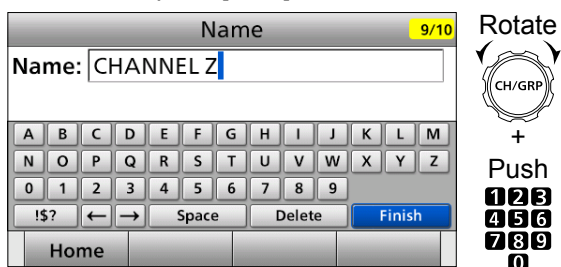

3. Push [Save].
  - "Are you sure ?" is displayed.

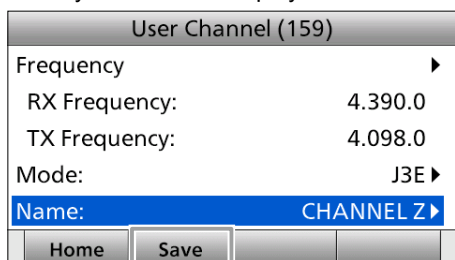

4. Push [OK] to save the edited data.
5. Push [MENU] to return to the Main screen.

**Assigning a function**

You can assign some different Software Key functions to a key between Softkey 1 and Softkey 19. (p. 4)

You can also assign some Software Key functions to [VOL] on the remote controller and [P] on the optional HM-214H MICROPHONE.

**Assigning a Software Key function to a Software Key**

Example: Assigning "NB" to "Softkey 17."

1. Open "Softkey Assignment."

[MENU] > Settings > Configuration > Key Assignment > **Softkey Assignment**

2. Select a software key. (Example: Softkey 17)

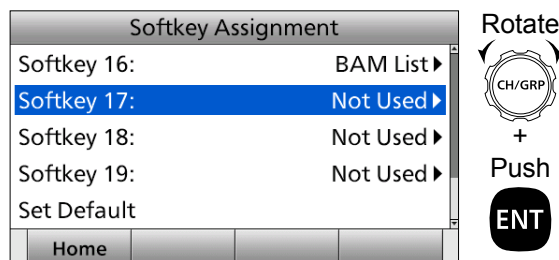

3. Select a Software Key function. (Example: NB)

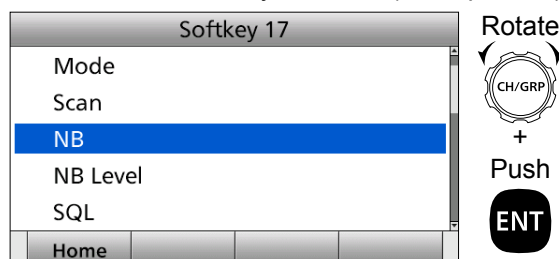

- The selected Software Key function is assigned to the software key.

4. Push [MENU] or [Home] to return to the Main screen.

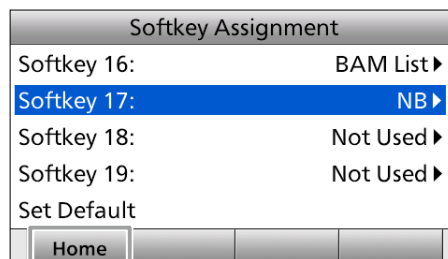

**TIP:** You can confirm the selected function is assigned to the Software Key after returning to the Main screen.

■ Assigning a function

◇ Assigning a Software Key function to [VOL]

Example: Assigning “Backlight” to “Push ×4.”

1. Open “Volume Dial Assignment.”

[MENU] > Settings > Configuration > Key Assignment > **Volume Dial Assignment**

2. Select a place. (Example: Push ×4)

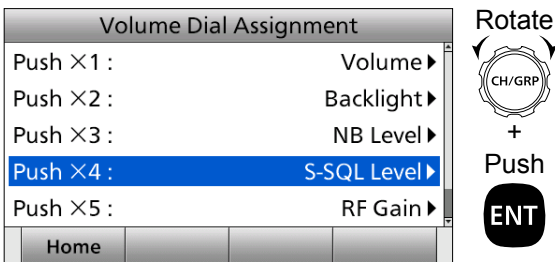

3. Select a Software Key function. (Example: Backlight)

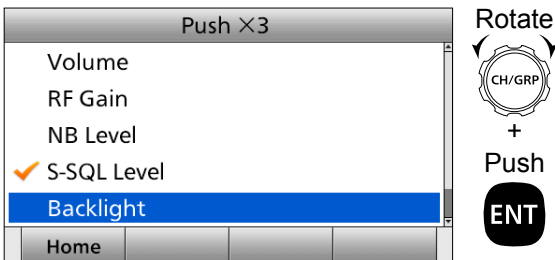

• The selected Software Key function is assigned to [VOL].

4. Push [MENU] or [Home]  to return to the Main screen.

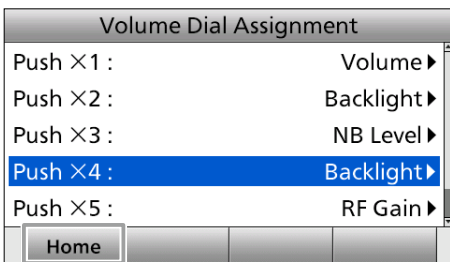

**TIP:** You can confirm the selected function is assigned to the Volume Dial after returning to the Main screen. (Example: When [VOL] is pushed 4 times, the Backlight Settings window is displayed.)

◇ Assigning a Software Key function to [P] on the HM-214H MICROPHONE

Example: Assigning “Mode” to [P].

1. Open “P Key Assignment.”

[MENU] > Settings > Configuration > Key Assignment > **P Key Assignment**

2. Select a Software Key function. (Example: Mode)

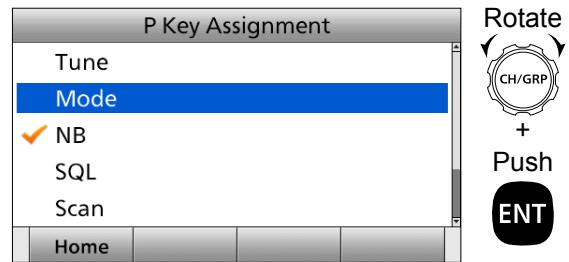

• The selected Software Key function is assigned to [P].

3. Push [MENU] or [Home]  to return to the Main screen.

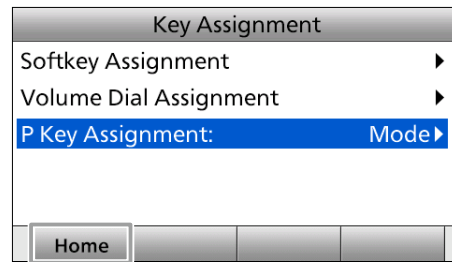

**TIP:** You can confirm the selected function is assigned to [P] after returning to the Main screen.

## ■ Bridge Alert Management (BAM)

Bridge Alert Management (BAM) is the overall concept that the IMO defined for management, handling and harmonized presentation of alerts on the bridge, to enable the bridge team to devote full attention to the safe operation of the vessel and to immediately identify any alert situation requiring action to maintain the safe operation of the vessel.

**NOTE:** The BAM has optional “Functional grouping” and “Aggregation” functions, but the GM800 cannot use these functions.

The transceiver can transmit and receive BAM sentences through the IEC 61162-1 interface. There are two interfaces, one for transmit and one for receive.

When an event related to the BAM concept occurs, you can receive an alert from the transceiver. (p. 19)  
You can check alerts in the BAM list. (p. 20)

When an alert is received:

- An icon is displayed or blinks in the Information area.
- A popup screen is displayed with the icon.

### Example (Receiving a Distress Call):

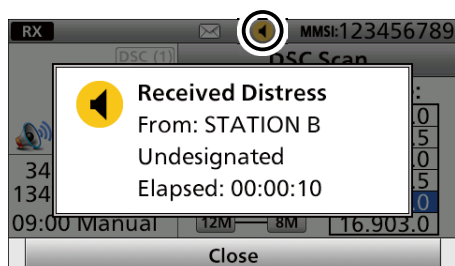

- A popup screen may not be displayed, depending on the presetting.
- Two short beeps may sound, depending on the priority of the alert or the presetting.
- If you do not confirm the alert, two short beeps sound every 90 seconds.  
(Only for the alerts with the priority of “Warning.”)
- See page 20 for details of the icon.
- The icon on the popup screen may change, depending on the alert status.
- When there is more than one alert, the icon with the highest priority alert is displayed in the Information area.

### ◇ Turning ON the BAM function

1. Push [MENU].
2. Select “BAM,” then push [ENT]. (p. 72)

[MENU] > Settings > Configuration > BAM > Function

3. Select “ON,” and then push [ENT].

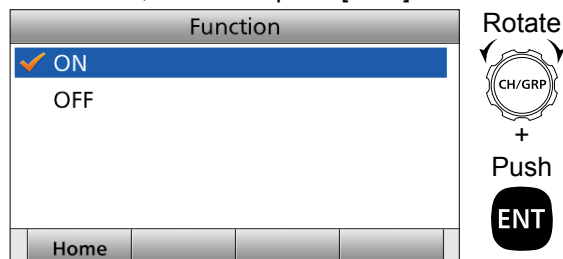

4. Push [MENU] to return to the Main screen.

### ◇ Category

The BAM concept has 3 categories, A, B, and C. You can receive category B alerts.

- B: Alert where no additional information for decision support is necessary besides the information that can be presented at the central alert management (CAM) HMI.

### ◇ Priority

The alerts are classified into 4 priorities, Emergency Alarm, Alarm, Warning, and Caution. You can receive alerts of the “Warning” and “Caution” priorities.

- Warning: A condition requiring immediate attention, but no immediate action by the bridge team. Warnings are presented for precautionary reasons to make the bridge team aware of changed conditions that are not immediately hazardous, but may become so if no action is taken.
- Caution: The lowest priority alert. Awareness of a condition that does not warrant an alarm or warning condition, but still requires attention out of the ordinary consideration of the situation or of given information.

■ Bridge Alert Management (BAM)

◇ Responsibility transfer

The Central Alert Management (CAM) is the system that centrally manages alerts from multiple bridge equipment. The GM800 can be connected to the CAM system.

If the CAM system has additional knowledge regarding an alert situation, which caused the GM800 to raise an alert, it may apply for responsibility transfer.

This will reduce the number of high-priority audible alerts for one situation that requires attention.

In that case, the CAM system will follow the following procedures:

- If practicable, raise a new alert with a lower priority.
- Request the GM800 to accept the transfer of the responsibility for the alert that is raised to report the situation requiring attention.

◇ Alert

You can receive the following alerts from the transceiver.





- See page 93 for details of the alerts.
- See page 18 for details of the category and priority.

When the GM800 receives a request for responsibility transfer from the CAM system:

- The alert status becomes “Active – Responsibility Transferred.”
- No alarms sound.
- The alert is not displayed on the BAM list by default.

**NOTE:** The GM800 can receive the request for responsibility transfer only while receiving a valid HBT sentence from the CAM system.







① See page 93 for the details of the BAM alerts that the CAM system may apply for responsibility transfer.

Category	Priority	Event	Popup screen
<b>B</b>	Warning	<ul style="list-style-type: none"> <li>• A Distress call is received.</li> <li>• A DSC call whose category is “Urgency” is received.</li> </ul>	See “DSC OPERATION.” (p. 22)
	Caution	A DSC call is received that is other than a Distress call, or a DSC call whose category is “Urgency.”	See “DSC OPERATION.” (p. 22)
	Caution	The position data is invalid.	 Position data is not updating. Enter your position and time.
	Caution	<ul style="list-style-type: none"> <li>• 4 hours have passed after the position data was invalid, or after you manually entered the position and time.</li> <li>• 23.5 hours have passed after the position data was invalid, or after you manually entered the position and time.</li> </ul>	 4 hrs have elapsed since you entered position. Enter your position and time.
			 23.5 hrs have elapsed since you entered position. Enter your position and time.
Caution	The DSC task is full. (The transceiver holds 7 tasks.)	 Task memory is full. Delete unnecessary tasks.	



## ◇ Icon and Status

The icon varies, depending on the alert's priority and status, as shown below.

Priority	Icon	Status	Description	Audible signal
Warning		Active – Unacknowledged	Alert condition is still present. Alert not acknowledged.	Yes
		Active – Silenced	Alert condition is still present. Alert not acknowledged but audible signals have been silenced by the operator.	No
		Active – Acknowledged	Alert condition is still present. Alert acknowledged by the operator.	
		Active – Responsibility Transferred	Alert condition is still present. A function of the BAM compliant equipment with additional system knowledge has taken over.	
		Rectified – Unacknowledged	Alert condition rectified. Alert still unacknowledged.	
	None	Normal	No alert condition is present.	
Caution		Active	Alert condition is present.	No
	None	Normal	No alert condition is present.	

## ◇ BAM List

The BAM List screen displays the received alerts. When the alert status changes to “Normal,” the alert disappears from the list.

The alerts are sorted by priority, and the highest priority alert is located at the top of the list. When there are alerts with the same priority, the newest alert is displayed at the top of the list.

**NOTE:** When the BAM function is turned OFF, the BAM List is not displayed on the Menu screen. (pp. 69, 72)

1. Push [MENU].
2. Select “BAM List,” and then push [ENT].

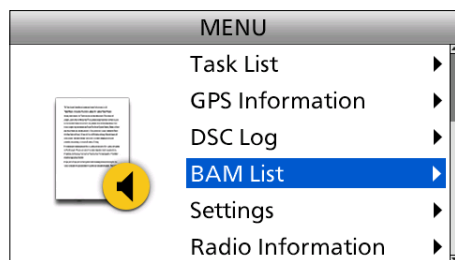

**TIP:** You can also enter the BAM List screen by holding down [CH/ENT] for 1 second on the Main screen.

3. Select an alert.
  - The alert whose status is “Active – Responsibility Transferred” is not displayed by default.
4. Push the Software Key for your next operation.
  - ① See the next page for details.

### BAM List screen

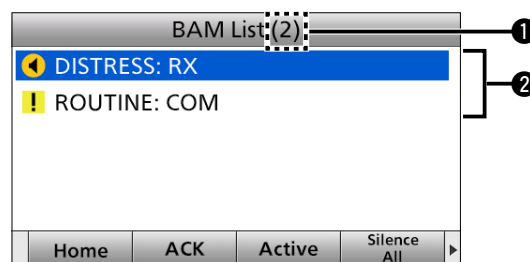

- ① **THE NUMBER OF ALERTS**  
Displays the number of the received alerts.
- ② **ALERTS INFORMATION**  
Displays the icon and title of the alert.

### About the details screen

The details screen displays the selected alert's title, description, priority, and category.

■ Bridge Alert Management (BAM)

◇ **Software Key functions**

When entering the BAM List screen, the following functions are displayed.

Function	Description
Home	Push to return to the Main screen.
ACK	Push to confirm an alert. • When an unrelated alert is selected, the key is disabled, and an error beep sounds.
Active	Push to activate the received call. • When an unrelated alert is selected, the key is disabled, and an error beep sounds.
Silence All	Push to mute for 30 seconds, all alerts that the transceiver has received. • The key is disabled, and an error beep sounds when: - There are no related alerts. - The alerts are already muted.
Top	Push to return to the first page and select the alert that has the highest priority.
Exit	Push to return to the Main screen.
Back	Push to return to the Menu screen.
Details	Push to display the details of the selected alert.
Show RESP transferred (Show responsibility transferred)	Push to display the alert that the status is "Active – Responsibility Transferred." • Displayed only when the alert that the status is "Active – Responsibility Transferred" is not displayed.
Hide RESP transferred (Hide responsibility transferred)	Push to hide the alert that the status is "Active – Responsibility Transferred." • Displayed only when the alert that the status is "Active – Responsibility Transferred" is displayed.

When entering the details screen of the selected alert by pushing [Details], the following functions are displayed.

Function	Description
Home	Push to return to the Main screen.
ACK	Push to confirm an alert. • Displayed only when the priority of the selected alert is "Warning."
Active	Push to activate the received call. • Displayed only when the selected alert is related to receiving a DSC call.

## About DSC

Digital Selective Calling (DSC) is an automated digital communication system defined by ITU-R M.493, and is also part of the Global Maritime Distress and Safety System (GMDSS). The international VHF and MF/HF marine transceivers installed in this system can transmit and receive Distress, Urgency, Safety, and Routine DSC calls to and from other vessels and coast stations. If your vessel requires assistance, contact other vessels and the Coast Guard by sending a Distress call, which includes your MMSI code, the position and time data, and the nature of distress on an emergency frequency.

### NOTE:

- To use a DSC call, entering the MMSI code is needed. See page 8 for details.
- To send your vessel's position and time data, receiving them from the GPS antenna or manually entering is needed. See page 75 for connector connection and page 24 for manual input details.
- The Mode setting of all DSC call is fixed to "Telephony."
- The order of priority for DSC calls is Distress, Urgency, Safety, and Routine.

## DSC address ID

### ◇ Entering an Individual ID and Group ID

You can enter a total of 75 Individual IDs and 25 Group IDs, and assign names of up to 10 characters.

(Example: Entering an Individual ID)

1. Open "Individual ID."

[MENU] > Settings > DSC > **Individual ID**

- "No ID" is displayed if no ID is entered.
- ① To entering a Group ID:

[MENU] > Settings > DSC > **Group ID**

2. Push [Add] .
  - The ID entry screen is displayed.

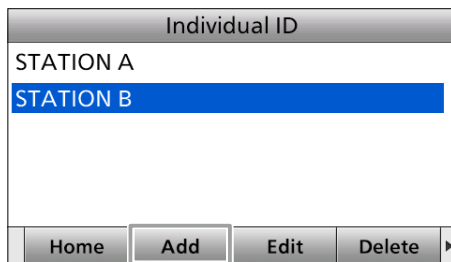

3. Select "Address."

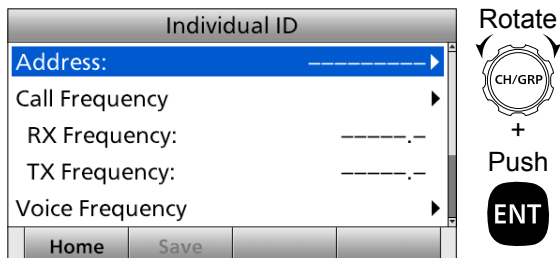

4. Enter a 9 digit Individual or Group ID. After entering, select "Finish" and push [ENT].



### NOTE:

- For a Group ID, the first digit is fixed as "0."
- For any coast station ID, the first two digits are fixed as "00."

5. Select "Call Frequency."

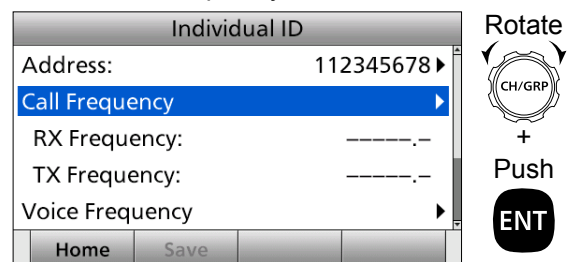

6. Enter an RX frequency. After entering, select "Next" and push [ENT].

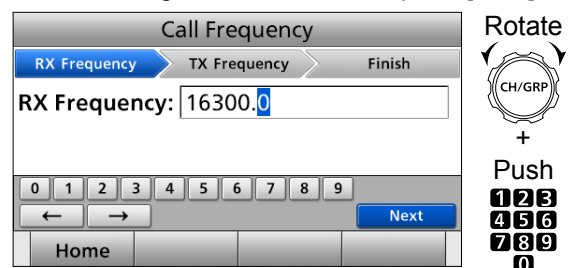

► Continued on the next page.

# 6 DSC OPERATION

## ■ DSC address ID

7. Enter a TX frequency.  
After entering, select “Finish” and push [ENT].

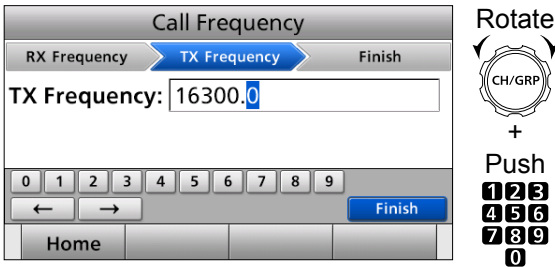

12. Enter an Individual ID name.  
After entering, select “Finish” and push [ENT].



8. Select “Voice Frequency.”

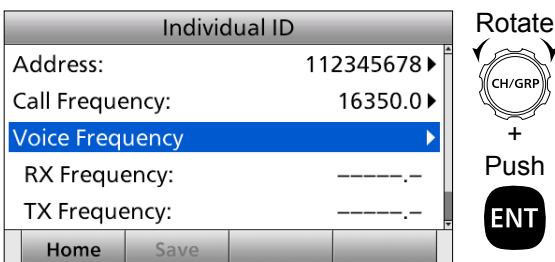

13. Push [Save] .  
• “Are you sure?” is displayed.

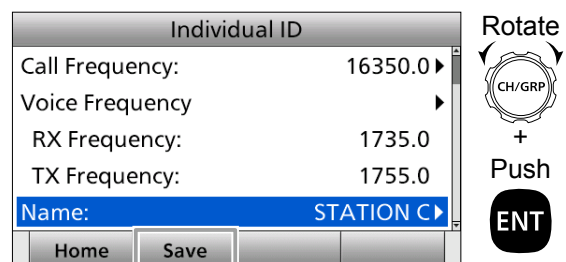

9. Enter an RX frequency.  
After entering, select “Next” and push [ENT].

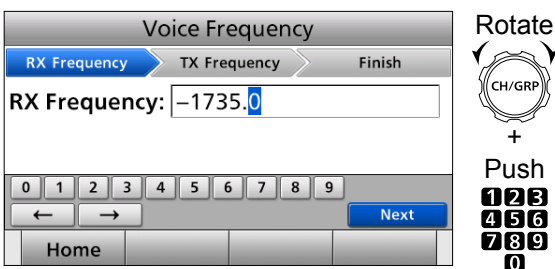

14. Push [OK]  to save the ID.  
• The entered name is displayed.

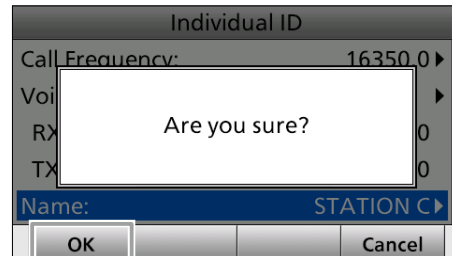

10. Enter a TX frequency.  
After entering, select “Finish” and push [ENT].

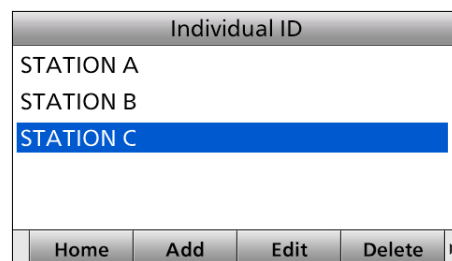
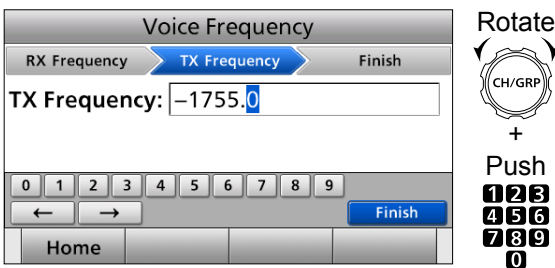

11. Select “Name.”

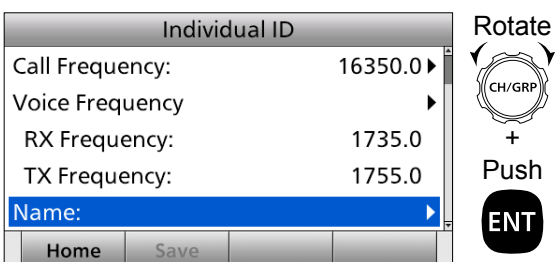

15. Push [MENU] to return to the Main screen.

**TIP:** You can edit the settings of the selected ID by pushing [Edit]  in step 2.

### ◇ Deleting an entered ID

(Example: Deleting a Group ID: GROUP 2)

1. Open "Group ID."

[MENU] > Settings > DSC > **Group ID**

2. Select the "GROUP 2," and then Push [Delete] .
  - "Delete the ID. Are you sure?" is displayed.

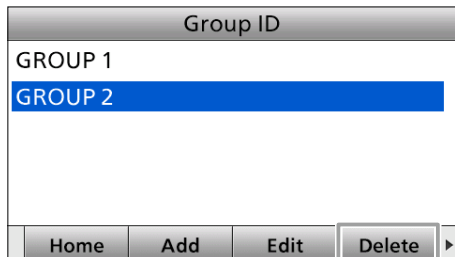

3. Push [OK] .
  - The selected ID is deleted, and then returns to the previous screen.

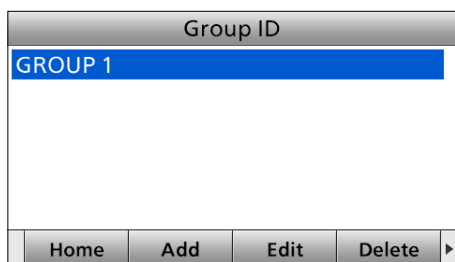

① Push [Cancel]  to cancel the deletion.

## ■ Entering position data and time

A Distress call should include the vessel's position data and time. If a GPS receiver compatible with the IEC 61162-1 Ed.5 (2016-08) format is connected, position and UTC time are automatically received. If no GPS data is being received, manually enter your position and Universal Time Coordinated (UTC).

### NOTE:

- Manual entry is disabled while valid GPS data is being received.
- The Manually entered position and time are valid only for 23.5 hours.

1. Open "Position Input."

[MENU] > Settings > DSC > **Position Input**

2. Enter the latitude.
  - After entering, select "Next" and push [ENT].

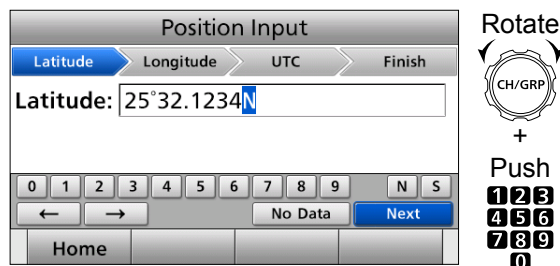

① To select 'N' (North latitude) or 'S' (South latitude), select "N" or "S" on the screen and push [ENT], or push a Keypad key when the cursor is on the 'N' or 'S.'

3. Enter your longitude.
  - After entering, select "Next" and push [ENT].

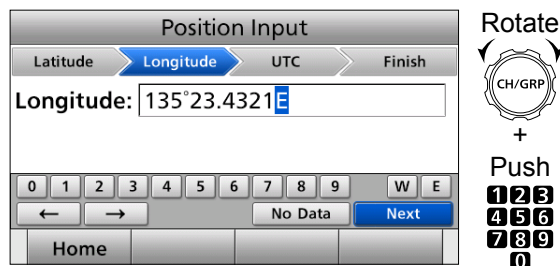

① To select 'W' (West longitude) or 'E' (East longitude), select "W" or "E" on the screen and push [ENT], or push a Keypad key when the cursor is on the 'W' or 'E.'

4. Enter the UTC.
  - After entering, select "Finish" and push [ENT].
  - After [ENT] is pushed, the entered position data and time is set, and the DSC Settings screen is displayed.

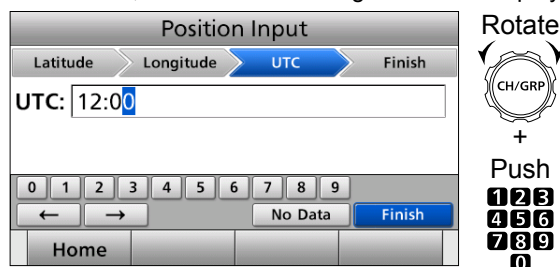

5. Push [MENU] or [Home]  to return to the Main screen.

## ■ DSC Task mode



The transceiver can hold up to 7 tasks. You can handle more than 2 DSC tasks simultaneously by switching between the tasks.

**NOTE:** The Task mode has the Time-out Timer (TOT) function. After a certain period of time has passed without any operation on a task, the transceiver automatically deletes a task and returns to the Main screen. When the TOT function is activated, an alarm sounds, and a countdown message is displayed for 10 seconds.

In the Task mode, you can hold or activate the DSC task as follows.



### Example (When a Group call is received):

#### ◇ Holding a DSC task

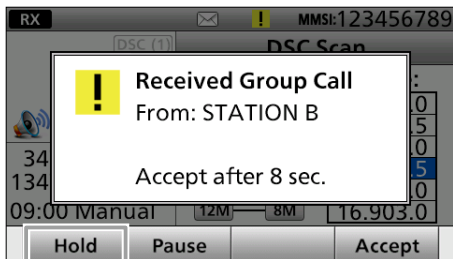
1. Push [Close]  to turn OFF the alarm.
  - When the BAM function (p. 18) is OFF: Push [Alarm Off] .
  - The received call's information is displayed.
2. Push [Hold] .
  - The received Group call task is held into the Task List, and returns to the operating screen.



#### ◇ Activating the held DSC task

1. Push [Task List]  to display the Task List.
  - The Task List is displayed.
2. Select the task that you want to activate.
3. Push [Active]  to activate the task.

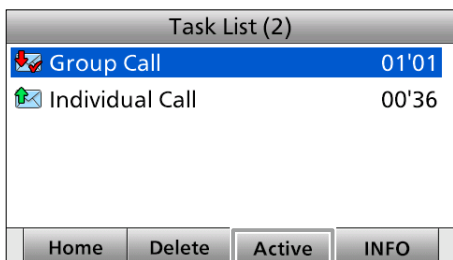

- The activated task information is displayed.

4. Push [PTT] to communicate.

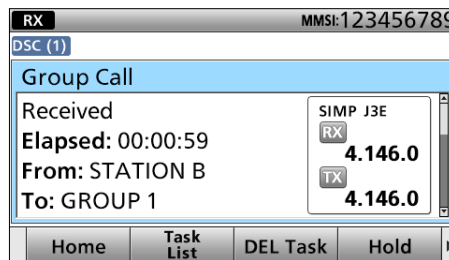

5. After finishing the communication, push [DEL Task]  to delete the task.

#### ◇ Task List

You can display the Task List screen by pushing [Task List] . The number of tasks is displayed at the top of the screen.

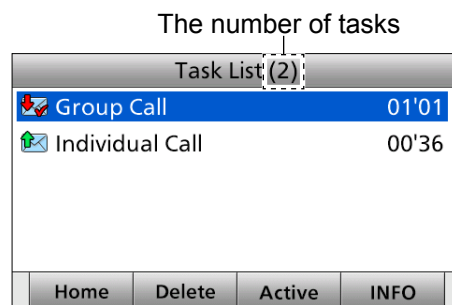

On the Task List screen, the following Software keys are displayed.

FUNCTION	DESCRIPTION
Home	Push to hold the task and return to the Main screen.
Delete	Push to delete the selected task.
Hold	Push to hold the selected task.
Active	Push to activate the selected task.
INFO	Push to display the task information. <ul style="list-style-type: none"> <li>• Displayed only when a DSC task is selected.</li> </ul>

## ■ Sending DSC calls (Distress)

**NEVER MAKE A DISTRESS CALL IF YOUR VESSEL OR A PERSON IS NOT IN AN EMERGENCY.  
A DISTRESS CALL SHOULD BE MADE ONLY WHEN IMMEDIATE HELP IS NEEDED.**

A Distress call should be sent when, in the opinion of the captain, the vessel or a person is in distress and requires immediate assistance.

### ◇ Simple call

1. Confirm no Distress call is being received.
2. While lifting the key cover, hold down [DISTRESS] for 3 seconds until you hear 3 short countdown beeps and 1 long beep sound.

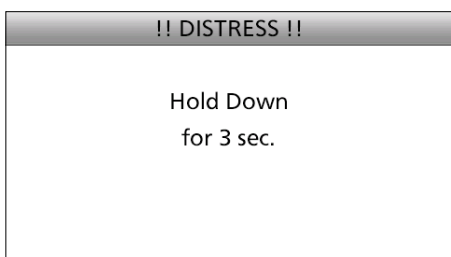

- The backlight blinks.
  - ① All Emergency Frequencies are automatically selected to send a Distress call.
3. After sending, wait for an Acknowledgment call.

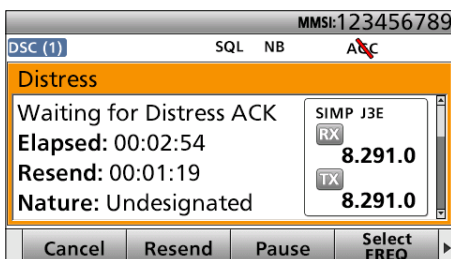

- "Waiting for Distress ACK" is displayed.
- The Distress call is automatically sent every 3.5 to 4.5 minutes until an Acknowledgment is received, or a Distress Cancel call is sent.

See NOTE on page 28 for a Distress call.

4. When receiving the acknowledgment:
  - Alarm sounds.
  - The following screen is displayed.
  - The backlight blinks when the BAM function (p. 18) is OFF.

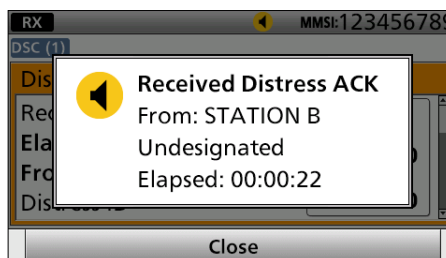

5. Push [Close] .
  - ① When the BAM function (p. 18) is OFF: Push [Alarm Off] , and then push [Close Call RCVD Window] .
6. Hold down [PTT], and then explain your situation.
7. After you have finished your explanation, push [Home] to return to the Main screen.

**NOTE:** A default Distress alert contains:

- Nature of distress: Undesignated distress.
- Position data: The latest GPS or manual input position held for 23.5 hours or until you turn OFF the transceiver.

■ Sending DSC calls (Distress)

◇ Regular call

Select the nature of the Distress call to include in the Regular Distress call.

1. Push [Compose Distress] .
  - The “Compose Distress” screen is displayed.
  - ① To display the screen from the Menu screen:

[MENU] > **Compose Distress**

**Step.1 Setting “Nature of Distress”**

1. Select “Nature of Distress.”

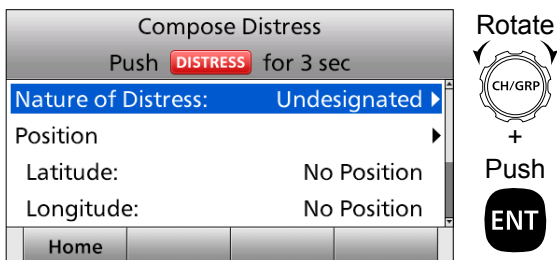

2. Select the nature of the Distress. (Example: Fire, Explosion)
  - The setting is saved and returns to the previous screen.
  - ① The transceiver saves this setting for 30 seconds.

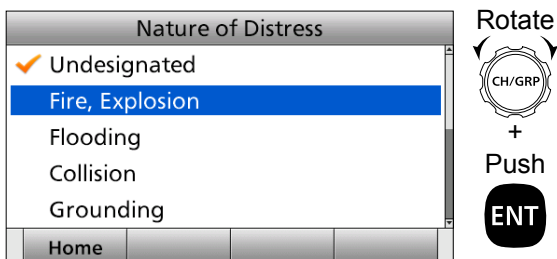

**Step 2. Entering “Position”**

**NOTE:** When your position data and time are valid, you can skip this step and go to step 3.

1. Select “Position.”

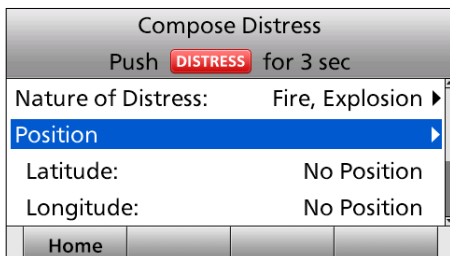

2. Enter your position data and time.
  - See page 24 for entering details.

**Step 3. Setting communication frequency**

1. Select “Attempt.”

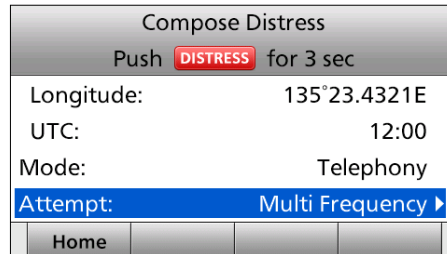

2. Select an option. (Example: Multi Frequency)
  - The setting is saved and returns to the previous screen.

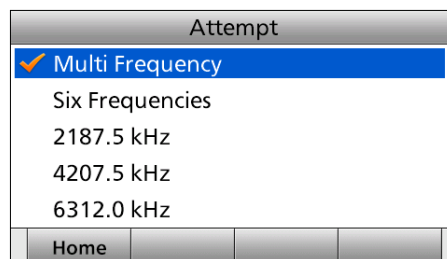

**Step 4. Sending**

1. While lifting the key cover, hold down [DISTRESS] for 3 seconds until you hear 3 short countdown beeps and 1 long beep sound.
  - The backlight blinks.

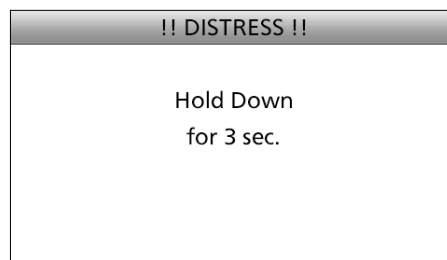

**NOTE:** To cancel a Distress call while transmitting, see page 29.

2. After sending, wait for an Acknowledgment call.
  - “Waiting for Distress ACK” is displayed.
  - The Distress call is automatically sent every 3.5 to 4.5 minutes until an Acknowledgment is received, or a Distress Cancel call is sent.

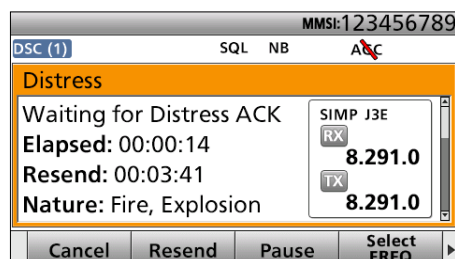



### Step. 5 Replying

- When receiving the Acknowledgment:
  - Alarm sounds.
  - The following screen is displayed.
  - The backlight blinks when the BAM function (p. 18) is OFF.

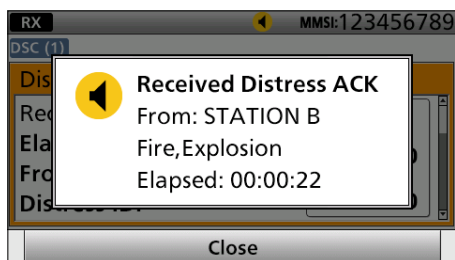

- Push [Close] .
  - ① When the BAM function (p. 18) is OFF: Push [Alarm Off] , and then push [Close Call RCVD Window] .
- Hold down [PTT], and then explain your situation.
- After you have finished your explanation, push [Home] to return to the Main screen.

**NOTE:**

**Transmitting:**

- A Distress call default contains:
  - Nature of distress: Undesignated distress (Simple Call) Selected in Step 1 (Regular call)
  - Position data: The latest GPS or manual input position data is retained for 23.5 hours, unless you turn OFF the transceiver.
- While holding down [DISTRESS], count down beeps sound, and both the key and display backlights blink.
- All Emergency Frequencies are automatically selected to send a Distress call. You can select one or more Emergency Frequencies to send a Regular Distress call.

**Waiting for an Acknowledgment:**

- The Distress call is automatically transmitted every 3.5 to 4.5 minutes, until receiving an acknowledgment ('Call repeat' mode), or sending a DSC Cancel call. (p. 29)
- To pause the 'Call repeat' mode: Push [Pause] . To resume it: Push [Resume Countdown] .
- To manually send a Distress Repeat call: Push [Resend] .
- To view the call contents: Rotate [CH/GRP], or push [▲] or [▼].

### ◇ Resending a Distress call

While waiting for an acknowledgment, you can resend the call (Repeat call).

- When "Waiting for Distress ACK" is displayed, push [Resend] .
  - The "Resend Distress" screen is displayed.

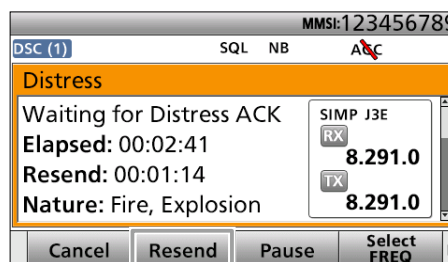

- See page 25 for details of the Software Key functions in the DSC Task mode.
- While lifting the key cover, hold down [DISTRESS] for 3 seconds until you hear 3 short countdown beeps and 1 long beep sound.
  - The backlight blinks.

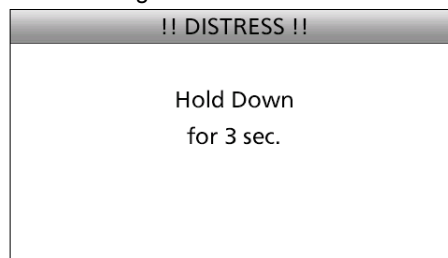

**NOTE:** To cancel a Distress call while transmitting, see page 29.

- When receiving the Acknowledgment:
  - Alarm sounds.
  - The following screen is displayed.
  - The backlight blinks when the BAM function (p. 18) is OFF.

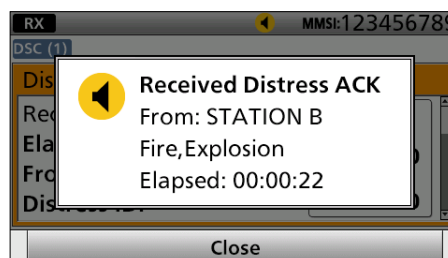

- Push [Close] .
  - ① When the BAM function (p. 18) is OFF: Push [Alarm Off] , and then push [Close Call RCVD Window] .
- Hold down [PTT], and then explain your situation.
- After you have finished your explanation, push [Home] to return to the Main screen.

■ Sending DSC calls (Distress)

◇ Sending a Distress Cancel call

If you have accidentally made a Distress call, or made an incorrect Distress call, send a Distress Cancel call to cancel the call as soon as possible while waiting for an Acknowledgment. **BE SURE** to report the purpose of the cancellation.

**While transmitting a Distress call:**

1. While transmitting a Distress call, push [Cancel] .



2. Confirm the content and push [OK] .
  - ① The frequencies that you have to send voice cancel messages are displayed. (Example: 2/4/8/12/16 MHz)

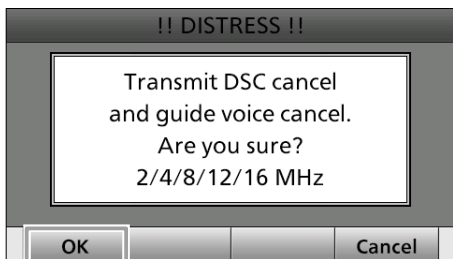

- ① To cancel the Distress Cancel call, push [Cancel] .



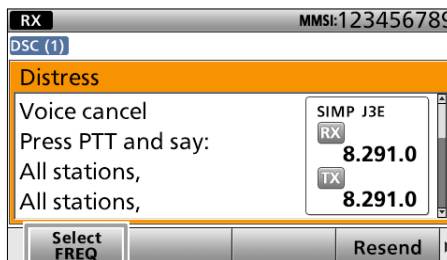

3. After sending, the following screen is displayed. Push [Select FREQ] .

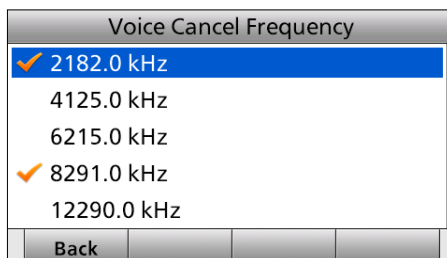

4. Select a frequency to send a voice cancel message.
  - ① The check mark shows that the Distress call on the selected frequency is canceled by sending voice cancel message.



5. Hold down [PTT] to report the purpose of the cancellation.
  - ① You can confirm the statement of the Distress Cancel call by rotating [CH/GRP].
6. Repeat steps 3 to 5 to cancel for all frequencies.
7. After sending a voice cancel message on all frequencies, [Finish]  is displayed. Push [Finish] .

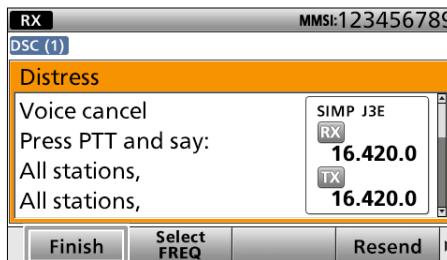

8. Push [Home]  to return to the Main screen.

**While waiting for a Distress Acknowledgment:**

1. When “Waiting for Distress ACK” is displayed, push [Cancel] .

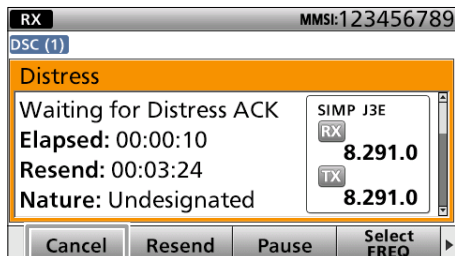

① See page 25 for details of the Software Key functions in the DSC Task mode.

2. Push [OK]  to send the Distress Cancel call.

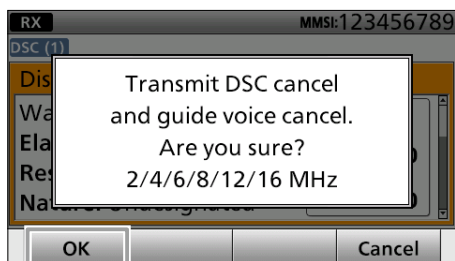

① The frequencies that you have to send voice cancel messages are displayed. (Example: 2/4/6/8/12/16 MHz)

① To cancel the Distress Cancel call, push [Cancel] .



3. After sending, the following screen is displayed. Push [Select FREQ] .

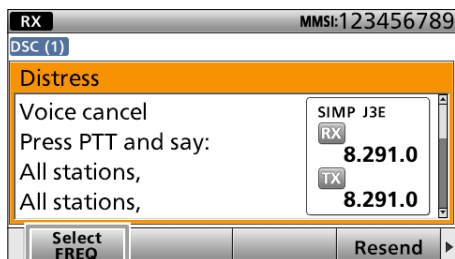

4. Select a frequency to send a voice cancel message and push [ENT].

① The check mark shows that the Distress call on the selected frequency is canceled by sending voice cancel message.

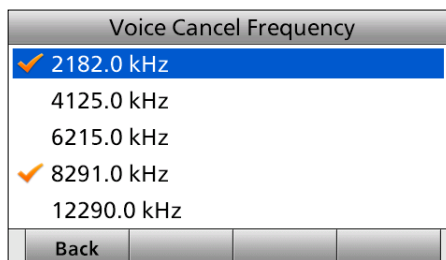

5. Hold down [PTT] to report the purpose of the cancellation.
 

① You can confirm the statement of the Distress Cancel call by rotating [CH/GRP].
6. Repeat steps 3 to 5 to cancel for all frequencies.
7. After sending a voice cancel message on all frequencies, [Finish]  is displayed.

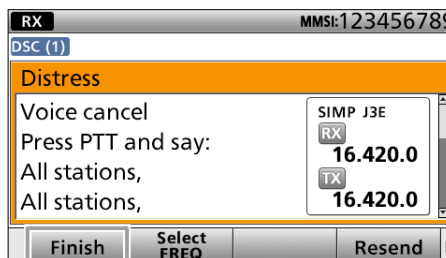

8. Push [Home]  to return to the Main screen.

■ Sending DSC calls (Distress)

◇ Sending a Distress Acknowledgment

Distress call reception should stop after one sequence because the coast station should send back an 'Acknowledgment' to the vessel. If the Distress call continues even the coast station send back an 'Acknowledgment,' the vessel in distress may not be receiving the call. In such cases, you should contact the coast station via the phone and send back an 'Acknowledgment' on behalf of the coast station if the coast station requires.

**IMPORTANT:** Distress Acknowledgments should be transmitted only on the 2187.5 kHz, according to regulations (ITU-R 493-13). When you receive a Distress call on other frequency bands, [ACK (Distress)] is not displayed in the Software Key area.

**Quick ACK:**

- When a Distress call is received:
  - Alarm sounds.
  - The following screen is displayed.
  - The backlight blinks when the BAM function (p. 18) is OFF.

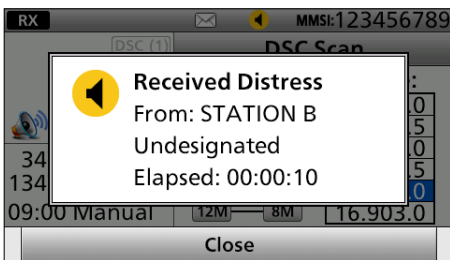

- Push [Close] .
  - Ⓜ When the BAM function (p. 18) is OFF: Push [Alarm Off] .

- Push [Accept] .

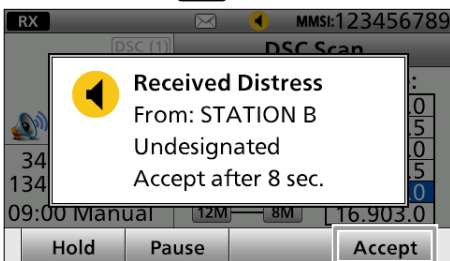

• Enters the DSC Task mode.

- Push [▶] to scroll the software key functions.
- Push [ACK (Distress)] .

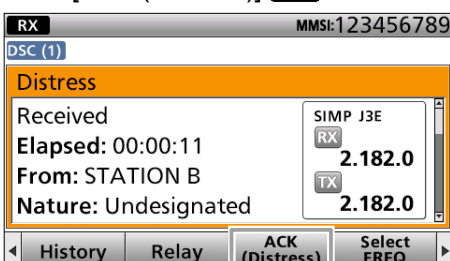

- Push [OK] .

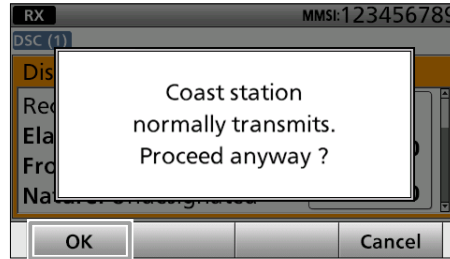

• The DSC call contents screen is displayed.  
 Ⓜ Rotate [CH/ENT] to view the call contents.

- Push [Call] to send a Distress acknowledgment.

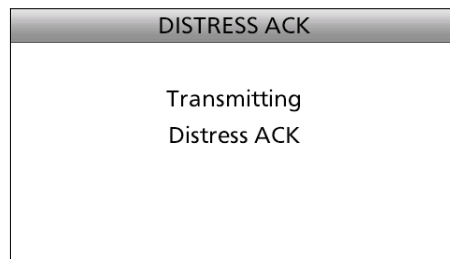
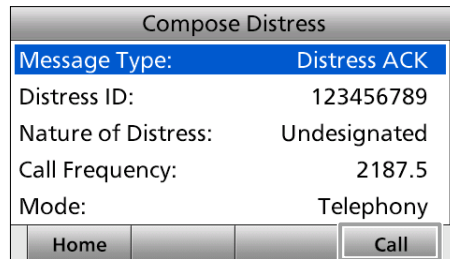

- After sending, the following screen is displayed.

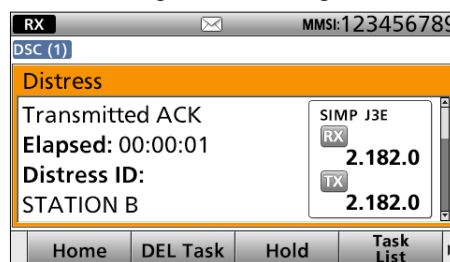

- Hold down [PTT] to communicate with the vessel in distress.
- Push [Home] to return to the Main screen.

**TIP:** When you push [Pause] in step 3, the countdown will be paused. Push [Resume Countdown] to restart the countdown.

### ◇ Sending a Distress Relay call

There are 2 ways to transmit the distress relay call—“Distress Relay On Behalf Of Someone Else (DROBOSE)” and “Distress Relay Call with Distress Call Log.”

**NOTE: DO NOT** push [DISTRESS] to transmit a distress relay call. It is used for only your own distress calls.

#### To transmit the Distress Relay call with “DROBOSE”:

You may transmit a Distress Relay call when a vessel in distress is in a situation where the Distress call cannot be transmitted, or when you find a vessel in distress and quick help is needed.

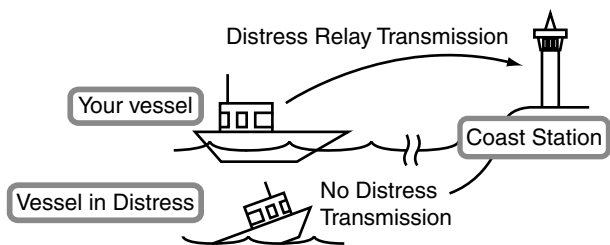

1. Push [Compose DROBOSE] .
  - The “Compose DROBOSE” screen is displayed.

① To display the screen from the Menu screen:

[MENU] > **Compose DROBOSE**

2. Select “Message Type.”

3. Select a message type. (Example: Individual)

4. Select “Address.”

5. Select a coast station address or “Manual Input.” (Example: COAST A)

**NOTE:** When you select “Manual Input” in this step, push the keypad to manually enter an Individual ID.

6. Select “Distress ID.”

7. Select “Manual Input.”

**NOTE:** Distress Call Log is displayed after receiving the Distress call. **DO NOT** select displayed Individual IDs for DROBOSE.

► Continued on the next page.

■ Sending DSC calls (Distress)

◇ Sending a Distress Relay call (continued)

8. Enter the Distress ID (MMSI ID) code of the vessel in distress that you want to help. After entering, select “Finish” and push [ENT].

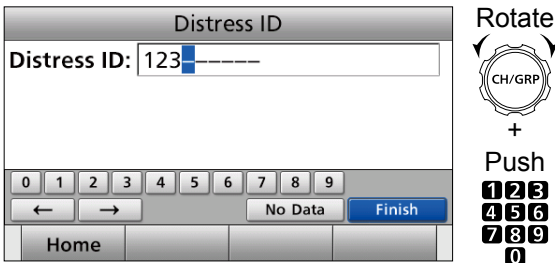

9. Select “Nature of Distress.”

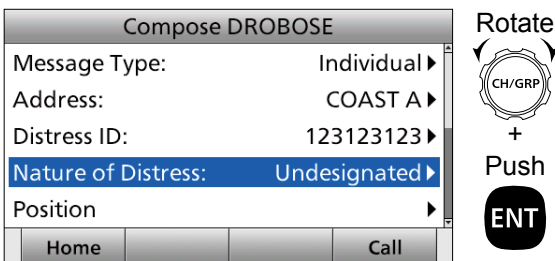

10. Select an option. (Example: Fire, Explosion)  
 ① The transceiver stores this setting for 30 seconds.

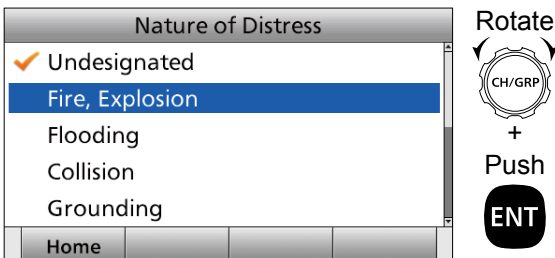

11. Select “Position.”

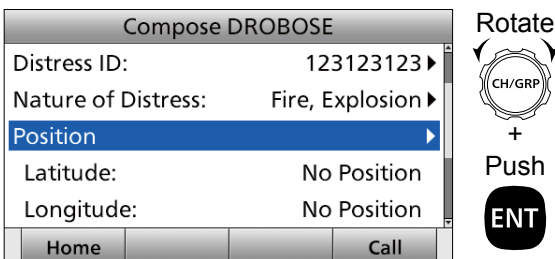

- The Latitude Position Entry screen is displayed.
- Your position data and time are displayed.

12. Enter the position data and time of the vessel in distress. After entering, select “Finish” and push [ENT].  
 ① See page 24 for position entering details.

13. Select “Call Frequency.”

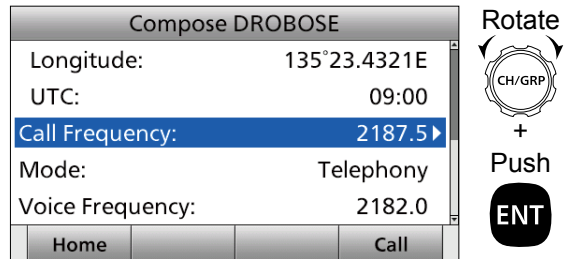

14. Select an option. (Example: 2187.5 kHz)

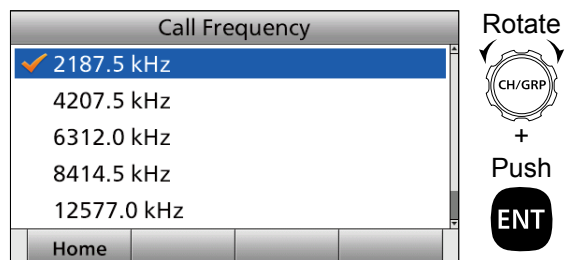

15. Push [Call] to send the Distress Relay call.

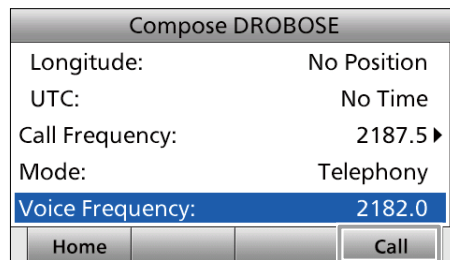

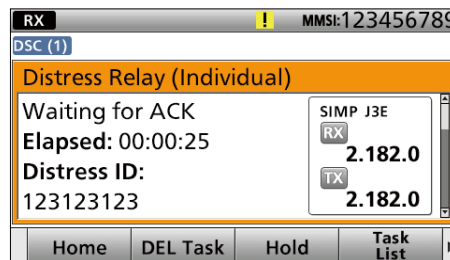

16. After sending, the following screen is displayed.





① See page 25 for details of the software key function in the DSC Task mode.

17. When receiving the acknowledgment:
  - Alarm sounds.
  - The following screen is displayed.

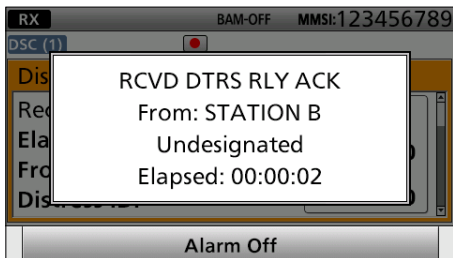

- When the BAM function (p. 18) is OFF: The backlight blinks and the popup screen is displayed. Push [Alarm Off] , and then push [Close Call RCVD Window] .



18. Hold down [PTT] to communicate with a maritime station.
19. Push [Home]  to return to the Main screen.

**To transmit the Distress Relay call with “Distress Call Log”:**

You can relay a distress call after receiving the distress call.

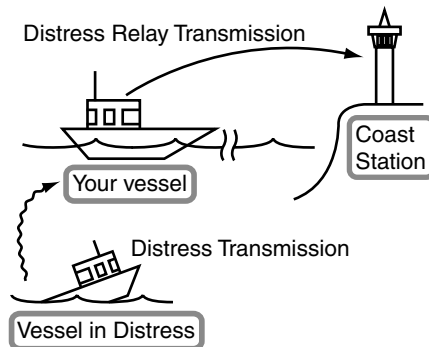

1. Push [Compose DROBOSE] .
  - The “Compose DROBOSE” screen is displayed.
  - ⓘ To display the screen from the Menu screen:

[MENU] > **Compose DROBOSE**

2. Select “Message Type.”

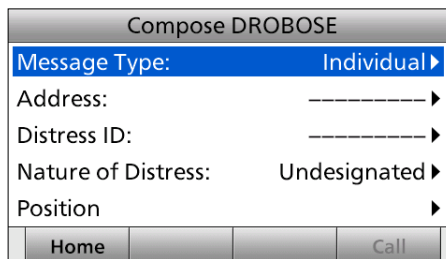

3. Select a message type. (Example: Individual)

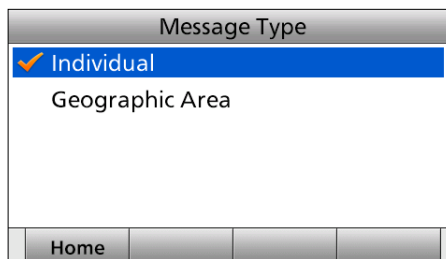

4. Select “Address.”

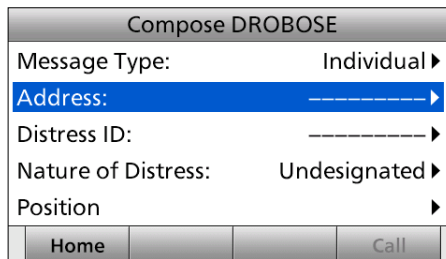

► Continued on the next page.

■ Sending DSC calls (Distress)

◇ Sending a Distress Relay call (continued)

5. Select a coast station address or "Manual Input." (Example: COAST A)

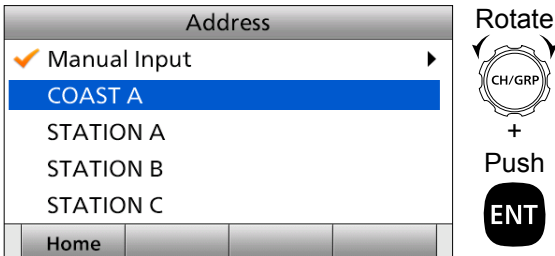

**NOTE:** When you select "Manual Input" in this step, push the keypad to manually enter an Individual ID.

6. Select "Distress ID."

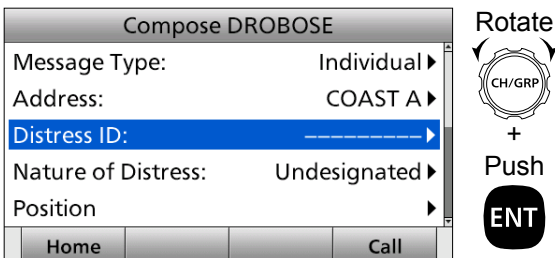

7. Select a Distress ID from the list.

① Distress Call Log is displayed after receiving the Distress Call.

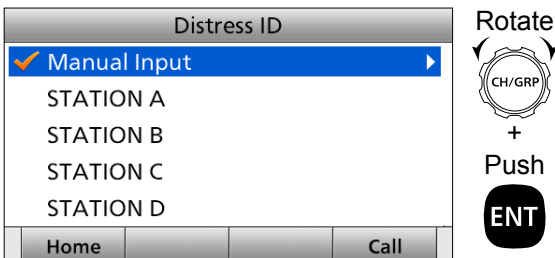

8. Select "Call Frequency."

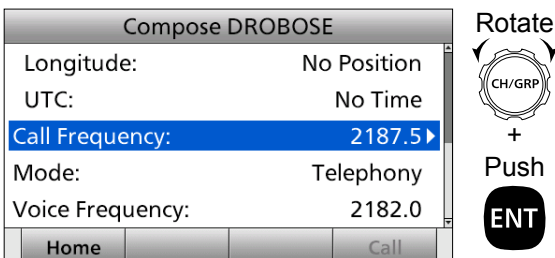

9. Select an option. (Example: 2187.5 kHz)

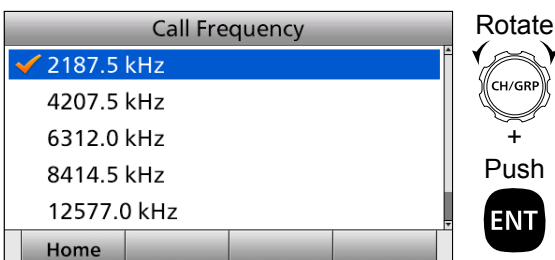

10. Push [Call] to send the Distress Relay call.

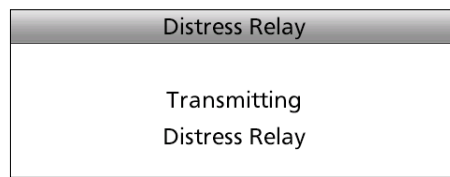
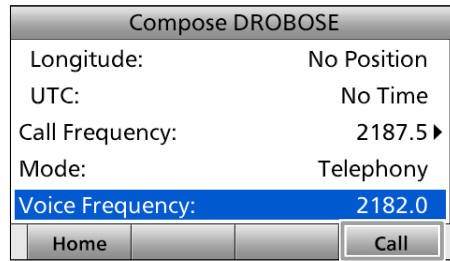

11. After sending, the following screen is displayed.

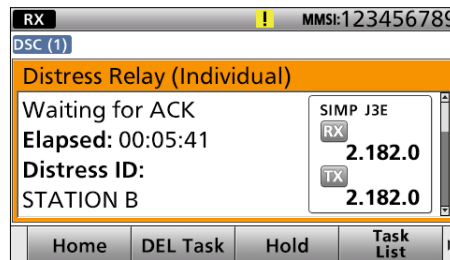

① See page 25 for details of the software key function in the DSC Task mode.

12. When receiving the Acknowledgment:

- Alarm sounds.
- The following screen is displayed.

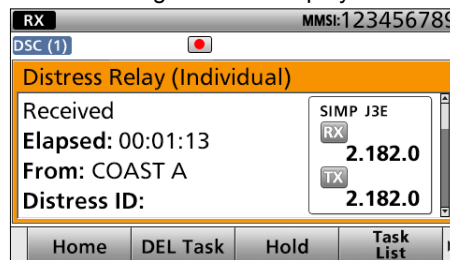

- When the BAM function (p. 18) is OFF: The backlight blinks and the popup screen is displayed. Push [Alarm Off], and then push [Close Call RCVD Window].



13. Hold down [PTT] to communicate with a coast station.

14. Push [Home] to return to the Main screen.



### ◇ Sending a Distress Relay Acknowledgment

Only when the Distress Relay call is received, you can send the Distress Relay Acknowledgment.

#### Quick ACK:

- When a Distress Relay call is received:
  - Alarm sounds.
  - The following screen is displayed.
  - The backlight blinks when the BAM function (p. 18) is OFF.

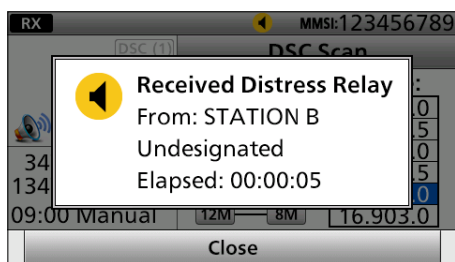

- Push [Close] .
  - ① When the BAM function (p. 18) is OFF: Push [Alarm Off] .
- Push [Accept] .
  - Enters the DSC Task mode.
  - “✓” is displayed on the Task tab.

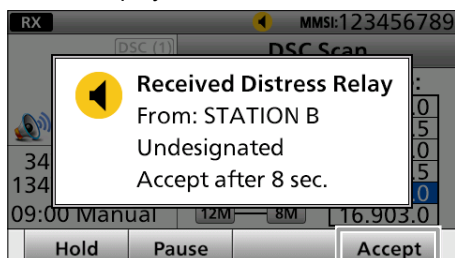

- Push [▶] to scroll the software key function.
- Push [ACK (Relay)] .
  - The call contents screen is displayed.
  - ① Rotate [CH/ENT] to view the call contents.

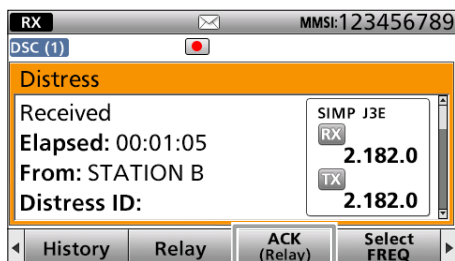

- Push [Call] to send the Distress Relay Acknowledgment.

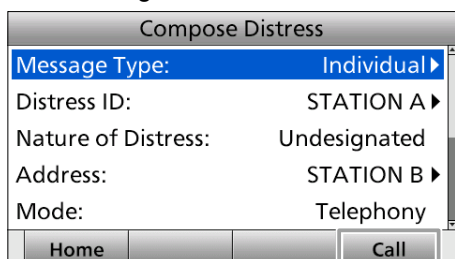

- After sending, the following screen is displayed.

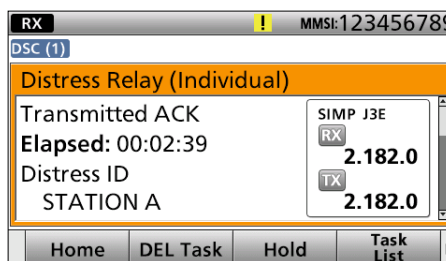

- Hold down [PTT] to communicate with the vessel in distress.
- Push [Home] to return to the Main screen.

**TIP:** When you push [Pause] in step 2, the countdown will be paused. Push [Resume Countdown] to restart the countdown.

## ■ Sending DSC calls (Other)

### ◇ Sending an Individual call

An Individual call enables you to send a DSC signal to only a specific station.

You can communicate normally after receiving the Acknowledgment “ACK (able).”

① You can send an Individual call to a pre-entered Individual ID or manually enter the target station ID before sending. (p. 22)

1. Push [Compose Other] .
  - The “Compose Non-Distress” screen is displayed.
  - ① To display the screen from the Menu screen:

[MENU] > **Compose Other**

2. Select “Address.”

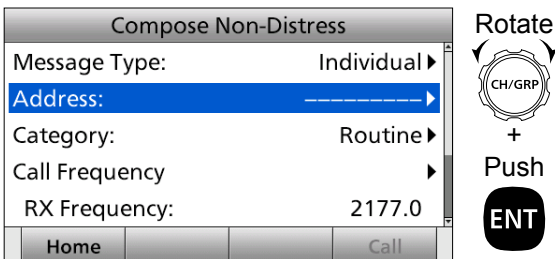

Compose Non-Distress

Message Type: Individual ▶

**Address:** ----- ▶

Category: Routine ▶

Call Frequency ▶

RX Frequency: 2177.0

Home Call

Rotate CH/GRP + Push ENT

3. Select an Individual address, or “Manual Input.” (Example: STATION B)

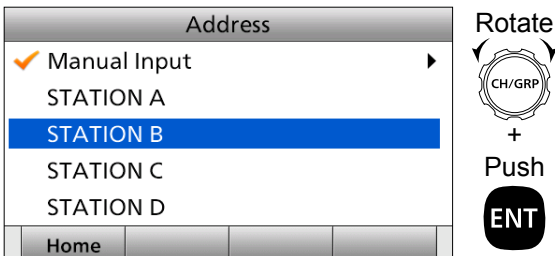

Address

✓ Manual Input ▶

STATION A

**STATION B**

STATION C

STATION D

Home

Rotate CH/GRP + Push ENT

**NOTE:** When you select “Manual Input” in this step, push the keypad to manually enter an Individual ID.

4. Select “Category.”

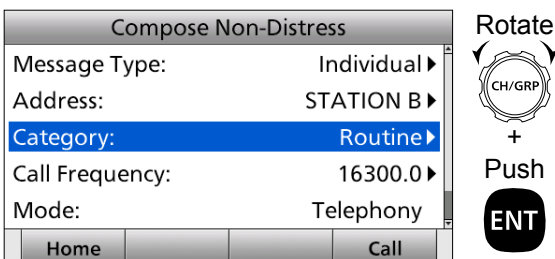

Compose Non-Distress

Message Type: Individual ▶

Address: STATION B ▶

**Category:** Routine ▶

Call Frequency: 16300.0 ▶

Mode: Telephony

Home Call

Rotate CH/GRP + Push ENT

5. Select an option. (Example: Routine)

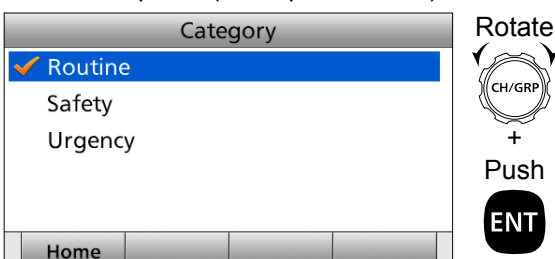

Category

✓ Routine

Safety

Urgency

Home

Rotate CH/GRP + Push ENT

6. Select “Call Frequency.”

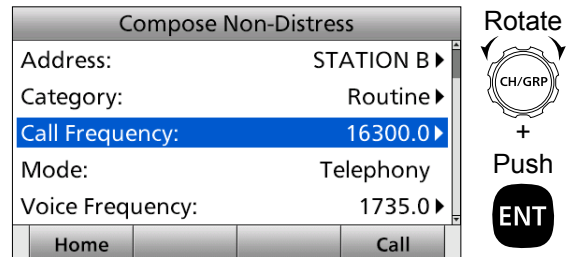

Compose Non-Distress

Address: STATION B ▶

Category: Routine ▶

**Call Frequency:** 16300.0 ▶

Mode: Telephony

Voice Frequency: 1735.0 ▶

Home Call

Rotate CH/GRP + Push ENT

7. Select a call frequency, or “Manual Input.” (Example: INTER12-1)

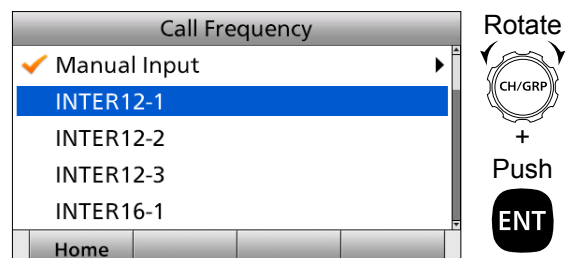

Call Frequency

✓ Manual Input ▶

**INTER12-1**

INTER12-2

INTER12-3

INTER16-1

Home

Rotate CH/GRP + Push ENT

8. Select “Voice Frequency.”

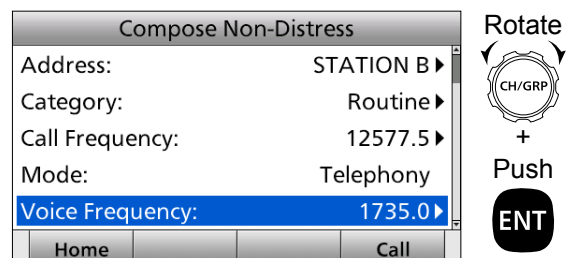

Compose Non-Distress

Address: STATION B ▶

Category: Routine ▶

Call Frequency: 12577.5 ▶

Mode: Telephony

**Voice Frequency:** 1735.0 ▶

Home Call

Rotate CH/GRP + Push ENT

9. Select a voice frequency, or “Manual Input.” (Example: CH 4-1)

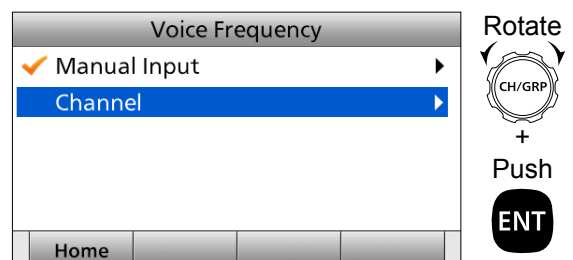

Voice Frequency

✓ Manual Input ▶

**Channel**

Home

Rotate CH/GRP + Push ENT

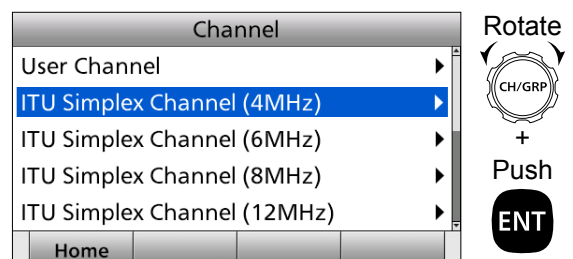

Channel

User Channel ▶

**ITU Simplex Channel (4MHz)**

ITU Simplex Channel (6MHz) ▶

ITU Simplex Channel (8MHz) ▶

ITU Simplex Channel (12MHz) ▶

Home

Rotate CH/GRP + Push ENT

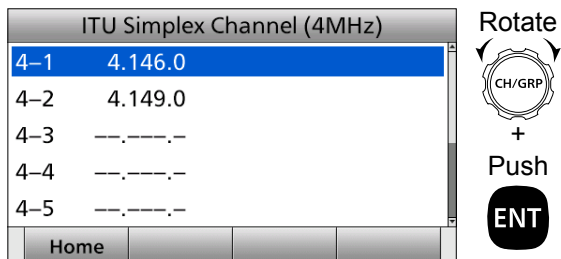

**NOTE:** When you select “Manual Input” in this step, push the keypad to manually enter a voice frequency.

10. Push [Call] to send an Individual call.
  - “Transmitting Individual Call” is displayed, and then “Waiting for ACK” is displayed.

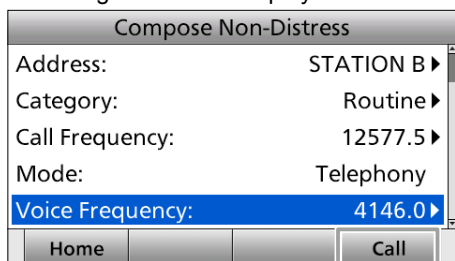

① See page 25 for details of the Software Key functions in the DSC Task mode.

11. After sending, wait for an Acknowledgment call.

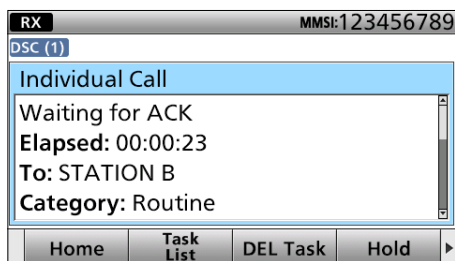

12. When receiving the Acknowledgment:
  - Alarm sounds.
  - The following screen is displayed. (Example: ACK (Able))

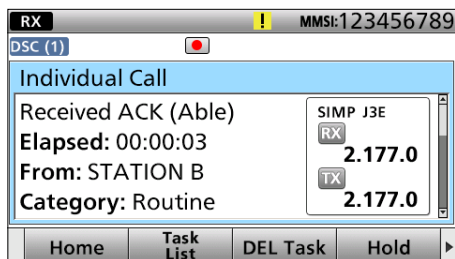

- When the BAM function (p. 18) is OFF: The backlight blinks and the popup screen is displayed. Push [Alarm Off] , and then push [Close Call RCVD Window] .

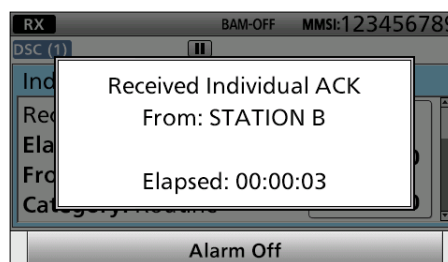

**When the BAM function is OFF.**

13. Hold down [PTT] to communicate normally.
14. Push [Home] to return to the Main screen.

**NOTE:**  
**After receiving the Acknowledgment:**

- The voice frequency specified in step 9 is selected.
- A different voice frequency is selected if the station you called cannot use the channel.

### ◇ Sending an Individual Acknowledgment

When receiving an Individual call (p. 55), you can send an Acknowledgment to the calling station. When “Manual” is selected in “Individual ACK” (p. 65), you can select an appropriate Acknowledgment type.

1. When an Individual call is received:
  - Alarm sounds.
  - The following screen is displayed.
  - The backlight blinks when the BAM function (p. 18) is OFF.

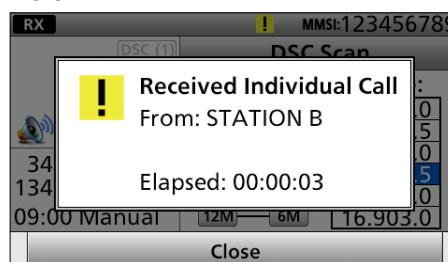

2. Push [Close] .
  - ① When the BAM function (p. 18) is OFF: Push [Alarm Off] .
3. Push [Accept] .
  - Enters the DSC Task mode.

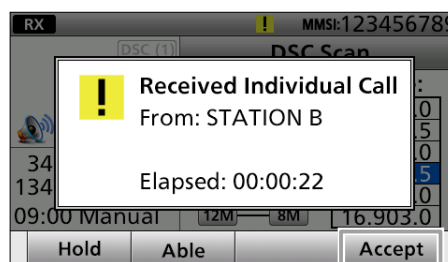

- ① If you want to immediately send an Acknowledgment “Able to comply,” push [Able] .
- ① If you want to put the task on hold, push [Hold] .

▶ Continued on the next page.

■ Sending DSC calls (Other)

◇ Sending an Individual Acknowledgment (continued)

- Select the desired action.
  - The call contents screen is displayed.

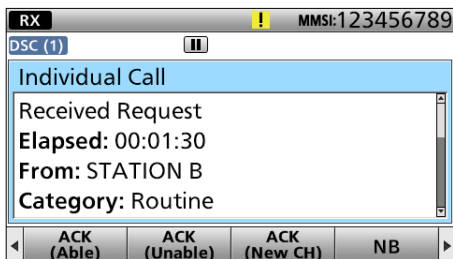

**TIPS:**  
**[ACK (Able)]** (Able to comply):  
 Send an Acknowledgment without any changes.  
**[ACK (Unable)]** (Unable to comply):  
 Send an Acknowledgment but cannot communicate.  
**[ACK (New CH)]** (Propose new channel):  
 Send an Acknowledgment. You can specify the Voice Communication channel.

- Confirm the contents.

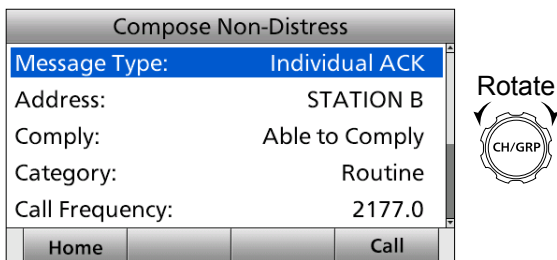

- Push [Call] to send the Individual acknowledgment.
- Hold down [PTT] to communicate normally.
- Push [Home] to return to the Main screen.

◇ Sending a Group call

A Group call enables you to send a DSC call to only a specific group.

You can send a Group call to a pre-entered Group ID or manually enter the target group before sending. (p. 22)

- Push [Compose Other] .
  - The “Compose Non-Distress” screen is displayed.
  - To display the screen from the Menu screen:

[MENU] > **Compose Other**

- Select “Message Type.”

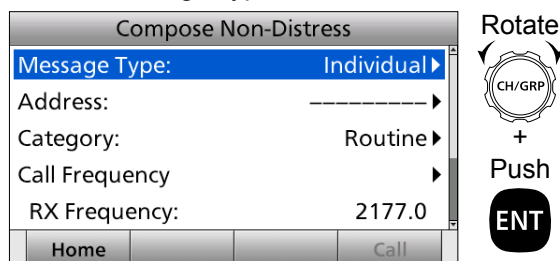

- Select “Group.”

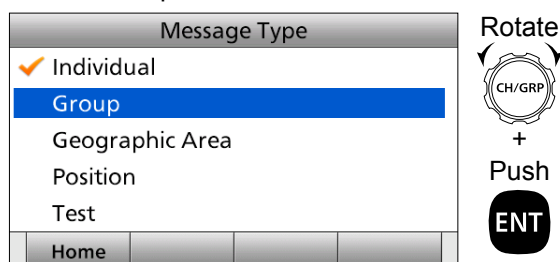

① “Category” is fixed to “Routine.”

- Select “Address.”

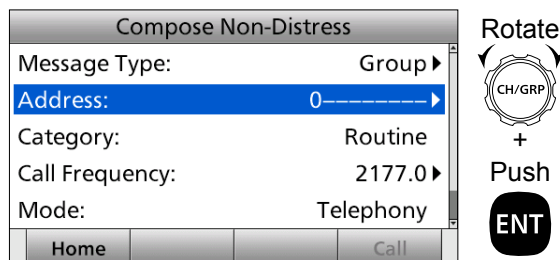

- Select a Group ID, or “Manual Input.” (Example: GROUP 1)

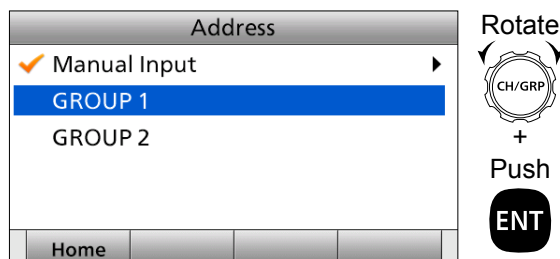

**NOTE:** When you select “Manual Input” in this step, push the keypad to manually enter a Group ID.

6. Select "Call Frequency."

Compose Non-Distress

Message Type: Group ▶

Address: GROUP 1 ▶

Category: Routine

Call Frequency: 16300.0 ▶

Mode: Telephony

Home Call

Rotate CH/GRP + Push ENT

ITU Simplex Channel (4MHz)

4-1 4.146.0

4-2 4.149.0

4-3 ---.---.-

4-4 ---.---.-

4-5 ---.---.-

Home

Rotate CH/GRP + Push ENT

**NOTE:** When you select "Manual Input" in this step, push the keypad to manually enter a communication frequency.

7. Select a call frequency, or "Manual Input." (Example: INTER12-1)

Call Frequency

Manual Input

INTER12-1

INTER12-2

INTER12-3

INTER16-1

Home

Rotate CH/GRP + Push ENT

10. Push [Call] to send the Group call.  
 • "Transmitting Group Call" is displayed, and then "Group Call" is displayed.

Compose Non-Distress

Address: GROUP 1 ▶

Category: Routine

Call Frequency: 12577.5 ▶

Mode: Telephony

Voice Frequency: 4146.0 ▶

Home Call

Rotate CH/GRP + Push ENT

8. Select "Voice Frequency."

Compose Non-Distress

Address: GROUP 1 ▶

Category: Routine

Call Frequency: 12577.5 ▶

Mode: Telephony

Voice Frequency: 1735.0 ▶

Home Call

Rotate CH/GRP + Push ENT

① See page 25 for details of the Software Key functions in the DSC Task mode.

11. Hold down [PTT] to communicate.  
 12. Push [Home] to return to the Main screen.

9. Select a Voice frequency, or "Manual Input." (Example: CH 4-1)

Voice Frequency

Manual Input

Channel

Home

Rotate CH/GRP + Push ENT

Channel

User Channel

ITU Simplex Channel (4MHz)

ITU Simplex Channel (6MHz)

ITU Simplex Channel (8MHz)

ITU Simplex Channel (12MHz)

Home

Rotate CH/GRP + Push ENT

■ Sending DSC calls (Other)

◇ Sending a Geographic Area call

Send a Geographic Area call when urgency or safety message announcement is necessary to the vessels in the particular area.

1. Push [Compose Other] .
  - The “Compose Non-Distress” screen is displayed.
  - ① To display the screen from the Menu screen:

[MENU] > **Compose Other**

2. Select “Message Type.”

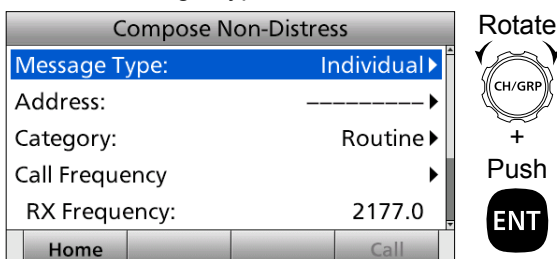

Compose Non-Distress

Message Type: Individual

Address: ----->

Category: Routine

Call Frequency

RX Frequency: 2177.0

Home Call

Rotate CH/GRP + Push ENT

3. Select “Geographic Area.”

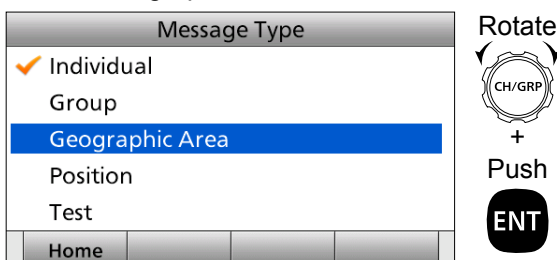

Message Type

Individual

Group

Geographic Area

Position

Test

Home

Rotate CH/GRP + Push ENT

4. Select “Area.”

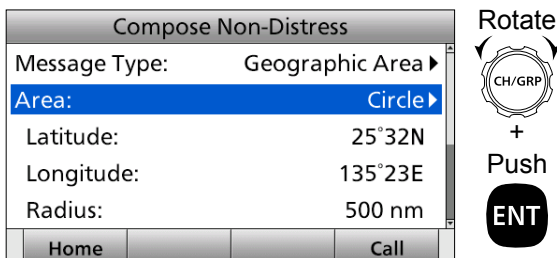

Compose Non-Distress

Message Type: Geographic Area

Area: Circle

Latitude: 25°32N

Longitude: 135°23E

Radius: 500 nm

Home Call

Rotate CH/GRP + Push ENT

5. Select “Circle” or “Quadrant.”

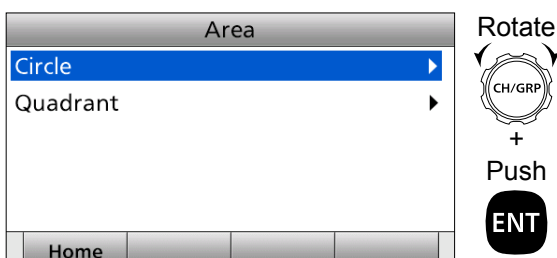

Area

Circle

Quadrant

Home

Rotate CH/GRP + Push ENT

- Circle: See the following steps.
- Quadrant: See the next page.

**When selecting “Circle”:**

You can send a Geographic Area call within the area covered by a set nautical mile radius from your position.

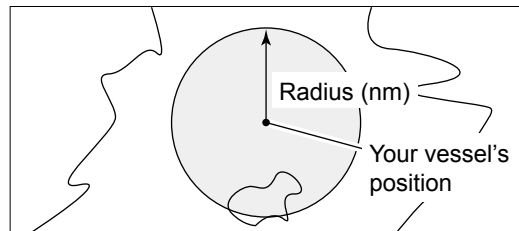

- 1 Enter the latitude of your position. After entering, select “Next” and push [ENT].

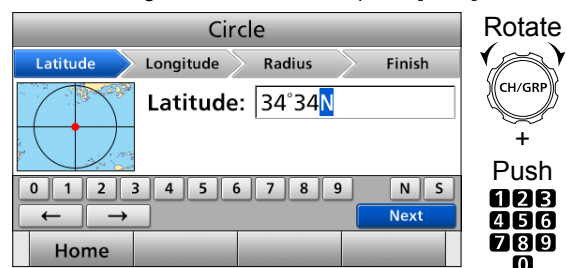

Circle

Latitude Longitude Radius Finish

Latitude: 34°34N

0 1 2 3 4 5 6 7 8 9 N S

← → Next

Home

Rotate CH/GRP + Push keypad

- ① Displays your vessel's position data as the default.
- ① To select 'N' (North latitude) or 'S' (South latitude), select “N” or “S” on the screen and push [ENT], or push a Keypad key when the cursor is on the 'N' or 'S.'

- 2 Enter the longitude of your position. After entering, select “Next” and push [ENT].

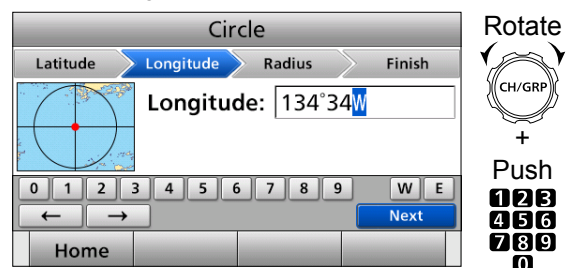

Circle

Latitude Longitude Radius Finish

Longitude: 134°34W

0 1 2 3 4 5 6 7 8 9 W E

← → Next

Home

Rotate CH/GRP + Push keypad

- ① Displays your vessel's position data as the default.
- ① To select 'W' (West longitude) or 'E' (East longitude), select “W” or “E” on the screen and push [ENT], or push a Keypad key when the cursor is on the 'W' or 'E.'

- 3 Enter the radius of the Geographic Area call area. After entering, select “Finish” and push [ENT].

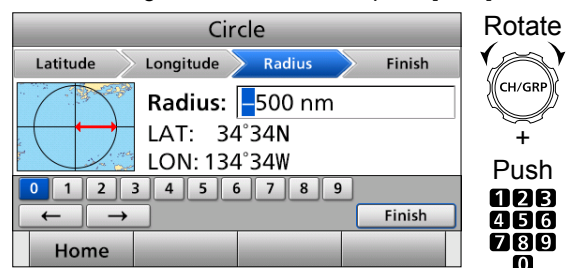

Circle

Latitude Longitude Radius Finish

Radius: 500 nm

LAT: 34°34N

LON: 134°34W

0 1 2 3 4 5 6 7 8 9

← → Finish

Home

Rotate CH/GRP + Push keypad

- 4 Go to step 6 on the next page.

**When selecting “Quadrant”:**  
 You can send a Geographic Area call within the square area as shown below. Your position is the upper left corner of the square.

• **Example**  
 Latitude: 20°N      Height: 10°  
 Longitude: 100°W      Width: 20°

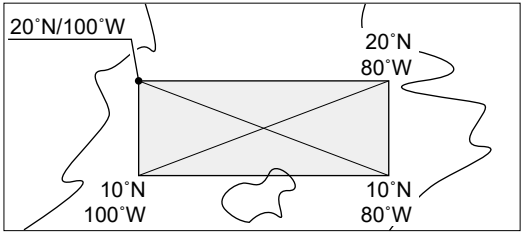

1 Enter the latitude of your position.  
 After entering, select “Next” and push [ENT].

① Displays your vessel’s position data as the default.  
 ① To select ‘N’ (North latitude) or ‘S’ (South latitude), select “N” or “S” on the screen and push [ENT], or push a Keypad key when the cursor is on the ‘N’ or ‘S.’

2 Enter the longitude of your position.  
 After entering, select “Next” and push [ENT].

① Displays your vessel’s position data as the default.  
 ① To select ‘W’ (West longitude) or ‘E’ (East longitude), select “W” or “E” on the screen and push [ENT], or push a Keypad key when the cursor is on the ‘W’ or ‘E.’

3 Enter the height of the Geographic Area call area.  
 After entering, select “Next” and push [ENT].

4 Enter the width of the Geographic Area call area.  
 After entering, select “Finish” and push [ENT].

5 Go to step 6, as shown below.

6. Select “Category.”  
 ① The displayed items may differ depending on the selected option in “Area.”

7. Select an option. (Example: Safety)

8. Select “Call Frequency.”

9. Select an option. (Example: 8414.5 kHz)

► Continued on the next page.

■ Sending DSC calls (Other)

◇ Sending a Geographic Area call (continued)

10. Select "Voice Frequency."

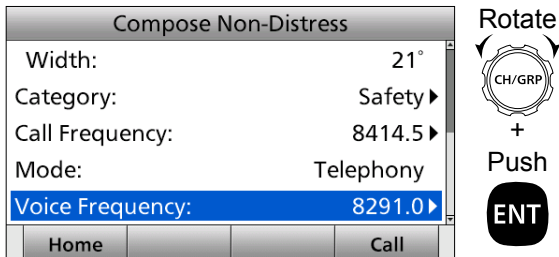

11. Select a voice frequency, or "Manual Input." (Example: CH 4-1)

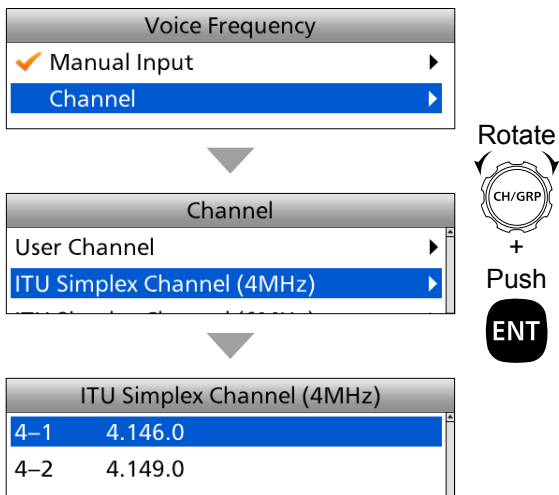

**NOTE:** When you select "Manual Input" in this step, push the keypad to manually enter a communication frequency.

12. Push [Call] to send the Geographic Area call.  
• "Transmitting Geographical call" is displayed, and then "Geographical call" is displayed.

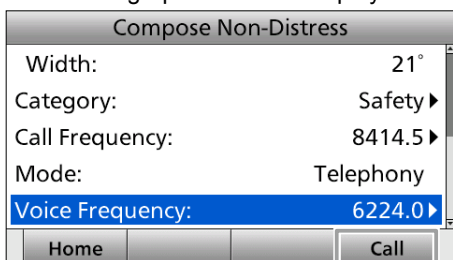

① See page 25 for details of the Software Key functions in the DSC Task mode.

13. Hold down [PTT] to communicate.

14. Push [Home] to return to the Main screen.

◇ Sending a Position Request call

Send a Position Request call when you want to know a specific vessel's current position, and so on.

1. Push [Compose Other] .  
• The "Compose Non-Distress" screen is displayed.  
① To display the screen from the Menu screen:

[MENU] > **Compose Other**

2. Select "Message Type."

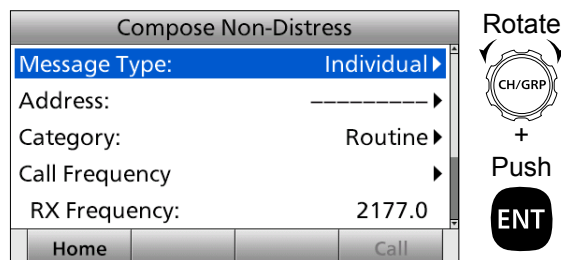

3. Select "Position."

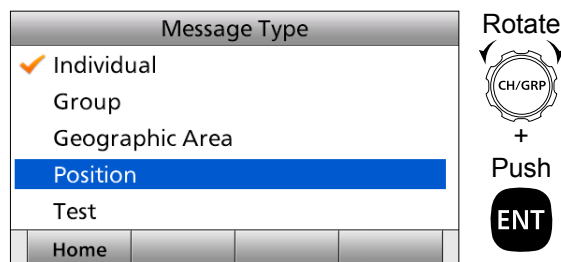

4. Select "Address."

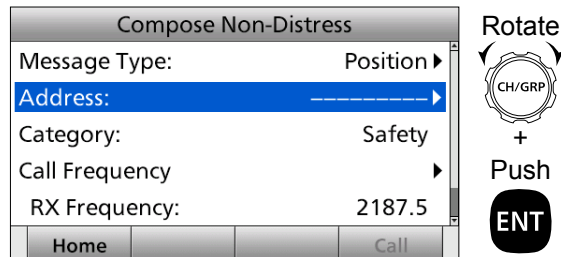

5. Select an Individual ID, or "Manual Input." (Example: STATION A)

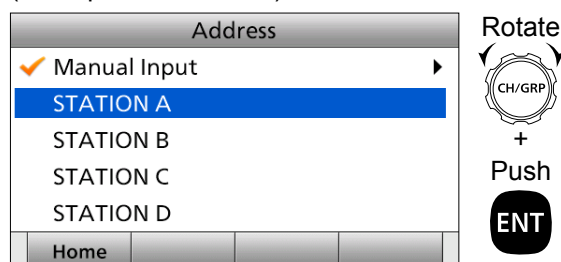

**NOTE:** When you select "Manual Input" in this step, push the keypad to manually enter an Individual ID.



6. Select "Call Frequency."

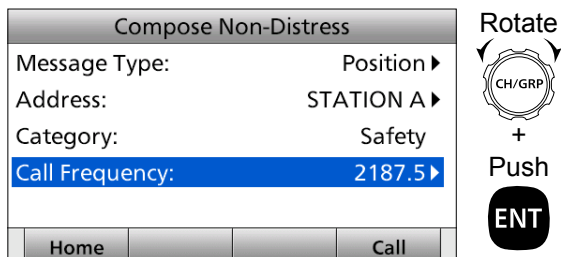

7. Select an option. (Example: 8414.5 kHz)

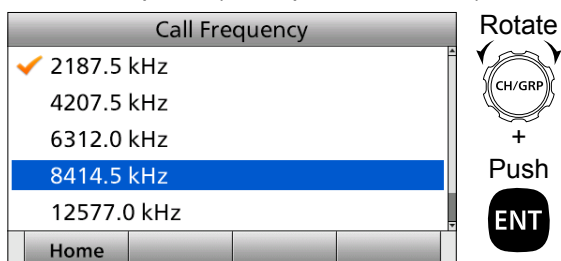

8. Push [Call]  to send the Position Request call.  
 • "Transmitting Position Request" is displayed, and then "Position Call" is displayed.

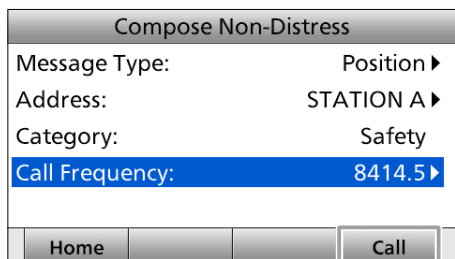

① See page 25 for details of the Software Key functions in the DSC Task mode.



9. Push [Home]  to return to the Main screen.

### ◇ Sending a Position Request Acknowledgment

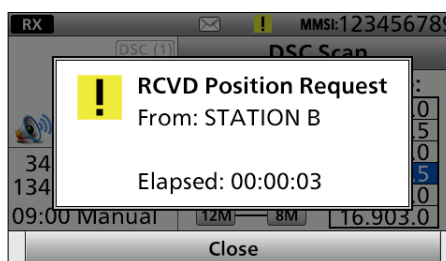

When you have received a Position Request call, send an Acknowledgment to the calling station. When "Position ACK" is set to "Manual" (p. 65), do the following steps to send an Acknowledgment.

- When a Position Request call is received:
  - Alarm sounds.
  - The following screen is displayed.
  - The backlight blinks when the BAM function (p. 18) is OFF.

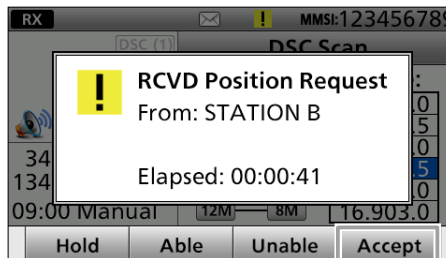

- Push [Close] .
  - ① When the BAM function (p. 18) is OFF: Push [Alarm Off] .
- Push [Accept] .
  - Enters the DSC Task mode.



- ① If you want to immediately send an Acknowledgment "Able to comply" or "Unable to comply," push [Able]  or [Unable] .
- ① If you want to put the task on hold, push [Hold] .

► Continued on the next page.

■ Sending DSC calls (Other)

◇ Sending a Position Request Acknowledgment (continued)

- Select the desired action.
  - The Call Contents screen is displayed.

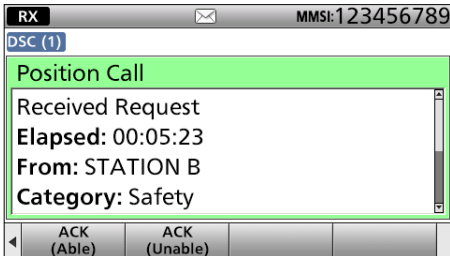

**TIPS:**

**[ACK (Able)]** (Able to comply):  
Sends an Acknowledgment with the position and time data.  
**[ACK (Unable)]** (Unable to comply):  
Sends an Acknowledgment with no position and time data.

- ① Rotate [CH/GRP] to view the call contents.
- ① Change your position data, if the displayed data is invalid. (p. 24)

- Push [Call] to send the Position Request Acknowledgment.
  - Your position data and time are transmitted.

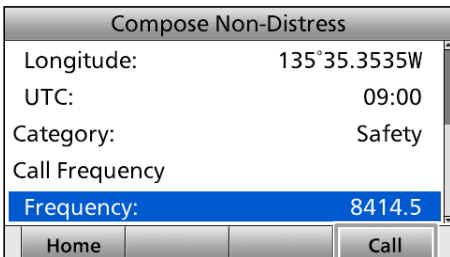

- Push [Home] to return to the Main screen.

**TIP:** When "Position ACK" is set to "Auto (Able)," the transceiver automatically replies to the call. (p. 65)

◇ Sending a Polling Request Acknowledgment

When a Polling Request is received, you can send an Acknowledgment.

- When a Polling Request call is received:
  - Alarm sounds.
  - The following screen is displayed.
  - The backlight blinks when the BAM function (p. 18) is OFF.

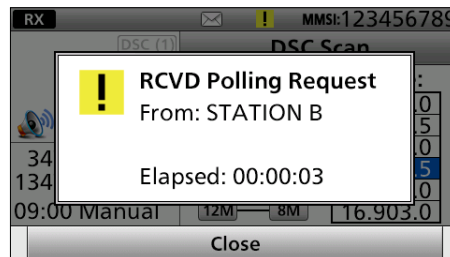

- Push [Close] .
  - ① When the BAM function (p. 18) is OFF: Push [Alarm Off] .
- Push [Accept] .
  - Enters the DSC Task mode.

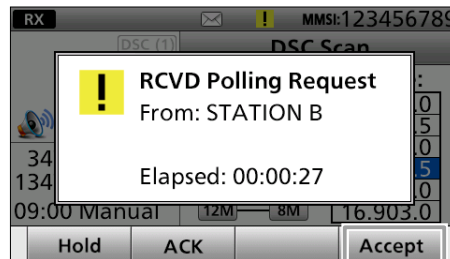

- ① If you want to immediately send an Acknowledgment "Able to comply," push [ACK] .
- ① If you want to put the task on hold, push [Hold] .

- Push [ACK] .
  - The call contents screen is displayed.
  - Rotate [CH/GRP] to view the call contents.

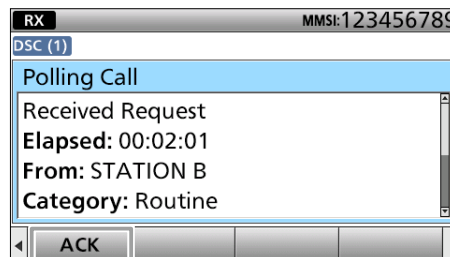

- Push [Call] to send the Polling Request Acknowledgment.

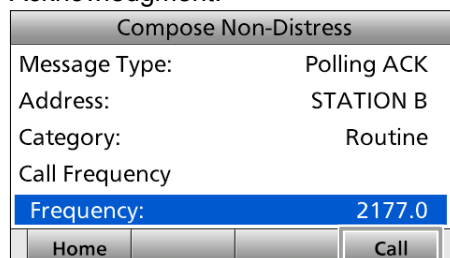

- Your position data and time are transmitted.

- Push [Home] to return to the Main screen.

**TIP:** When "Polling ACK" is set to "Auto," the transceiver automatically replies to the call. (p. 65)

### ◇ Sending a Test call

You should avoid sending Test calls on the exclusive DSC Distress channels and the safety calling channels. If you cannot avoid testing on a Distress or safety channel, you should indicate that these are test calls. Usually, the Test call would require no further calls between the two stations involved.

① You can send a Test call to a pre-entered Individual ID or manually enter the target station ID before sending. (p. 22)

1. Push [Compose Other] .
  - The “Compose Non-Distress” screen is displayed.
  - ① To display the screen from the Menu screen:

[MENU] > **Compose Other**

2. Select “Message Type.”

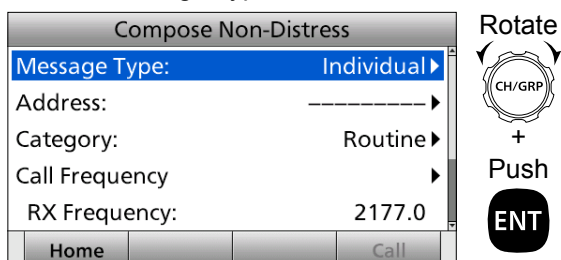

3. Select “Test.”

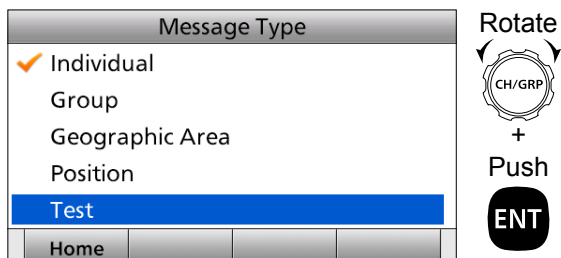

4. Select “Address.”

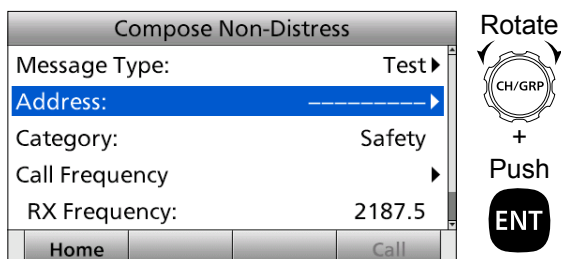

5. Select an Individual ID, or “Manual Input.” (Example: STATION A)

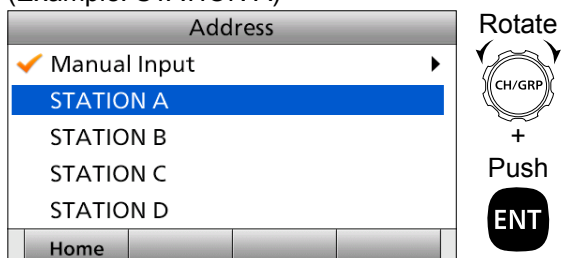

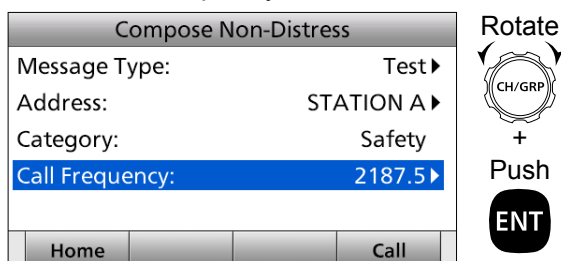

**NOTE:** When you select “Manual Input” in this step, push the keypad to manually enter an Individual ID.

6. Select “Call Frequency.”

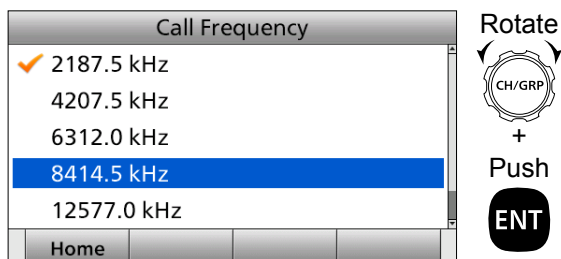

7. Select an option. (Example: 8414.5 kHz)



8. Push [Call]  to send the Test call.
  - “Transmitting Test Call” is displayed, and then “Test Call” is displayed.

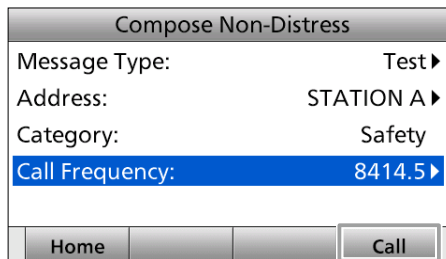

① See page 25 for details of the software key function in the DSC Task mode.

9. Push [Home]  to return to the Main screen.

■ Sending DSC calls (Other)

◇ Sending a Test call Acknowledgment

When you have received a Test call (p. 60), send an Acknowledgment to the calling station. When “Test ACK” is set to “Manual” (p. 65), do the following steps to send an Acknowledgment.

1. When a Test call is received:
  - Alarm sounds.
  - The following screen is displayed.
  - The backlight blinks when the BAM function (p. 18) is OFF.

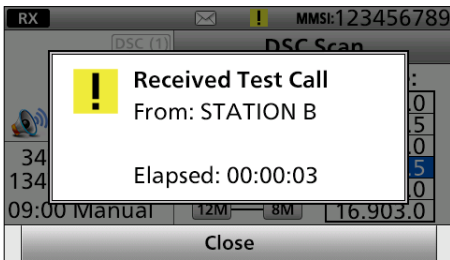

2. Push [Close] .
  - ①When the BAM function (p. 18) is OFF: Push [Alarm Off] .
3. Push [Accept] .

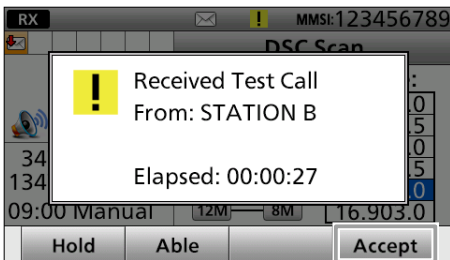

- Enters the DSC Task mode.
- ①If you want to immediately send an Acknowledgment “Able to comply,” push [Able] .
- ①If you want to put the task on hold, push [Hold] .

4. Push [ACK] .

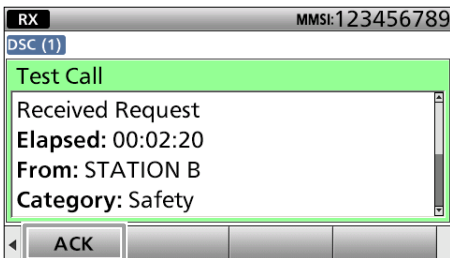

- The call contents screen is displayed.
- Rotate [CH/GRP] to view the call contents.

5. Push [Call] to send the Test call Acknowledgment.

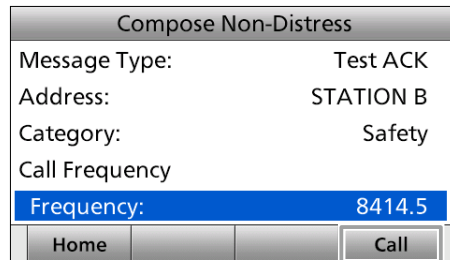

6. Push [Home] to return to the Main screen.

**TIP:** When “Test ACK” is set to Auto, the transceiver automatically replies to the call. (p. 18)

### ◇ Sending a Medical Transports call or Ships and Aircraft call

The Medical Transports call informs all vessels, by urgency priority, that your vessel is carrying a patient in need of medical treatment.

The Ships and Aircraft call informs all vessels that your vessel is a neutral (not a participant) in armed conflict. Be sure to send the call **BEFORE** entering an area of armed conflict.

**NOTE:** You should set the “Medical Transports” or “Ships and Aircraft” item to ON in advance. (p. 65)

1. Push [Compose Other] .
  - The “Compose Non-Distress” screen is displayed.

① To display the screen from the Menu screen:

[MENU] > **Compose Other**

2. Select “Message Type.”

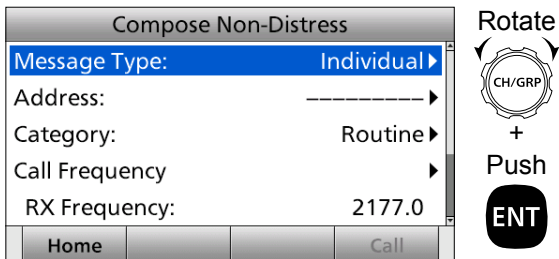

3. Select “Medical Transports” or “Ships and Aircraft.” (Example: Medical Transports)

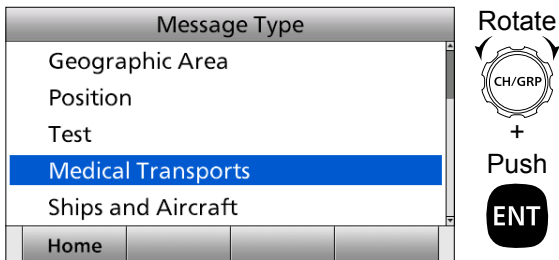

4. Select “Area.”

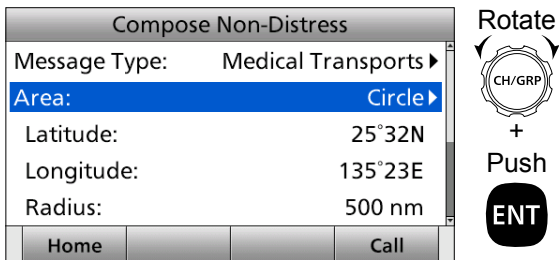

5. Select “Circle” or “Quadrant.”

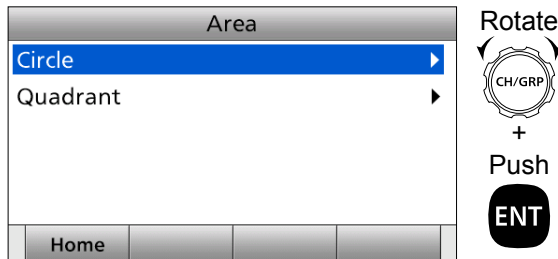

- Circle: See the following steps.
- Quadrant: See the next page.

#### When selecting “Circle”:

You can send a Medical Transports call or Ships and Aircraft call within the area covered by a set nautical mile radius from your position.

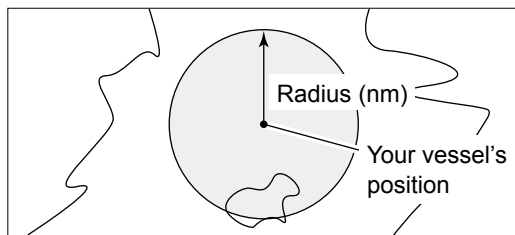

- 1 Enter the latitude of your position. After entering, select “Next” and push [ENT].

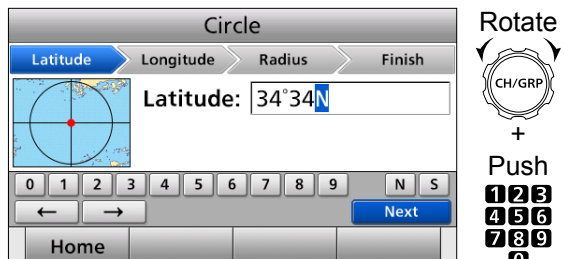

- ① Displays your vessel’s position data as the default.
- ① To select ‘N’ (North latitude) or ‘S’ (South latitude), select “N” or “S” on the screen and push [ENT], or push a Keypad key when the cursor is on the ‘N’ or ‘S.’

- 2 Enter the longitude of your position. After entering, select “Next” and push [ENT].

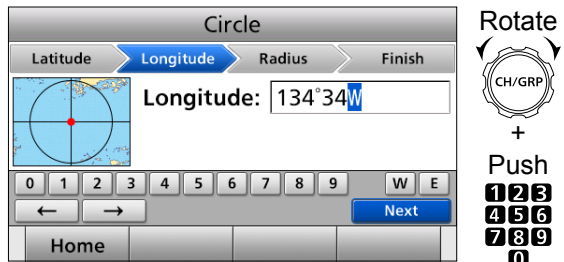

- ① Displays your vessel’s position data as the default.
- ① To select ‘W’ (West longitude) or ‘E’ (East longitude), select “W” or “E” on the screen and push [ENT], or push a Keypad key when the cursor is on the ‘W’ or ‘E.’

► Continued on the next page.

■ Sending DSC calls (Other)

◇ Sending a Medical Transports call or Ships and Aircraft call (continued)

3 Enter the radius of the Medical Transports call or Ships and Aircraft call area. After entering, select "Finish" and push [ENT].

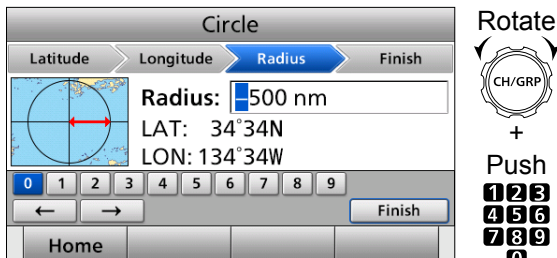

4 Go to step 6 on the next page.

**When selecting "Quadrant":**

You can send a Medical Transports call or Ships and Aircraft call within the square area as shown below. Your position is the upper left corner of the square.

• **Example**

Latitude: 20°N      Height: 10°  
 Longitude: 100°W      Width: 20°

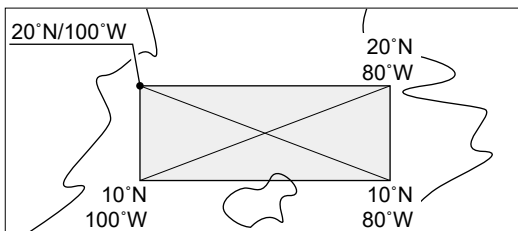

1 Enter the latitude of your position. After entering, select "Next" and push [ENT].

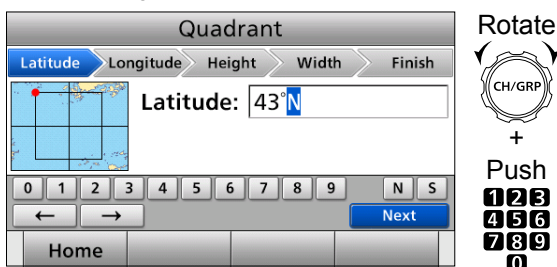

① Displays your vessel's position data as the default.  
 ② To select 'N' (North latitude) or 'S' (South latitude), select "N" or "S" on the screen and push [ENT], or push a Keypad key when the cursor is on the 'N' or 'S.'

2 Enter the longitude of your position. After entering, select "Next" and push [ENT].

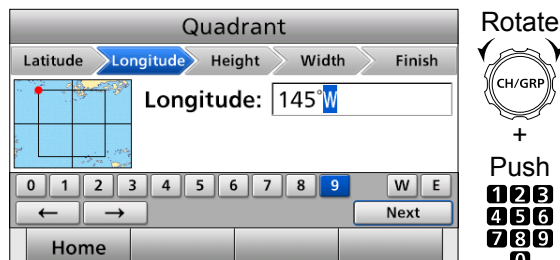

① Displays your vessel's position data as the default.  
 ② To select 'W' (West longitude) or 'E' (East longitude), select "W" or "E" on the screen and push [ENT], or push a Keypad key when the cursor is on the 'W' or 'E.'

3 Enter the height of the Medical Transports call or Ships and Aircraft call area. After entering, select "Next" and push [ENT].

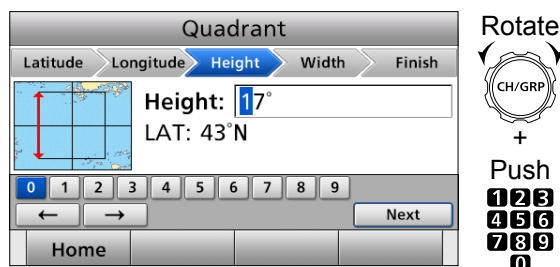

4 Enter the width of the Geographic Area call area. After entering, select "Finish" and push [ENT].

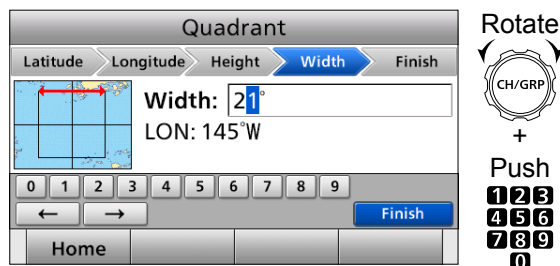

5 Go to step 6, as shown below.

6. Select "Call Frequency."

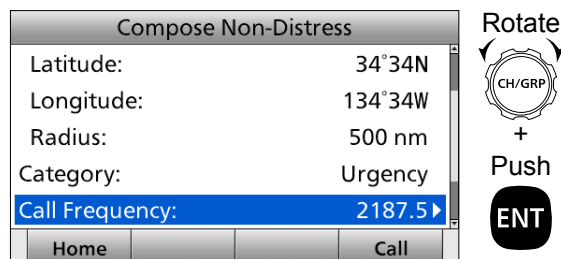

7. Select an option. (Example: 8414.5 kHz)

Call Frequency

- 2187.5 kHz
- 4207.5 kHz
- 6312.0 kHz
- 8414.5 kHz**
- 12577.0 kHz

Home

Rotate (CH/GRP)  
+  
Push  
ENT

8. Select "Voice Frequency."

Compose Non-Distress

Radius: 500 nm  
Category: Urgency  
Call Frequency: 8414.5 ▶  
Mode: Telephony  
**Voice Frequency: 8291.0 ▶**

Home Call

Rotate (CH/GRP)  
+  
Push  
ENT

9. Select a communication frequency, or "Manual Input." (Example: CH 4-1)

Voice Frequency

- Manual Input ▶
- Channel ▶**

Home

Rotate (CH/GRP)  
+  
Push  
ENT

Channel

- User Channel ▶
- ITU Simplex Channel (4MHz) ▶**
- ITU Simplex Channel (6MHz) ▶
- ITU Simplex Channel (8MHz) ▶
- ITU Simplex Channel (12MHz) ▶

Home

Rotate (CH/GRP)  
+  
Push  
ENT

ITU Simplex Channel (4MHz)

- 4-1 4.146.0**
- 4-2 4.149.0
- 4-3 ---.---.-
- 4-4 ---.---.-
- 4-5 ---.---.-

Home

Rotate (CH/GRP)  
+  
Push  
ENT

**NOTE:** When you select "Manual Input" in this step, push the keypad to manually enter a communication frequency.

10. Push [Call] to send the Medical Transports or Ships and Aircraft call. (Example: Medical Transports call)  
• "Transmitting Medical Transports" is displayed, and then "Medical Transports" is displayed.

Compose Non-Distress

Radius: 500 nm  
Category: Urgency  
Call Frequency: 8414.5 ▶  
Mode: Telephony  
**Voice Frequency: 8294.0 ▶**

Home Call

① See page 25 for details of the software key functions in the DSC Task mode.

11. Hold down [PTT] to communicate.  
12. Push [Home] to return to the Main screen.

## ■ Receiving DSC calls

The transceiver receives Distress calls, Distress Acknowledgments, Distress Cancel calls, Distress Relay calls, and Distress Relay Acknowledgments. When you receive a call, an Emergency Alarm sounds.

**NOTE: After receiving a DSC call**

- “DSC (1)” is continuously displayed when the transceiver has DSC tasks.
- “✉” is displayed when there are unread DSC messages.
- “✉” blinks when a DSC message is received. (p. 62)

**When receiving a Distress Cancel call or an acknowledgment:**

- The popup screen may be displayed, even when the BAM function is ON, if you deleted the task before receiving a Distress Cancel call or an acknowledgment.
- The displayed contents may differ, depending on the operating screen.

### ◇ Receiving a Distress Call

**IMPORTANT:**

Distress call reception should stop after one sequence because the coast station should send back an Acknowledgment to the vessel. If the Distress call continues, even after the coast station sends back an Acknowledgment, the vessel in distress may not have received it. In such cases, you should send back an ‘Acknowledgment’ instead of the coast station and contact the coast station. (p. 31)

1. When a Distress call is received:
  - Alarm sounds.
  - The following screen is displayed.
  - The backlight blinks when the BAM function (p. 18) is OFF.

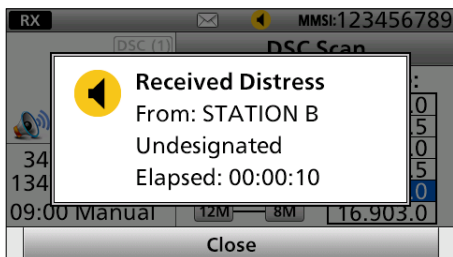

2. Push [Close] .
  - ① When the BAM function (p. 18) is OFF: Push [Alarm Off] .

3. Push the Software Key below the intended operation.
  - ① To send an Acknowledgment, push [Accept] .

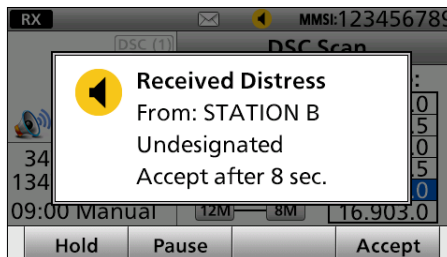

- [Hold] : Puts the RX task on hold and returns to the Main screen.
- [Pause] : Pauses the countdown.
- [Accept] : Enters the DSC Task mode immediately.

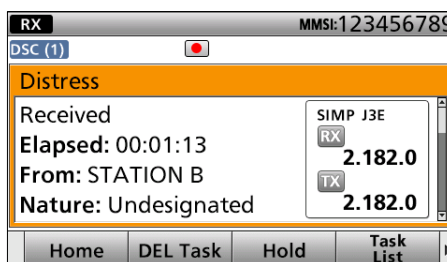

**① Information**

- One of the Emergency frequencies is automatically selected. Monitor it, because a coast station may require assistance.
- Rotate [CH/GRP] to view the call contents.
- ① See page 25 for details of the software key functions in the DSC Task mode.

**NOTE:** When you select [Accept] in step 2, you can send the Relay call in the DSC Task mode. To send the Relay call, go to step 4. If you return to the Main screen without sending the Relay call, go to step 10.

4. Push [Relay] .

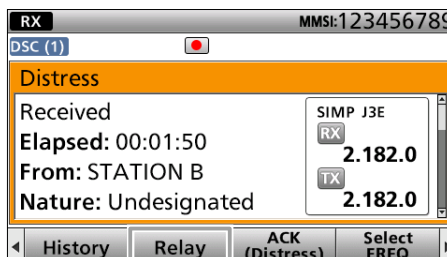

5. When the confirmation screen is displayed, push [OK].
6. Select “Address,” then push [ENT].
7. Select the desired Individual address, or “Manual Input,” then push [ENT].



- Select your desired Individual ID, or “Manual Input.” (Example: STATION A)

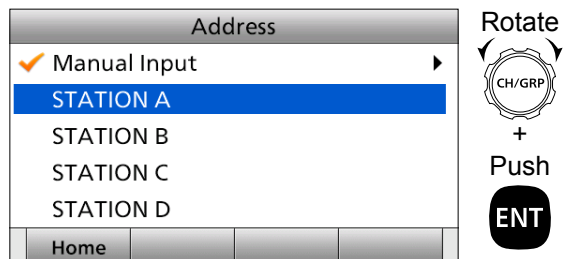

**NOTE:** When you select “Manual Input” in this step, push the keypad to manually enter your desired Individual ID.

- Push [Call] to send the Relay call.
- Push [Home] to return to the Main screen.

**TIP:**

- See page 31 for details of sending an Acknowledgment.
- When you push [Pause] in step 2, the countdown will be paused. Push [Resume Countdown] to restart the countdown.

### ◇ Receiving a Distress Acknowledgment

- When a Distress Acknowledgment is received:
  - Alarm sounds.
  - The following screen is displayed.
  - The backlight blinks when the BAM function (p. 18) is OFF.

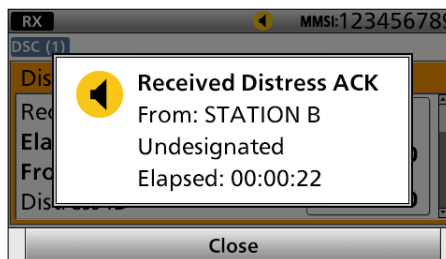

- Push [Close] .
  - Enters the DSC Task mode.
  - ①When the BAM function (p. 18) is OFF: Push [Alarm Off] , and then push [Close Call RCVD Window] .

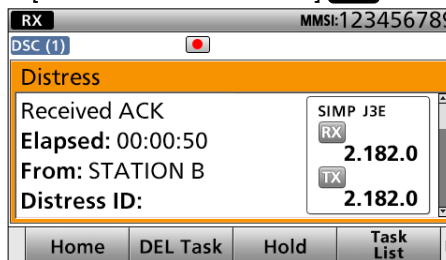

#### ① Information

- The communication frequency is automatically selected. Monitor it, because a coast station may require assistance.
  - Rotate [CH/GRP] to view the call contents.
  - ① See page 25 for details of the software key functions in the DSC Task mode.
- Push [Home] to return to the Main screen.

■ Receiving DSC calls

◇ Receiving a Distress Cancel call

- When a Distress Cancel call is received:
  - Alarm sounds.
  - The following screen is displayed.
  - The backlight blinks when the BAM function (p. 18) is OFF.

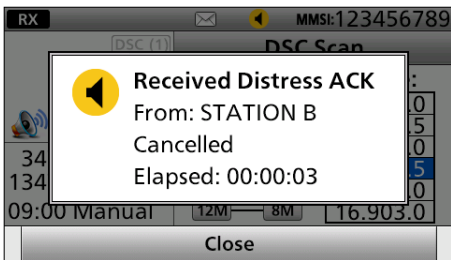

- Push [Close] .
  - ① When the BAM function (p. 18) is OFF: Push [Alarm Off] .
- Select your desired action.
  - ① To send an Acknowledgment, push [Accept] .

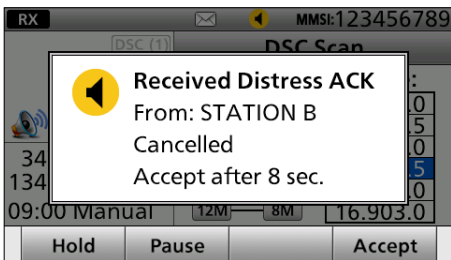

- [Hold] : Puts the RX task on hold and returns to the Main screen.  
 [Pause] : Pauses the countdown.  
 [Accept] : Enters the DSC Task mode immediately.

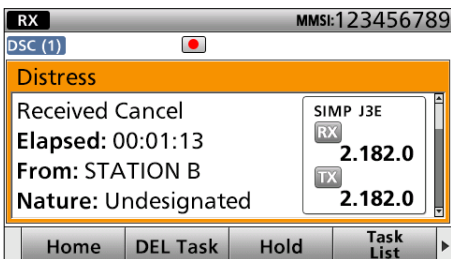

① Information

- The communication frequency is automatically selected. Monitor it, because a coast station may require assistance.
  - Rotate [CH/GRP] to view the call contents.
  - ① See page 25 for details of the software key functions in the DSC Task mode.
- Push [Home] to return to the Main screen.

**TIP:** When you push [Pause] in step 2, the countdown will be paused. Push [Resume Countdown] to restart the countdown.

◇ Receiving a Distress Relay call

- When a Distress Relay call is received:
  - Alarm sounds.
  - The following screen is displayed.
  - The backlight blinks when the BAM function (p. 18) is OFF.

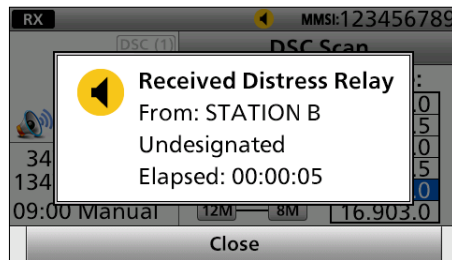

- Push [Close] .
  - ① When the BAM function (p. 18) is OFF: Push [Alarm Off] .
- Select your desired action.
  - ① To send an Acknowledgment, push [Accept] .

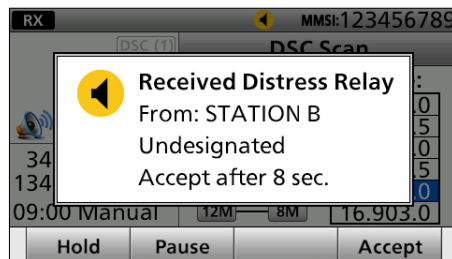

- [Hold] : Puts the RX task on hold and returns to the Main screen.  
 [Pause] : Pauses the countdown.  
 [Accept] : Enters the DSC Task mode immediately.

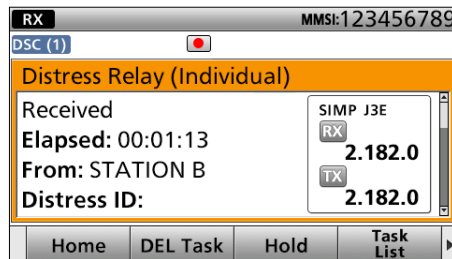

① Information



- The communication frequency is automatically selected. Monitor it, because a coast station may require assistance.
  - Rotate [CH/GRP] to view the call contents.
  - ① See page 25 for details of the Software key functions in the DSC Task mode.
- Push [Home] to return to the Main screen.

**TIP:** When you push [Pause] in step 2, the countdown will be paused. Push [Resume Countdown] to restart the countdown.

## ◇ Receiving a Distress Relay Acknowledgment

- When a Distress Relay Acknowledgment is received:
  - Alarm sounds.
  - The following screen is displayed.



- When the BAM function (p. 18) is OFF:
  - The backlight blinks and the popup screen is displayed.
  - Push [Alarm Off] , and then push [Close Call RCVD Window] .



- Push [Home]  to return to the Main screen.

### ① Information

- The communication frequency is automatically selected. Monitor it, because a coast station may require assistance.
  - Rotate [CH/GRP] to view the call contents.
  - See page 25 for details of the Software key functions in the DSC Task mode.
- Hold down [PTT] to announce your situation.
  - Push [Home]  to return to the Main screen.

## ■ Receiving DSC calls (other)

### ◇ Receiving an Individual call

**NOTE:**

- To receive an Individual call, push [D-SCAN] to enter the DSC watch mode. (p. 10)
- When the “Individual ACK” item is set to “Auto (Unable),” the transceiver automatically sends an Acknowledgment “Unable to comply.” (p. 65)  
In that case, both the TX and RX calls are saved in the Transmitted and Received Call Logs. (p. 62)

1. When an Individual call is received:
  - Alarm sounds.
  - The following screen is displayed.
  - The backlight blinks when the BAM function (p. 18) is OFF.

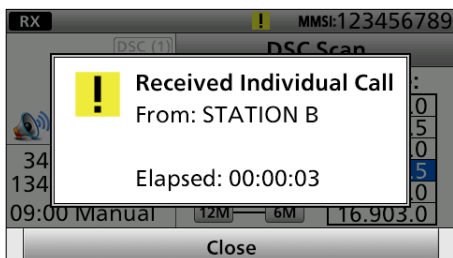

2. Push [Close] .
  - ① When the BAM function (p. 18) is OFF: Push [Alarm Off] .
3. Push the Software Key below the intended operation.
  - ① To send an Acknowledgment, push [Accept] .

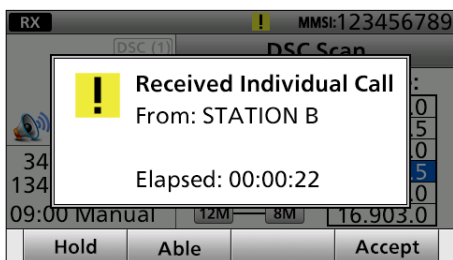

- [Hold] : Puts the RX task on hold and returns to the Main screen.
- [Able] : Sends an Acknowledgment without any changes.
- [Accept] : Enters the DSC Task mode immediately.

**NOTE:** When you select “Accept” in step 3, you can send the Acknowledgment in the DSC Task mode. To send the Acknowledgment, go to step 3. If you return to the Main screen without sending the Acknowledgment, go to step 8.

4. Select the desired action.

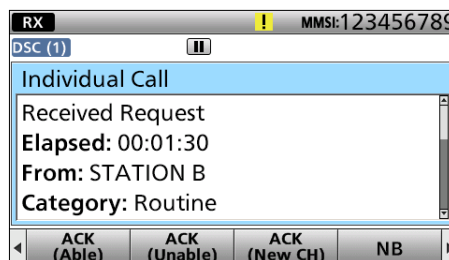

5. Confirm the contents.

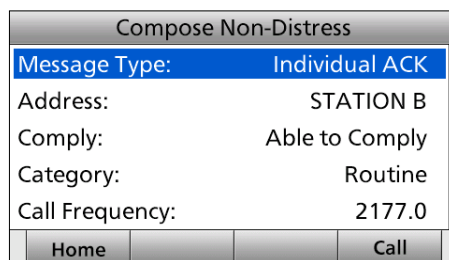

6. Push [Call] to send the Individual Acknowledgment.
7. Hold down [PTT] to communicate normally.
8. After you have finished your call, push [Home] to return to the Main screen.

**TIP:** When sending the Acknowledgment, select one of three options, depending on your situation. See pages 38 for details of the Individual Acknowledgment procedures.



### ◇ Receiving an Individual Acknowledgment

#### When receiving “ACK (able)”:

You can communicate on the frequency specified for sending the call.

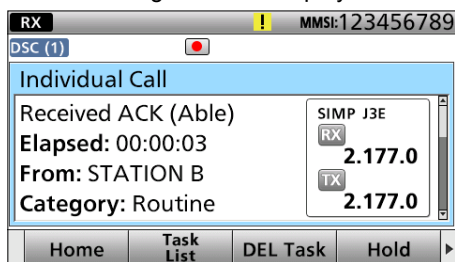
- When “ACK (Able)” is received:
  - Alarm sounds.
  - The following screen is displayed.



- When the BAM function (p. 18) is OFF: The backlight blinks and the popup screen is displayed. Push [Alarm Off] , and then push [Close Call RCVD Window] .

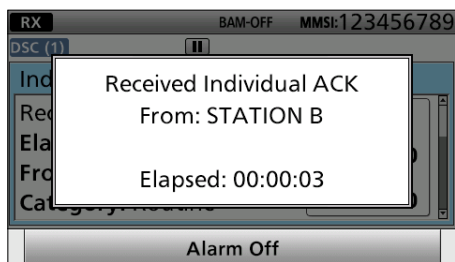

**When the BAM function is OFF.**



- The communication frequency specified when sending the call is automatically selected.
  - Rotate [CH/GRP] to view the call contents.
    - ① See page 25 for details of the software key functions in the DSC Task mode.
- Hold down [PTT] to communicate normally.
  - After you have finished your call, push [Home]  to return to the Main screen.

#### When receiving “ACK (unable)”:

You cannot communicate further.

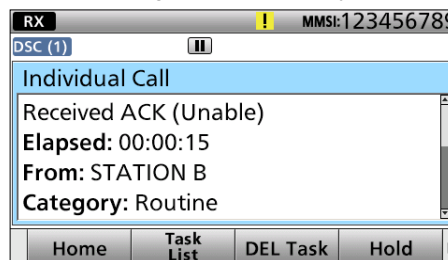
- When “ACK (Unable)” is received:
  - Alarm sounds.
  - The following screen is displayed.



- When the BAM function (p. 18) is OFF: The backlight blinks and the popup screen is displayed. Push [Alarm Off] , and then push [Close Call RCVD Window] .

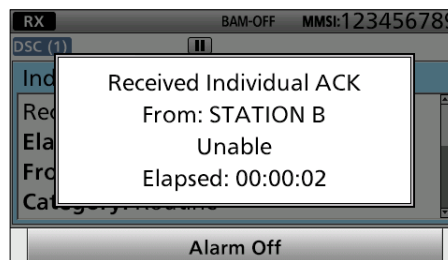

**When the BAM function is OFF.**

- Enters the DSC Task mode.
  - Rotate [CH/GRP] to view the call contents.
    - ① See page 25 for details of the Software key functions in the DSC Task mode.
- Push [Home]  to return to the Main screen.

■ Receiving DSC calls (other)



◇ Receiving an Individual Acknowledgment (continued)

**When receiving “ACK (New CH)”:**

You can communicate on the frequency specified by the called station.

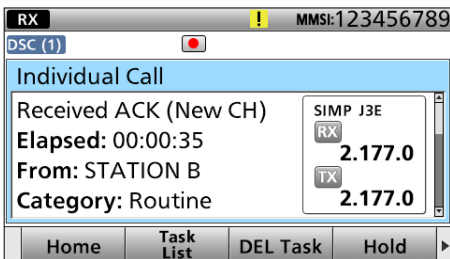
- When “ACK (New CH)” is received:
  - Alarm sounds.
  - The following screen is displayed.



- When the BAM function (p. 18) is OFF: The backlight blinks and the popup screen is displayed. Push [Alarm Off] , and then push [Close Call RCVD Window] .

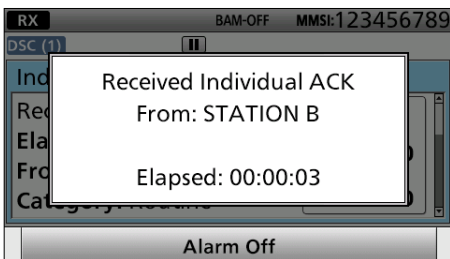

**When the BAM function is OFF.**

- The communication frequency specified by the called station is automatically selected.
  - Rotate [CH/GRP] to view the call contents.
    - ① See page 25 for details of the software key functions in the DSC Task mode.
- Hold down [PTT] to communicate normally.
  - After you have finished your call, push [Home]  to return to the Main screen.



◇ Receiving a Group call

**NOTE:** To receive a Group call, push [D-SCAN] to enter the DSC watch mode. (p. 10)

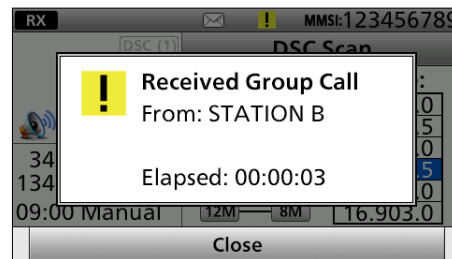

**When a Group call is received:**

- Alarm sounds.
- The following screen is displayed.
- The backlight blinks when the BAM function (p. 18) is OFF.



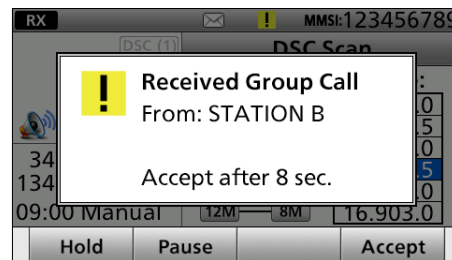

- Push [Close] .
  - ① When the BAM function (p. 18) is OFF: Push [Alarm Off] .
- Push the Software Key below the intended operation.

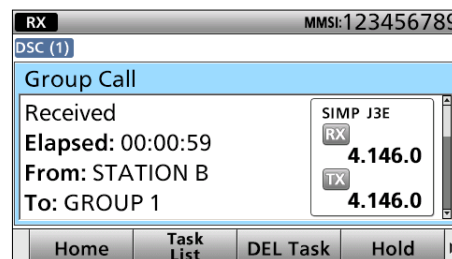

- [Hold] : Puts the RX task on hold and returns to the Main screen.
- [Pause] : Pauses the countdown.
- [Accept] : Enters the DSC Task mode immediately.



- Monitors the communication frequency specified by the calling station.
  - Rotate [CH/GRP] to view the call contents.
    - ① See page 25 for details of the software key functions in the DSC Task mode.
- Push [Home]  to return to the Main screen.

**TIP:** When you push [Pause]  in step 2, the countdown will be paused. Push [Resume Countdown]  to restart the countdown.

### ◇ Receiving a Geographical Area call

- When a Geographical Area call is received:
  - Alarm sounds.
  - The following screen is displayed.
  - The backlight blinks when the BAM function (p. 18) is OFF.

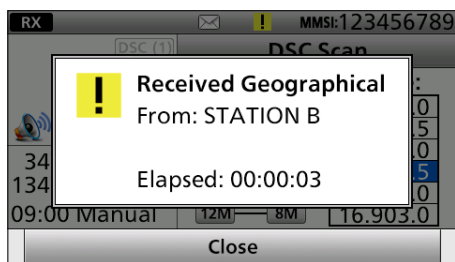

- Push [Close] .
  - ⓐ When the BAM function (p. 18) is OFF: Push [Alarm Off] .
- Push the Software Key below the intended operation.

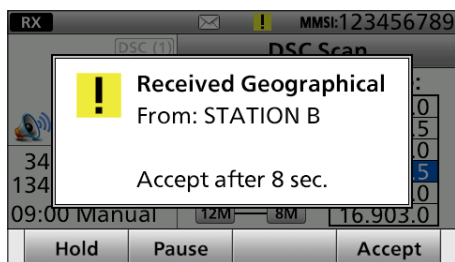

- [Hold] : Puts the RX task on hold and returns to the Main screen.
- [Pause] : Pauses the countdown.
- [Accept] : Enters the DSC Task mode immediately.

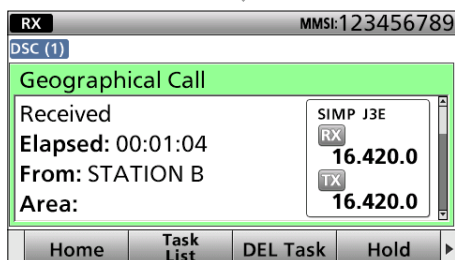

- Monitors the communication frequency specified by the calling station for an announcement from the calling station.
  - Rotate [CH/GRP] to view the call contents.
  - ⓐ See page 25 for details of the software key functions in the DSC Task mode.
- Push [Home] to return to the Main screen.

**TIP:** When you push [Pause] in step 2, the countdown will be paused. Push [Resume Countdown] to restart the countdown.

### ◇ Receiving a Position Request call

**NOTE:** When “Position ACK” is set to “Auto (Able),” the transceiver automatically sends an Acknowledgment. (p. 65)  
In that case, both the TX and RX calls are saved in the Transmitted and Received Call Logs. (p. 62)

#### When a Position Request call is received:

- Alarm sounds.
- The following screen is displayed.
- The backlight blinks when the BAM function (p. 18) is OFF.

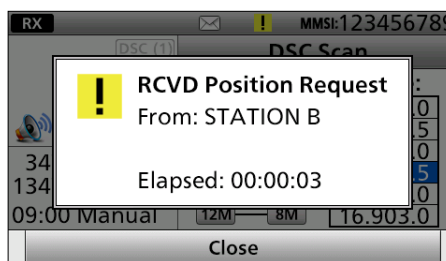

- Push [Close] .
  - ⓐ When the BAM function (p. 18) is OFF: Push [Alarm Off] .
- Push the Software Key below the intended operation.

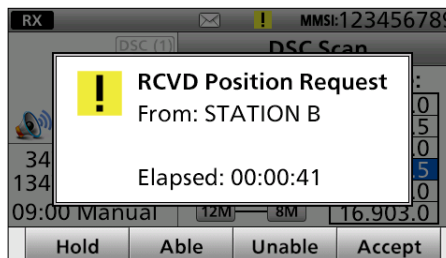

- [Hold] : Puts the RX task on hold and returns to the Main screen.
- [ACK] : Sends an Acknowledgment.
- [Accept] : Enters the DSC Task mode immediately.

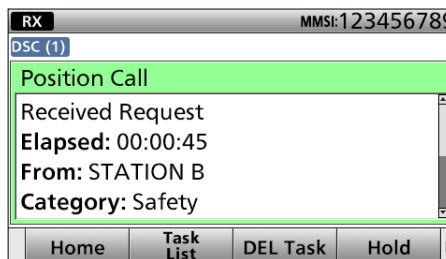

- Rotate [CH/GRP] to view the call contents.
  - ⓐ See page 25 for details of the software key functions in the DSC Task mode.
- Push [Home] to return to the Main screen.



**TIP:** See page 44 for details on sending an Acknowledgment.

■ Receiving DSC calls (other)

◇ Receiving a Position Request Acknowledgment

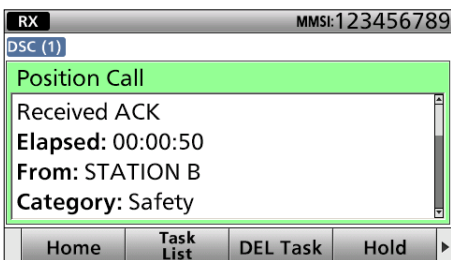
1. When a Position Request Acknowledgment is received:
  - Alarm sounds.
  - The following screen is displayed.



- When the BAM function (p. 18) is OFF: The backlight blinks and the popup screen is displayed. Push [Alarm Off] , and then push [Close Call RCVD Window] .

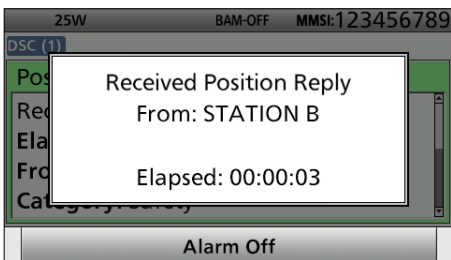

When the BAM function is OFF.



- ① Rotate [CH/GRP] to view the call contents.
- ① See page 25 for details of the software key functions in the DSC Task mode.
2. Push [Home]  to return to the Main screen.

◇ Receiving a Polling Request call

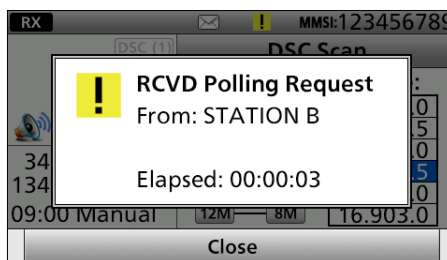

**NOTE:** When “Polling ACK” is set to “Auto,” the transceiver automatically replies to the call. (p. 65) In that case, both the TX and RX calls are stored in the Transmitted and Received Call Logs. (p. 62)

1. When a Polling Request call is received:
  - Alarm sounds.
  - The following screen is displayed.
  - The backlight blinks when the BAM function (p. 18) is OFF.

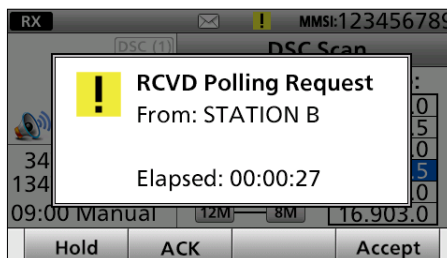

2. Push [Close] .
- ① When the BAM function (p. 18) is OFF: Push [Alarm Off] .
3. Select your desired action.



- [Hold] : Puts the RX task on hold and returns to the Main screen.
- [ACK] : Sends an Acknowledgment.
- [Accept] : Enters the DSC Task mode immediately.

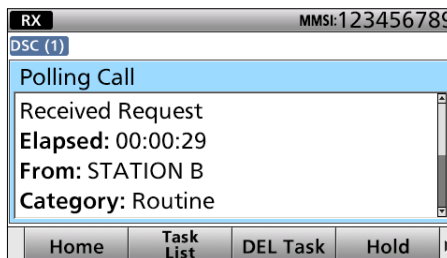

- ① Rotate [CH/GRP] to view the call contents.
- ① See page 25 for details of the Software key functions in the DSC Task mode.
4. Push [Home]  to return to the Main screen.

**TIP:** See page 45 for details on sending an Acknowledgment.



### ◇ Receiving a Test call

**NOTE:** When “Test ACK” is set to “Auto,” the transceiver automatically replies to the call. (p. 65)  
In that case, both the TX and RX calls are stored in the Transmitted and Received Call Logs. (p. 62)

- When a Test call is received:
  - Alarm sounds.
  - The following screen is displayed.
  - The backlight blinks when the BAM function (p. 18) is OFF.

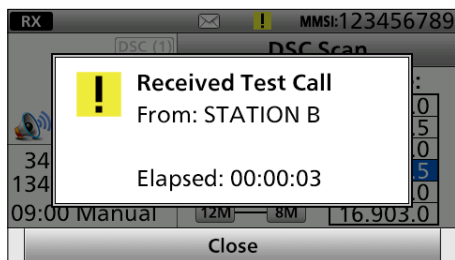

- Push [Close] .
  - ① When the BAM function (p. 18) is OFF: Push [Alarm Off] .
- Select your desired action.

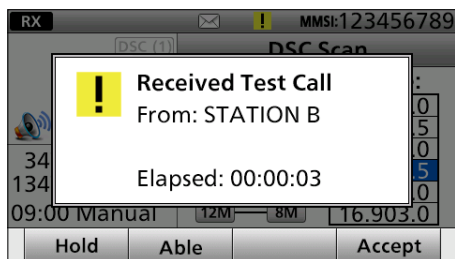

[Hold] : Puts the RX task on hold and returns to the Main screen.

[Able] : Sends an Acknowledgment.

[Accept] : Enters the DSC Task mode immediately.

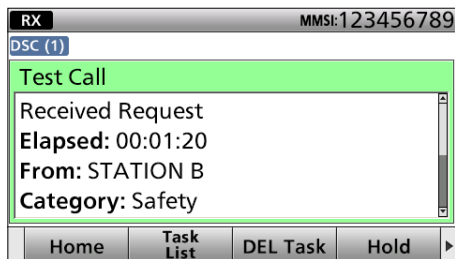

① Rotate [CH/GRP] to view the call contents.

① See page 25 for details of the Software key functions in the DSC Task mode.

- Push [Home] to return to the Main screen.

**TIP:** See page 47 for details on sending an Acknowledgment.

### ◇ Receiving a Test Acknowledgment

- When a Test Acknowledgment is received:
  - Alarm sounds.
  - The following screen is displayed.

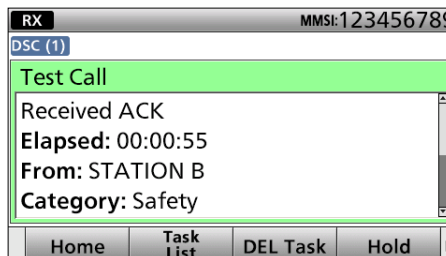

- When the BAM function (p. 18) is OFF: The backlight blinks and the popup screen is displayed. Push [Alarm Off] , and then push [Close Call RCVD Window] .

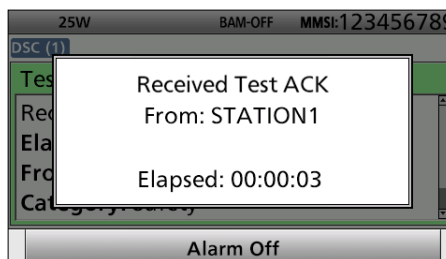

#### When the BAM function is OFF.

- Rotate [CH/GRP] to view the call contents.
  - ① See page 25 for details of the Software key functions in the DSC Task mode.
- Push [Home] to return to the Main screen.

■ Receiving DSC calls (other)

◇ Receiving a Medical Transports call

- When a Medical Transports call is received:
  - Alarm sounds.
  - The following screen is displayed.
  - The backlight blinks when the BAM function (p. 18) is OFF.

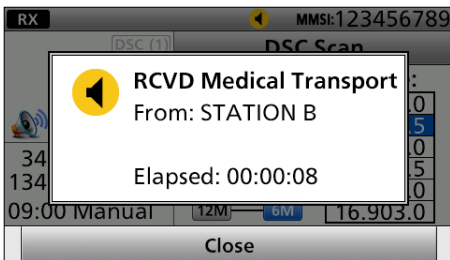

- Push [Close] .
  - ①When the BAM function (p. 18) is OFF: Push [Alarm Off] .
- Select the desired action.

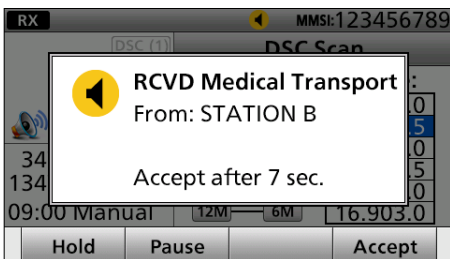

- [Hold] : Puts the RX task on hold and returns to the Main screen.
- [Pause] : Pauses the countdown.
- [Accept] : Enters the DSC Task mode immediately.

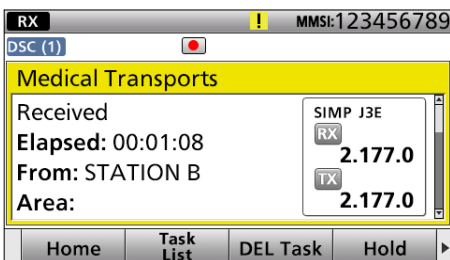

① Information

- Monitors the communication frequency specified by the calling station for an announcement from the calling station.
  - Rotate [CH/GRP] to view the call contents.
  - ① See page 25 for details of the Software key functions in the DSC Task mode.
- Push [Home] to return to the Main screen.

**TIP:** When you push [Pause] in step 2, the countdown will be paused. Push [Resume Countdown] to restart the countdown.

◇ Receiving a Ships and Aircraft call

- When a Ships and Aircraft call is received:
  - Alarm sounds.
  - The following screen is displayed.
  - The backlight blinks when the BAM function (p. 18) is OFF.

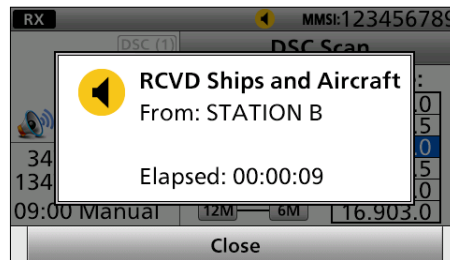

- Push [Close] .
  - ①When the BAM function (p. 18) is OFF: Push [Alarm Off] .
- Select the desired action.

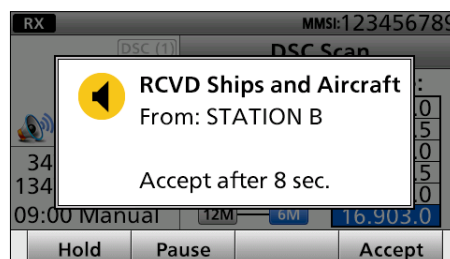

- [Hold] : Puts the RX task on hold and returns to the Main screen.
- [Pause] : Pauses the countdown.
- [Accept] : Enters the DSC Task mode immediately.

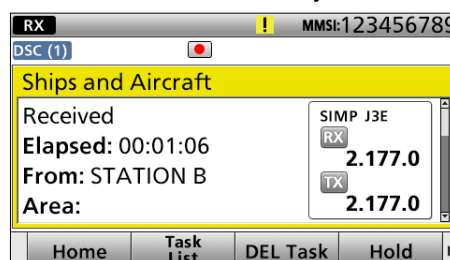

① Information

- Monitors the communication frequency specified by the calling station for an announcement from the calling station.
  - Rotate [CH/GRP] to view the call contents.
  - ① See page 25 for details of the software key functions in the DSC Task mode.
- Push [Home] to return to the Main screen.

**TIP:** When you push [Pause] in step 2, the countdown will be paused. Push [Resume Countdown] to restart the countdown.

## Received Call log

The transceiver automatically stores up to 50 distress messages and 50 other messages, and they can be used as a supplement to your logbook.

### ◇ Distress message

1. Push [DSC Log] to display the Received Call Log screen.

① To display the screen from the Menu screen:

[MENU] > DSC Log > **Received Call Log**

2. Select "Distress," then push [ENT].
3. Select your desired item.

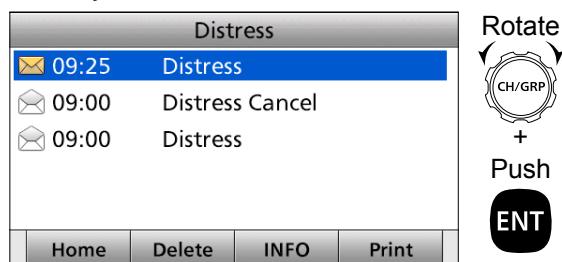

4. Rotate [CH/GRP] to view the contents.
  - ① To view another message, push [CLR] to return to the previous screen. And then, select the desired message.
5. Push [Home] to return to the Standby mode.

### ◇ Other messages

1. Push [DSC Log] to display the Received Call Log screen.
2. Select "Others," then push [ENT].
3. Select a log to display the detailed information.

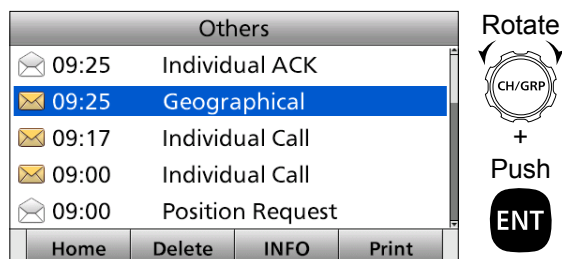

4. Rotate [CH/GRP] to view the contents.
  - ① To view another message, push [CLR] to return to the previous screen. And then, select the desired message.
5. Push [Home] to return to the Standby mode.

#### NOTE:

- When there are unread DSC messages, "✉" is displayed on the Information area of the LCD.
- When a DSC message is received, "✉" blinks on the Information area of the LCD.
- "✉" is displayed when there are unread DSC messages.
- "✉" is displayed when there is no unread DSC message.
- No icon is displayed when there are no DSC messages.
- The Distress messages are stored in "Distress."

## Transmitted Call log

The transceiver automatically stores up to 50 transmitted calls, and the logs can be used as a supplement to your logbook.

1. Open "Transmitted Call Log."

[MENU] > DSC Log > **Transmitted Call Log**

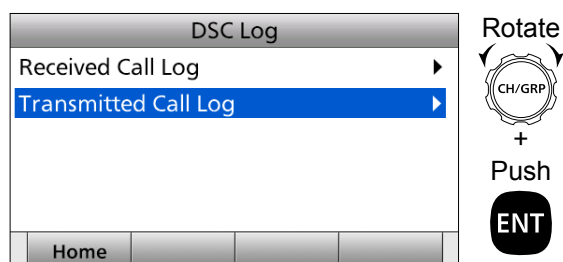

2. Select a log to display the detailed information.

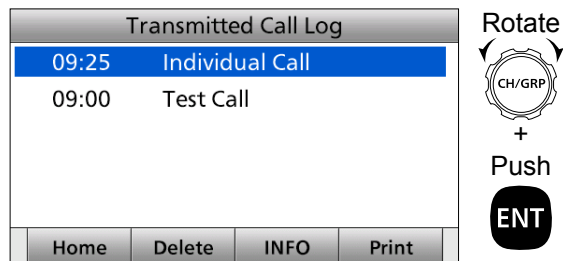

3. Rotate [CH/GRP] to view the contents.
  - ① To view another message, push [CLR] to return to the previous screen. And then, select the desired message.
4. Push [Home] to return to the Standby mode.

#### TIP: Software key functions in the Received Call Log screen and Transmitted Call Log screen:

- [Home]: Push to return to the Main screen.
- [Delete]: Push to delete the selected message.
- [INFO]: Push to display the detailed information.
- [MMSI]: Push to save the MMSI as an Individual ID.
- [Print]: Push to print out the selected message when a printer is connected to the transceiver.

## ■ DSC Settings

- ◇ Position Input (p. 24)
- ◇ Individual ID (p. 22)
- ◇ Group ID (p. 22)

### ◇ DSC Frequency

This set frequencies are selectable when you want to send an Individual call, Group call, Geographic Area call, Position Request call, or Test call. Usually your dealer has set all the DSC frequencies to use.

#### To add a new DSC frequency:

1. Open "DSC Frequency."

[MENU] > Settings > DSC > **DSC Frequency**

2. Select a DSC frequency number. (Example: 50)

DSC Frequency

046	Not Used
047	Not Used
048	Not Used
049	Not Used
<b>050</b>	<b>Not Used</b>

Home Edit Delete Print

Rotate  
CH/GRP  
+  
Push  
ENT

3. Select "Use:."

DSC Frequency (50)

Use: Not Used

Frequency

RX Frequency: -----

TX Frequency: -----

Name:

Home Save

Rotate  
CH/GRP  
+  
Push  
ENT

4. Select an option. (Example: Call)

Use

Voice

**Call**

✓ Not Used

Home

Rotate  
CH/GRP  
+  
Push  
ENT

- Voice: Voice frequency that is used to talk with other station after DSC call communications.
- Call: DSC call frequency that is used to send DSC calls.

5. Select "Frequency."

DSC Frequency (50)

Use: Call

**Frequency**

RX Frequency: -----

TX Frequency: -----

Name:

Home Save

Rotate  
CH/GRP  
+  
Push  
ENT

6. Enter an RX frequency. After entering, select "Next" and push [ENT]. (Example: 4.390.0)

Frequency

RX Frequency TX Frequency Finish

RX Frequency: 4390.0

0 1 2 3 4 5 6 7 8 9

← → Next

Home

Rotate  
CH/GRP  
+  
Push  
1 2 3  
4 5 6  
7 8 9  
0

7. Enter a TX frequency. After entering, select "Finish" and push [ENT]. (Example: 4.098.0)

Frequency

RX Frequency TX Frequency Finish

TX Frequency: 4098.0

0 1 2 3 4 5 6 7 8 9

← → Finish

Home

Rotate  
CH/GRP  
+  
Push  
1 2 3  
4 5 6  
7 8 9  
0

8. Select "Name."

DSC Frequency (50)

Use: Call

Frequency

RX Frequency: 4390.0

TX Frequency: 4098.0

**Name:**

Home Save

Rotate  
CH/GRP  
+  
Push  
ENT

- Enter a DSC frequency name.  
After entering, select "Finish" and push [ENT].

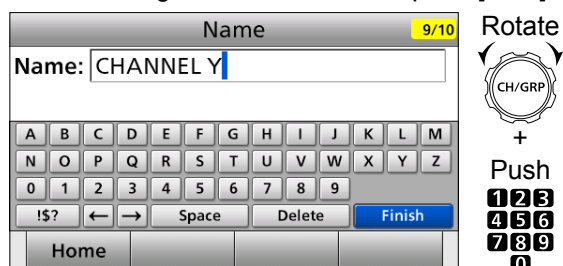

- Push [Save] .
  - "Are you sure?" is displayed.

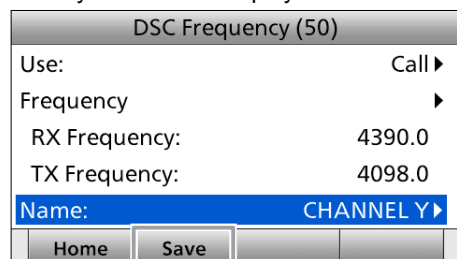

- Push [OK] to save the content.
- Push [▶] to scroll the Software key functions.
- Push [MENU] or [Home] to return to the Main screen.

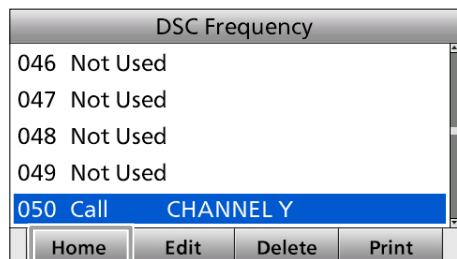

### ◇ Scanning Receiver

You can turn the Scanning Receiver function ON or OFF on each Emergency frequency.

#### When selecting "Distress frequency"

**NOTE:** You cannot turn OFF the function on 2187.5 kHz and 8414.5 kHz, and 1 of the remaining 4 frequencies.

- Open "Distress."

[MENU] > Settings > DSC > Scanning Receiver > **Distress**

- Select a frequency.

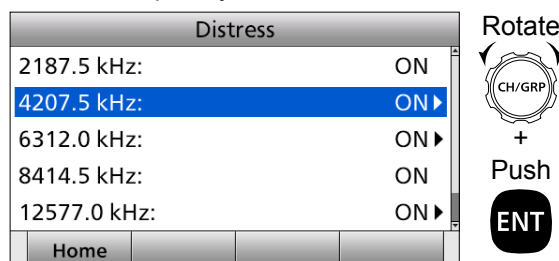

- Select an option.

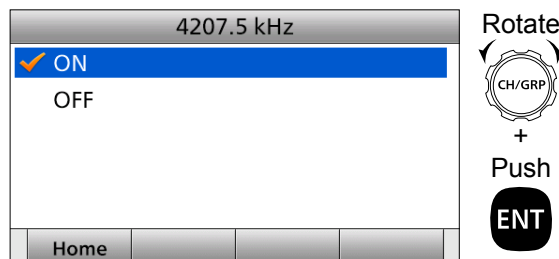

- ON: The Emergency frequency is scanned during the Distress scan.
  - OFF: The Emergency frequency is skipped during the Distress scan.
- Push [MENU] or [Home] to return to the Main screen.

■ DSC Settings

◇ Scanning Receiver (Continued)

**When selecting or editing “Routine frequency”**

1. Open “Routine.”

[MENU] > Settings > DSC > Scanning Receiver > **Routine**

2. Select a channel.

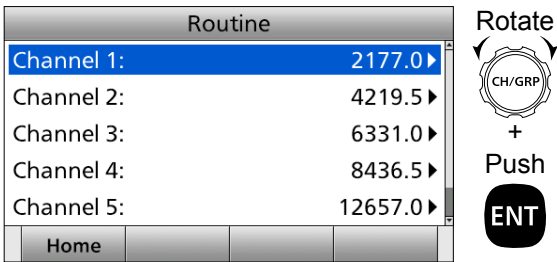

3. Enter a Routine frequency.  
After entering, select “Finish” and push [ENT].

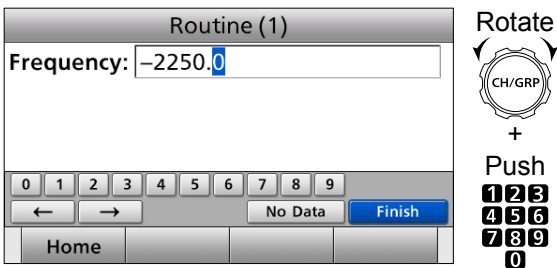

4. Push [MENU] or [Home]  to return to the Main screen.

◇ **Auto ACK**

[MENU] > Settings > DSC > **Auto ACK**

The Automatic Acknowledgment function automatically sends an Acknowledgment when an appropriate Request is received.

● **Individual ACK**

- Auto (Unable): Automatically sends “Unable to comply.”
- Manual: Manually sends an Acknowledgment.

● **Position ACK**

- Auto (Able): Automatically sends an Acknowledgment with the position and time data.
- Manual: Manually sends an Acknowledgment.

● **Polling ACK**

- Auto: Automatically sends an Acknowledgment with the position and time data.
- Manual: Manually sends an Acknowledgment.

● **Test ACK**

- Auto: Automatically sends an Acknowledgment.
- Manual: Manually sends an Acknowledgment.

◇ **Medical Transports**

[MENU] > Settings > DSC > **Medical Transports**

You can select whether or not the “Medical Transports” item is displayed in the Compose Non-Distress screen.

- ON: Displayed in the Compose Non-Distress screen.
- OFF: Not displayed in the Compose Non-Distress screen.

◇ **Ships and Aircraft**

[MENU] > Settings > DSC > **Ships and Aircraft**

You can select whether or not the “Ships and Aircraft” item is displayed in the Compose Non-Distress screen.

- ON: Displayed in the Compose Non-Distress screen.
- OFF: Not displayed in the Compose Non-Distress screen.

### ◇ CH Auto Switch

According to the regulation, after receiving a DSC call, the transceiver's operating channel is switched to the specified channel by the call.

1. Open "CH Auto Switch."  
[MENU] > Settings > DSC > **CH Auto Switch**
2. Select an option.
  - Accept after 10 sec.:  
After receiving a DSC call, the transceiver remains on the current operating channel for 10 seconds. After that, the transceiver automatically switches to the channel specified by the call.
  - Hold after 10 sec.:  
After receiving a DSC call, if Accept is not pushed within 10 seconds, the transceiver holds the call as a DSC task and remains on the current operating channel.
  - Manual:  
After receiving a DSC call, you can select whether or not to accept the received DSC call.
3. Push [MENU] or [Home]  to return to the Main screen.

### ◇ DSC Data Output

When receiving a DSC call from the station selected in this setting, the transceiver outputs the DSC data to the NMEA output port.

① You can send Distress calls regardless of this setting.

1. Open "DSC Data Output."  
[MENU] > Settings > DSC > **DSC Data Output**
2. Select an option.
  - All Stations: From any station.
  - Station List: From the stations entered in the Individual ID or Group ID setting
  - OFF: Does not output any DSC data from the NMEA Output port.
3. Push [MENU] or [Home]  to return to the Main screen.

### ◇ Alarm Status

Sets the alarm ON or OFF when receiving each type of DSC call.

#### ● Safety/Routine

[MENU] > Settings > DSC > Alarm Status > **Safety**

[MENU] > Settings > DSC > Alarm Status > **Routine**

Sets the alarm for when receiving the Safety or Routine DSC call.

#### ● Warning

[MENU] > Settings > DSC > Alarm Status > **Warning**

Sets the alarm for when:

- No MMSI code is entered.
- The position data has not been updated for 10 minutes.
- The position data has not been manually updated for 4 hours.
- The invalid GPS position data or manually entered position data has not updated for 23.5 hours.

#### ● Self-Terminate

[MENU] > Settings > DSC > Alarm Status > **Self-Terminate**

Sets the alarm for when receiving the same Distress call.

#### ● Discrete

[MENU] > Settings > DSC > Alarm Status > **Discrete**

Sets the alarm for when receiving a lower priority DSC call while receiving a higher priority call.

#### ● MAX Distance 2-Tone

[MENU] > Settings > DSC > Alarm Status > **MAX Distance 2-Tone**

Set the maximum distance between vessels for the ringing of the 2-tone alarm is enabled.

■ DSC Settings

◇ **Auto Print**

[MENU] > Settings > DSC > **Auto Print**

Select whether or not to enable the Automatic Print Out function when a DSC call is received. The received DSC call content is printed out if a printer is connected to the transceiver.

ON: The received DSC call contents is printed out.  
OFF: The received DSC call contents is not printed out.

◇ **Self Check Test**

[MENU] > Settings > DSC > **Self Check Test**

The Self Check Test function sends DSC signals to the receiving AF circuit to compare the sending and receiving signals at the AF level.

Push [ENT] to start the Self Check test.  
①When the sending and receiving signals match, "OK" is displayed.

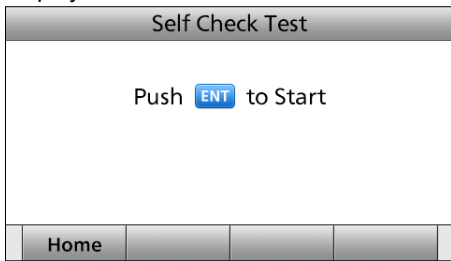

**NOTE:** If "Failed" is displayed, contact your dealer.



## About the Menu screen

The Menu screen is constructed in a tree structure and used to set items, select options, and so on for the transceiver's functions.

You can go to the next tree level by pushing [ENT], or [▶], and go back a level by pushing [CLR], or [◀].

① The displayed menu items may differ, depending on the transceiver version or presetting.

To select an item, rotate [CH/GRP], or push [▲] and [▼].

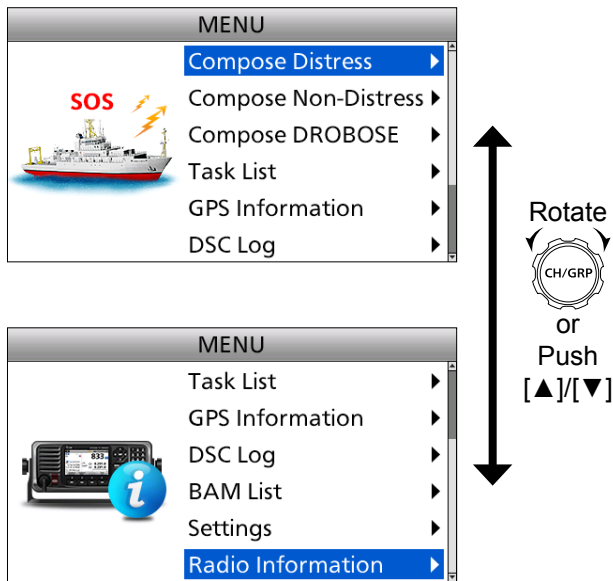

## Selecting the item

Follow the procedures described below to select a Menu screen.

Example: Turning ON the Voice Squelch function.

1. Open "Radio."

[MENU] > Settings > **Radio**

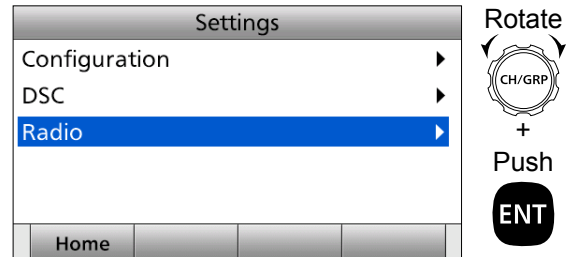

2. Select "Voice SQL."

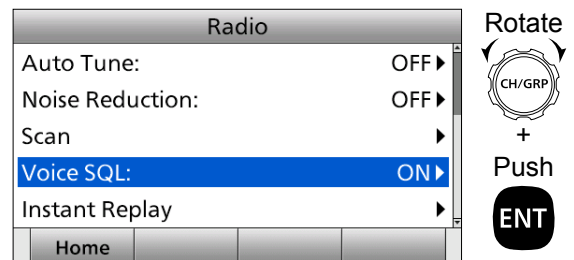

3. Select "ON."

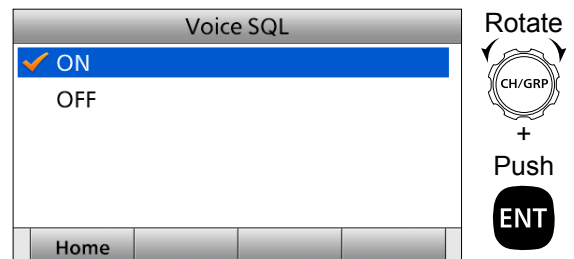

• Returns to the Radio Settings screen.

4. Push [MENU] to return to the Main screen.

## ■ Menu Construction

The Menu screen is constructed in a tree structure, and the following items are described in each section. Refer to the pages in the chart for details.

① The displayed menu items may differ, depending on the transceiver version or presetting.

<b>Compose Distress</b>	
Nature of Distress	p. 27
Position	p. 27
• Latitude	
• Longitude	
• UTC	
Mode	p. 22
Attempt	p. 27

<b>Compose Non-Distress</b>	
Message Type	p. 37
Address* <sup>1</sup>	p. 37
Area* <sup>1</sup>	p. 41
• Latitude* <sup>1</sup>	
• Longitude* <sup>1</sup>	
• Radius* <sup>1</sup>	
• Height* <sup>1</sup>	
• Width* <sup>1</sup>	
Category	p. 37
Call Frequency	p. 42
• RX Frequency	
• TX Frequency	
Mode* <sup>1</sup>	p. 22
Voice Frequency* <sup>1</sup>	p. 37
• RX Frequency* <sup>1</sup>	
• TX Frequency* <sup>1</sup>	

<b>Compose DROBOSE</b>	
Message Type	p. 32
Address	p. 32
Area* <sup>1</sup>	p. 48
• Latitude* <sup>1</sup>	
• Longitude* <sup>1</sup>	
• Radius* <sup>1</sup>	
• Height* <sup>1</sup>	
• Width* <sup>1</sup>	
Distress ID	p. 32
Nature of Distress	p. 33
Position	p. 33
• Latitude	
• Longitude	
• UTC	
Call Frequency	p. 33
• RX Frequency	
• TX Frequency	
Mode	p. 22
Voice Frequency	p. 37
• RX Frequency	
• TX Frequency	

<b>Task List</b>	<b>p. 25</b>
------------------	--------------

<b>GPS Information</b>	<b>p. 71</b>
------------------------	--------------

<b>DSC Log</b>	
Received Call Log	p. 62
• Distress	
• Others	
Transmitted Call Log	p. 62

<b>BAM List</b>	<b>p. 20</b>
-----------------	--------------

\*<sup>1</sup> These items may not be displayed, depending on the "Message Type" option.

<b>Settings</b>	
<b>Configuration</b>	
Display	p. 71
Backlight	
Day mode	
Night mode	
Mode	
Night Mode Time	
Current	
Start	
End	
Key Beep	p. 72
Key Assignment	p. 72
• Softkey Assignment	
• Volume Dial Assignment	
• P Key Assignment	
MIC Key Lock	p. 72
UTC Offset	p. 72
Inactivity Timer	p. 72
• Not DSC Related	
• DSC Related	
• Distress Related	
• RT Related-J3E/H3E/LSB/J2B/F1B/A1A	
Position Data Output	p. 72
BAM	p. 72
• Function	
<b>DSC</b>	
Position Input*2	p. 24
Individual ID	p. 22
Group ID	p. 22
DSC Frequency	p. 63
Scanning Receiver	p. 64
• Distress	
• Routine	
Auto ACK	p. 65
• Individual ACK	
• Position ACK	
• Polling ACK	
• Test ACK	
Medical Transports	p. 65
Ships and Aircraft	p. 65
CH Auto Switch	p. 66
DSC Data Output	p. 66

Alarm Status*3	p. 66
• Safety	
• Routine	
• Warning	
• Self-Terminate	
• Discrete	
• MAX Distance 2-Tone	
Auto Print	p. 67
Self Check Test	p. 67

<b>Radio</b>	
User Channel	p. 15
MAX User Channel	p. 15
ITU Simplex Channel	p. 73
Auto Tune	p. 73
Noise Reduction	p. 73
Scan	p. 73
Type	
Speed	
Program Scan Frequency	
Start Frequency	
End Frequency	
Voice SQL	p. 73
Instant Replay	p. 73
Function	
Recording Time	
Play Time	

\*2 This item is not displayed when valid GPS data is received.  
 \*3 This item is not displayed when the BAM function is turned ON. (p. 72)

<b>Radio Information</b>	<b>p. 73</b>
--------------------------	--------------

## ■ GPS Information

Displays your position, time, Speed Over Ground (SOG), and Course Over Ground (COG) using the external GPS receiver data.

## ■ Configuration

### ◇ Display

#### ● Backlight

[MENU] > Settings > Configuration > Display > **Backlight**

You can adjust the backlight brightness level of the Day mode and the Night mode displays.

#### Day mode

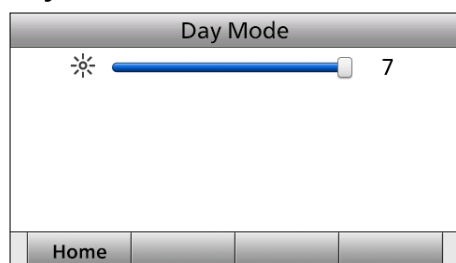

#### Night mode

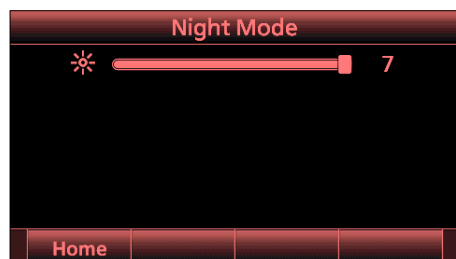

#### ● Mode

[MENU] > Settings > Configuration > Display > **Mode**

Set the LCD backlight mode.

- Day mode: The screen is displayed in the Day mode.
- Night mode: The screen is displayed in the Night mode.
- Auto: The Day mode or the Night mode is automatically selected.

#### ● Night Mode Time

[MENU] > Settings > Configuration > Display > **Night Mode Time**

Sets the period of time that the Backlight mode is automatically set to Night Mode when the “Mode” item is set to “Auto.”

- Current: Enters the current time (if it is incorrect.)
  - ① The current time is displayed when valid GPS data is received, or your UTC time is manually entered in the “Position Input.” (p. 24)
- Start: Enters the time that Night Mode starts.
- End: Enters the time that Night Mode ends.

1. Enter the current time (if it is incorrect.)  
After entering, select “Next” and push [ENT].

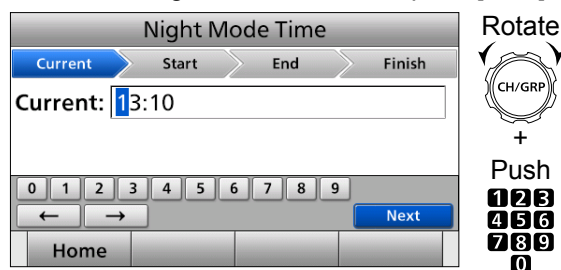

2. Enter the start time and the end time.

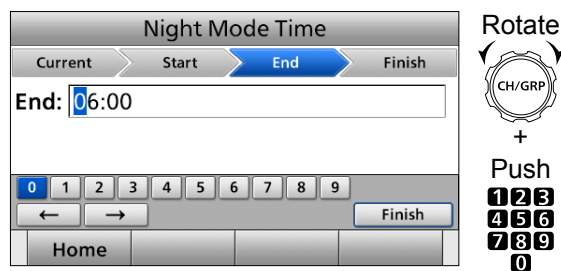
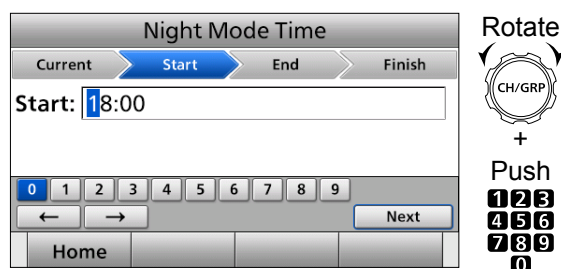

3. After entering, select “Finish” and push [ENT].
  - Returns to the previous screen.

### ◇ Key Beep

[MENU] > Settings > Configuration > **Key Beep**

Turn the Key Beep function ON or OFF.

- ON: When you push a key, a beep sounds.
- OFF: Turns OFF the function for silent operation.

### ◇ Key Assignment

[MENU] > Settings > Configuration > **Key Assignment**

You can assign some functions to the Software Keys, Volume dial, and [P] on the optional HM-214 to create convenient shortcuts. See page 16 about how to assign.

### ◇ MIC Key Lock

[MENU] > Settings > Configuration > **MIC Key Lock**

Turn the Microphone Key Lock function ON or OFF.

- ON: You can use the keys on the optional HM-214H MICROPHONE ([P], [UP], [DOWN] and [D-Scan]).
- OFF: You cannot use the keys on the optional HM-214H microphone.

### ◇ UTC Offset

[MENU] > Settings > Configuration > **UTC Offset**

Set the offset time between Universal Time Coordinated (UTC) and your local time to between -14:00 and +14:00 (in 1 minute steps).

### ◇ Inactivity Timer

[MENU] > Settings > Configuration > **Inactivity Timer**

The transceiver automatically returns to the Main screen if you push no key for each mode's set period of time.

The countdown alarm sounds 10 seconds before the Inactivity Timer activates.

#### For Not DSC Related, DSC Related, and Distress Related:

Set the Inactivity Timer to between 1 and 15 minutes (in 1 minute steps), or OFF.

#### ● Not DSC Related

[MENU] > Settings > Configuration > Inactivity Timer > **Not DSC Related**

Setting for when a screen that is not related to DSC is displayed.

#### ● DSC Related

[MENU] > Settings > Configuration > Inactivity Timer > **DSC Related**

Setting for when a screen that is related to DSC is displayed.

#### ● Distress Related

[MENU] > Settings > Configuration > Inactivity Timer > **Distress Related**

Setting for when a screen that is related to a Distress call is displayed.

#### For RT Related (J3E/H3E/LSB/J2B/F1B/A1A):

Set the inactivity timer 10 sec, 30 sec, between 1 and 10 min (in 1 minute steps), or OFF.

#### ● RT Related (J3E/H3E/LSB/J2B/F1B/A1A)

[MENU] > Settings > Configuration > Inactivity Timer > **RT Related-J3E/H3E/LSB/J2B/F1B/A1A**

Setting for when the transceiver is in the Radio Telephone mode.

### ◇ Position Data Output

[MENU] > Settings > Configuration > **Position Data Output**

Select whether or not to output the NMEA sentences (DSC and DSE) from the NMEA 0183 output port to an external device when receiving a DSC call.

- ON: Outputs the NMEA sentences.
- OFF: Does not output the NMEA sentences.

### ◇ BAM

Set the BAM function.

#### ● Function

[MENU] > Settings > Configuration > BAM > **Function**

Turn the Bridge Alert Management (BAM) function ON or OFF. (p. 18)

When this function is OFF:

- The alerts related to the BAM function cannot be received.
- The BAM List is not displayed in the Menu screen.

## ■ Radio Settings

- ◇ User Channel (p. 15)
- ◇ ITU Simplex Channel (p. 15)

### ◇ MAX User Channel

[MENU] > Settings > Radio > **MAX User Channel**

Set the number of maximum User channels to between 1 and 160.

### ◇ Auto Tune

[MENU] > Settings > Radio > **Auto Tune**

Turn the Auto Tune function ON or OFF. When this function is ON, tuning is automatically started when an optional antenna tuner is connected and the frequency is changed.

- ON: When the AT-141 is connected, tuning is automatically started.
- OFF: When the operating frequency is changed, tuning by pushing [TUNE] is needed.

### ◇ Noise Reduction

[MENU] > Settings > Radio > **Noise Reduction**

Set the Noise Reduction level to between 1 and 15, or OFF.

### ◇ Scan

#### ● Type

[MENU] > Settings > Radio > Scan > **Type**

Select a scan type to locate signals.

① See pages 12 for details.

- Channel/Channel Resume: The Channel and Channel Resume searches within a 20 channel range, such as channel 1 to channel 20, in the user channels, and searches all channels in the same bandwidth in the ITU channels
- Program: The Program scan searches the signals within the frequency range. Searches slower When the squelch is open, and searches faster when squelch is closed.

#### ● Speed

[MENU] > Settings > Radio > Scan > **Speed**

Set the scanning speed (the rate at which channels are searched) to between 1 (fast) and 10 (slow).

#### ● Program Scan Frequency

[MENU] > Settings > Radio > Scan > **Program Scan Frequency**

Set the Start Frequency and the End Frequency used for the Program scan.

### ◇ Voice SQL

[MENU] > Settings > Radio > **Voice SQL**

Turn the Voice Squelch function ON or OFF when operating in the J3E and H3E modes.

When this function is turned OFF, the squelch operates as an S-meter squelch in the J3E and H3E modes.

### ◇ Instant Replay

#### ● Function

[MENU] > Settings > Radio > Instant Replay > **Function**

Turn the Instant Replay function ON or OFF. This function enables you to record the received audio and replay it.

#### ● Recording Time

[MENU] > Settings > Radio > Instant Replay > **Recording Time**

The maximum recordable time is permanently set to 120 seconds.

#### ● Play Time

[MENU] > Settings > Radio > Instant Replay > **Play Time**

Set the play start point of the recorded audio to between 5 and 120 seconds (in 5 second steps). When [RX Play]  is pushed, playback will start from the position rewound for the set time from the recording time.

## ■ Radio information

[MENU] > **Radio Information**

Displays your transceiver's information.

Radio Information			
MMSI:	123456789		
Serial No.:			
Main:			
Sub:			
FPGA:			
Home			

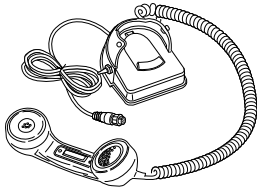

Handset

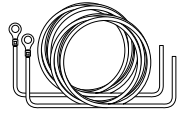

DC power cable  
(Red and Black)



RCA cable  
(for the GPS connection)

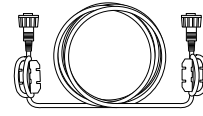

Remote control cable



Weatherproof caps



Tuner connector kit

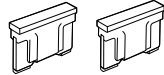

Spare fuses  
(REG-DC-A 5 A,  
PA-A 5 A)



Ferrite EMI filter  
(for the DC power cable)

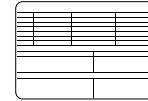

Emergency frequency sticker

## Mounting plates kit for the Main unit

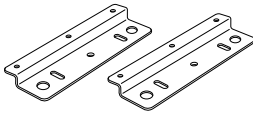

Mounting plates

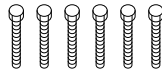

Hex head bolts  
(M6x50)



Hex head bolts  
(M6x15)



Spring washers (M6)



Flat washers (M6)



Hex nuts (M6)



Rubber feet

## Mounting bracket kit for the remote controller

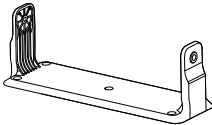

Mounting bracket

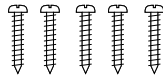

Self-tapping screws (M5)



Flat washers (M5)



Spring washers (M5)

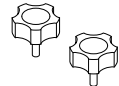

Knobs

**NOTE:** Some accessories may not be supplied, or the shape may be different, depending on the transceiver version.

## ■ Connections

**CAUTION:**

- After connecting an antenna, tuner control cables, external speaker, or GPS receiver, cover the connectors with rubber vulcanizing tape, as shown below. Covering with the tape prevents water from seeping into the connector.
- **DO NOT** pull the antenna and control cable receptacles. It may cause cable disconnection (in the tuner unit), damage inside the connector, or a bad connection.

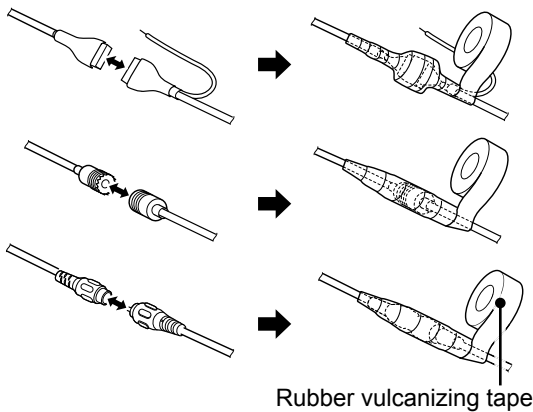

**NOTE:**

Turn OFF [DC ISOLATE] on the GM800 main unit, or charge the battery while at anchor, otherwise the battery may become exhausted. The GM800 has a high-stability oven heater-type crystal oscillator, and the oscillator's heater is directly connected to the DC power terminals. It keeps its temperature at a specified level, even if you turn OFF the power by holding down [⏻] on the remote controller.

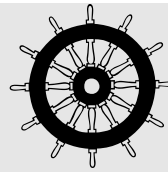

**GM800**

**NOTE:** Must be used with the ICOM AT-141.

◇ Basic connections

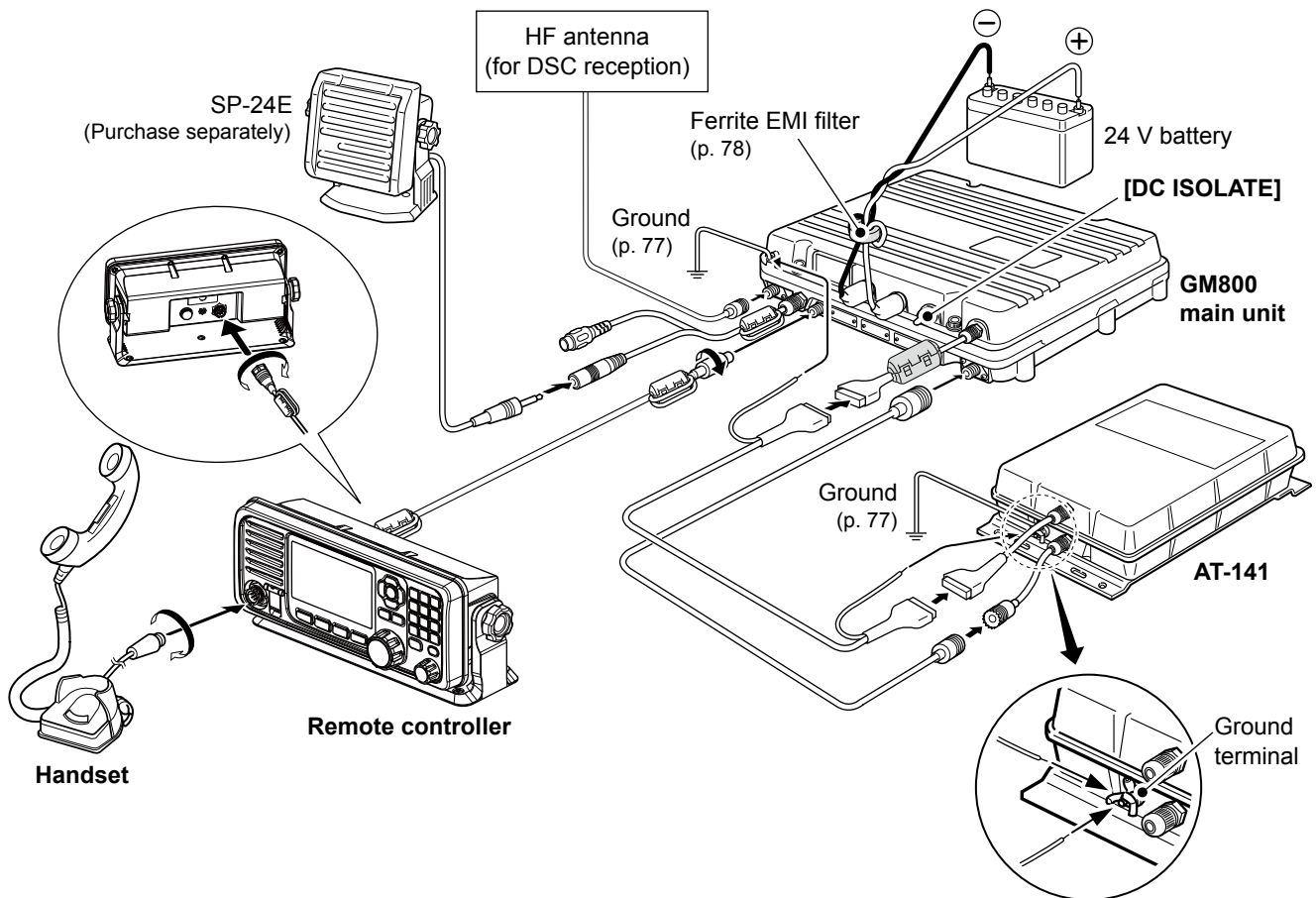



### ◆ Advanced connections

**TIP:** When both a PC and the remote controller are connected

- The PC being operated has priority over the remote controller at any given time.
- The remote controller cannot be operated.
- The PC being operated automatically updates the settings of the remote controller.

**NOTE for a remote controller:**

If the initial connection does not work, try reversing the wire connections. The RS-232C's pin assignments may differ, depending on the manufacturer. See pages 83 and 84 for connector information details.

**NOTE:** When using the AF/MOD, REMOTE, or PRINTER connector, detach the cover or cap.

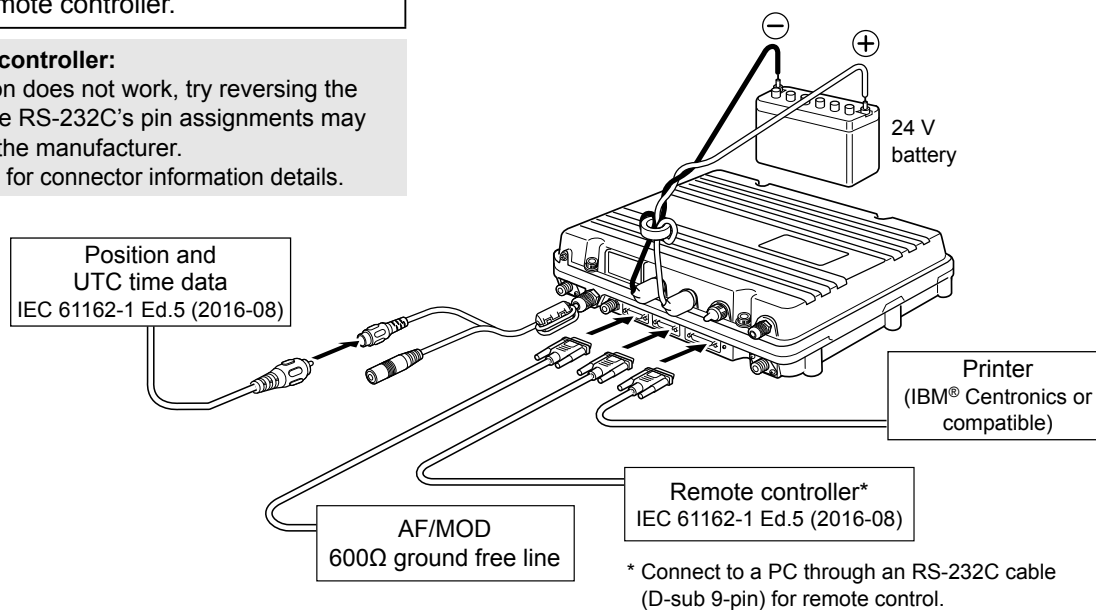

### ◆ Connecting the microphone

1. Insert the microphone's connector into the microphone jack on the remote controller's front panel.
2. Rotate the connector clockwise until it is completely tightened.

**CAUTION:**

- **BE SURE** that the microphone's connector is completely screwed in. Otherwise, the remote controller may lose its waterproof protection.
- **DO NOT** use non-Icom microphones. Other manufacturer's microphones have different pin assignments, and a connection to the remote controller may damage it.

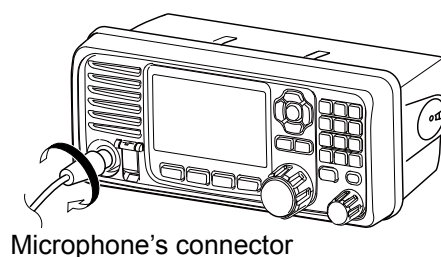

### ◆ Connecting the remote control cable

1. Insert the remote control cable's connector into the main unit jack on the remote controller's back panel.
2. Rotate the connector clockwise until it is completely tightened.

**CAUTION: BE SURE** that the control cable's connector is completely screwed to the remote controller's back panel. Otherwise, the remote controller may lose its waterproof protection.

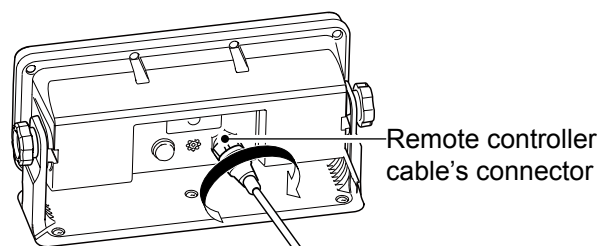

## Ground connection

The transceiver and antenna tuner must have a proper RF ground connection. Otherwise, the efficiency of the transceiver and antenna tuner may be reduced. Also, electrolysis, electrical shocks, and interference with other equipment may occur. For the best results, use a 50 or 75 mm wide copper strap, and connect as short as possible. Ground the transceiver and antenna tuner to one ground point. Otherwise, the voltage difference (at the RF level) between the 2 ground points may cause electrolysis.

**⚠ WARNING!** When grounding to a metal hull, use Zinc anodes to protect the hull from electrolysis. Ask your dealer or installer for RF grounding details.

**CAUTION:**

- **DO NOT** connect the transceiver to a “positive grounded vessel.” Otherwise, the transceiver will not function.
- Any external units, such as PC, printer and so on, must be properly grounded. We suggest using a wide copper strap.

**Best ground points and materials**

- External ground plate
- Copper screen
- Copper foil

**Acceptable ground points**

- Stainless steel stanchion
- Through mast
- Through hull
- Metal water tank

**Undesirable ground points**

- Engine block
- Vessel’s DC battery ground

**Unusable ground points**

- (These connections may cause an explosion or electrical shock)
- Gas or electrical pipe
  - Fuel tank or oil catch pan

**Ground system example**

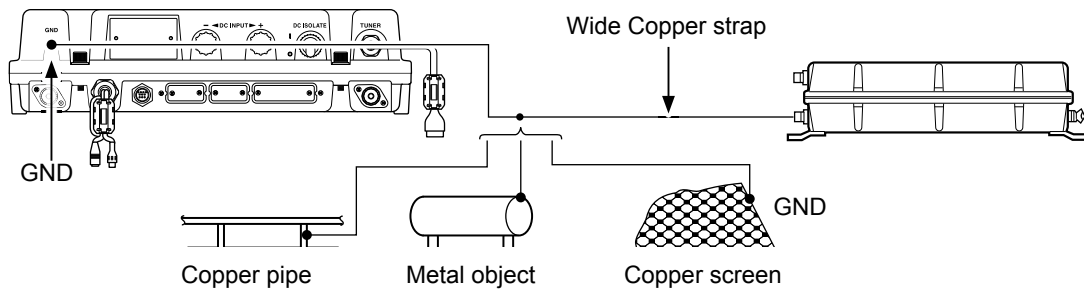

## Software maintenance

The Icom customer support center provides the firmware file for transceiver maintenance. You can update the transceiver’s firmware through a PC.

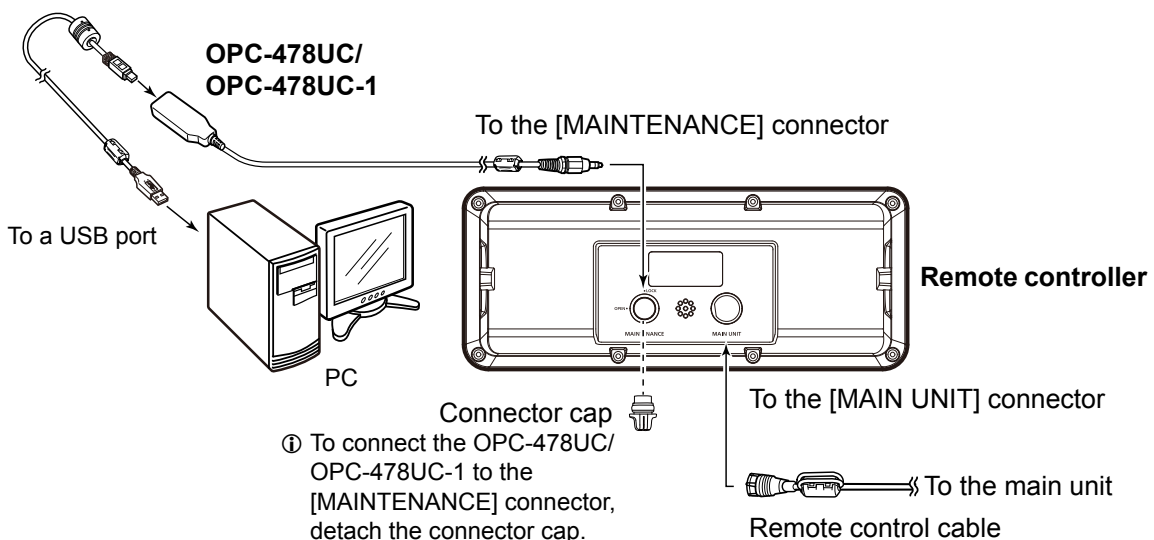

## Power source

The transceiver requires a regulated DC power of 26.4 V and at least 30 A. Directly connect to a 24 V battery in your vessel through the supplied DC power cable.

**CAUTION:**

- **DO NOT** reverse the DC power cable polarity. This could damage the transceiver.
- **BE SURE** to use a 24 V battery, depending on the transceiver version.

### DC power cable connection

**NOTE:** Use terminals for the cable connection.

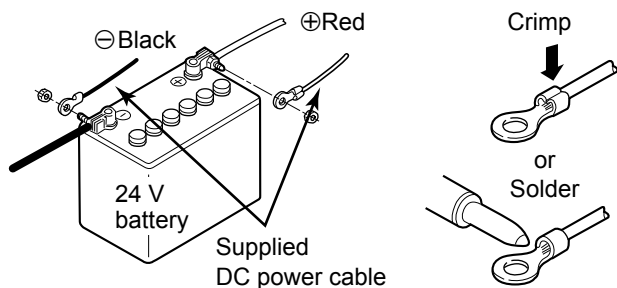

### Attaching the weatherproof cap

Attach the supplied weatherproof cap for each positive and negative line at the DC power terminal, as shown below.

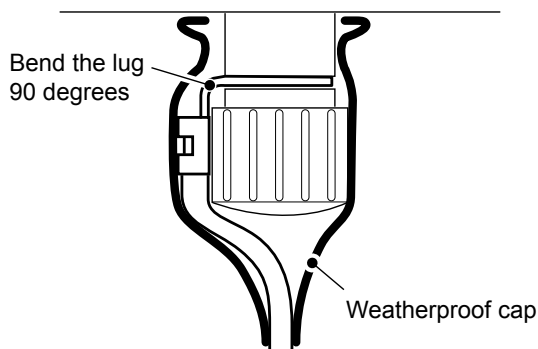

### Attaching the Ferrite EMI filter

Connect the DC power cables to the transceiver's main unit through the supplied Ferrite EMI filter, as shown below.

**NOTE:** Place the Ferrite EMI filter as close to the main unit as possible.

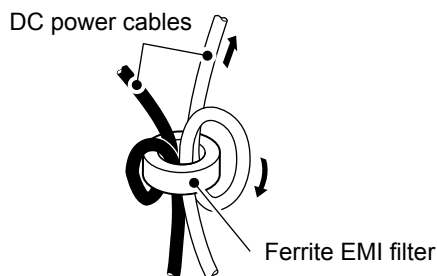

## Antenna

Most stations operate with a whip or long wire antenna. However, these antennas cannot be connected directly to the transceiver because their impedance may not match the transceiver antenna connector. Use the AT-141 to connect antennas.

For details about antenna connections and installation, see the supplied AT-141 Instruction manual.

**⚠ DANGER! HIGH VOLTAGE! NEVER** touch an antenna while transmitting. It may result in an electrical shock or burn.

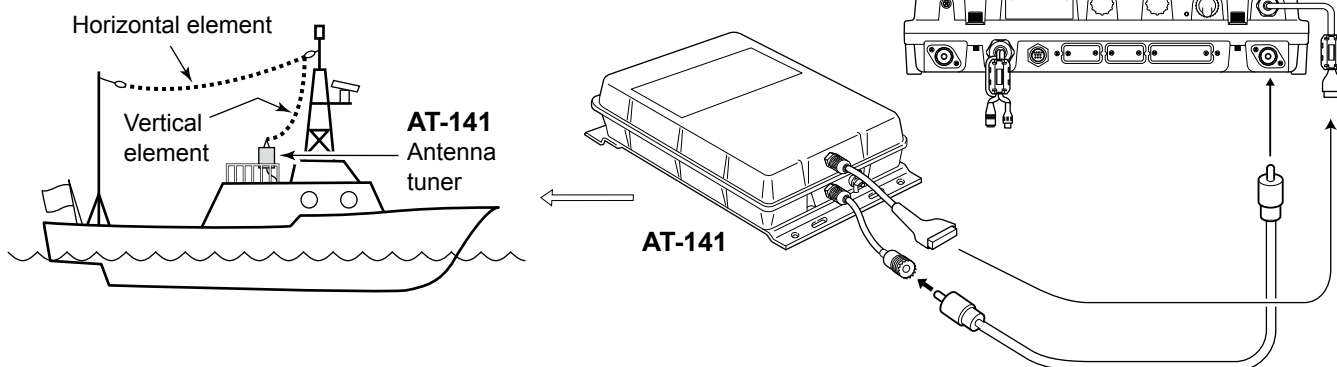

## ■ Mounting

### ◇ Mounting location

Select a location that provides easy access to the remote controller for navigation safety, has good ventilation and is not exposed to sea spray. The remote controller should be in your line of sight when operating it.

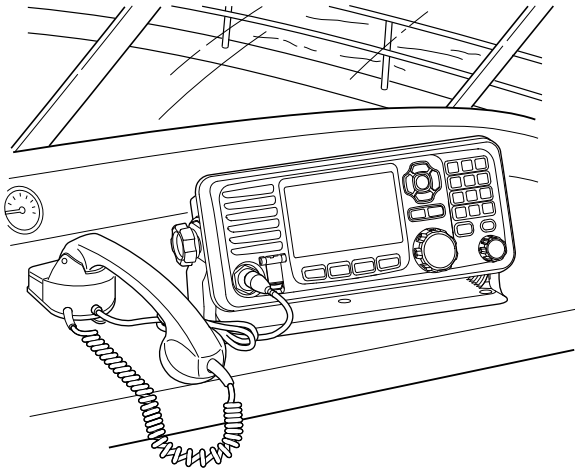

### ◇ Mounting the remote controller

You can mount the remote controller on a dashboard using the mounting bracket supplied with the transceiver.

1. Securely mount the bracket to a more than 10 mm thick surface that supports more than 2 kg, using the 5 supplied screws (5 × 20 mm).
2. Attach the remote controller to the bracket so that the face of the remote controller is in your line of sight when operating it.  
① Adjust the function display angle to be easy to read.
3. Attach the supplied knobs to both sides of the remote controller.

**CAUTION: KEEP** the transceiver and microphone at least 1 meter away from your vessel's magnetic navigation compass.

**CAUTION:**

- Turn OFF [DC ISOLATE] on the Main unit when mounting the transceiver.
- Place the supplied Emergency frequency sticker to where it always be visible when operating the transceiver.

■ Emergency frequency list			
	Radiotelephone(User CH)	DSC(Digital Selective Calling)	Radiotelex
MF	2182kHz (CH 1)	2187.5kHz	2174.5kHz
HF4	4125kHz (CH 2)	4207.5kHz	4177.5kHz
HF6	6215kHz (CH 3)	6312.0kHz	6268.0kHz
HF8	8291kHz (CH 4)	8414.5kHz	8376.5kHz
HF12	12290kHz (CH 5)	12577.0kHz	12520.0kHz
HF16	16420kHz (CH 6)	16804.5kHz	16695.0kHz

  

■ Emergency operation	
Sending a Distress call	Sending a Distress Cancel call
1. Lift up the key cover of [DISTRESS]. 2. Hold down [DISTRESS] for 3 seconds to send the Distress call.	1. When "Waiting for Distress ACK" is displayed, push [Cancel]. 2. Push [Continue] to send the Distress Cancel call.

■ DSC call operation	
1. Push [Compose Distress], [Compose Other] or [Compose DPOB05E] and enter the required information. 2. Push [Call] to transmit a DSC call.	

### Mounting Example

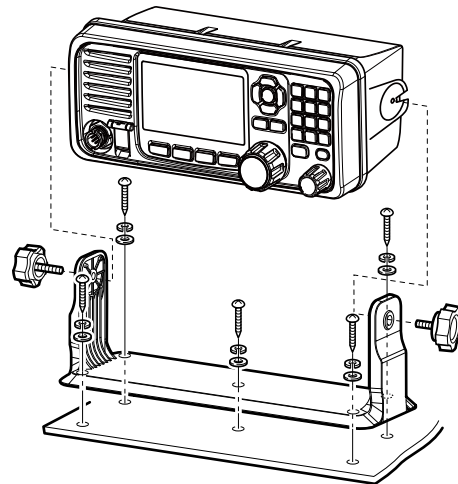

### ◇ Mounting the main unit

You can mount the Main unit using the supplied mounting plates.

**⚠ WARNING! NEVER** mount the transceiver's Main unit overhead. The weight of the Main unit is approximately 8.7 kg, and it could easily fall due to wave shocks or vibration. The unit must be mounted on a flat hard surface only.

1. Attach the supplied rubbers feet to the mounting plates, if necessary.

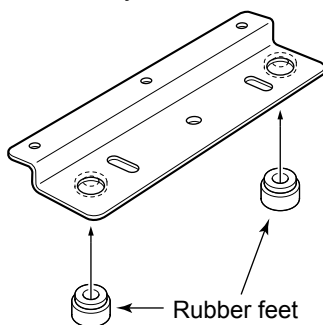

2. Attach the mounting plates to the Main unit using the 6 supplied hex head bolts (6 × 15 mm), 6 flat and spring washers, as shown below.

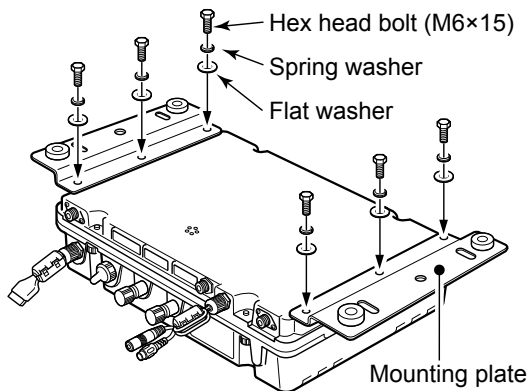

3. Securely mount the Main unit to a surface, which is less than 25 mm thick and can support more than 15 kg.
4. Attach the 6 supplied hex head bolts (6 × 50 mm), 12 flat and spring washers, and 6 nuts, as shown below. (Torque: 3 N•m)

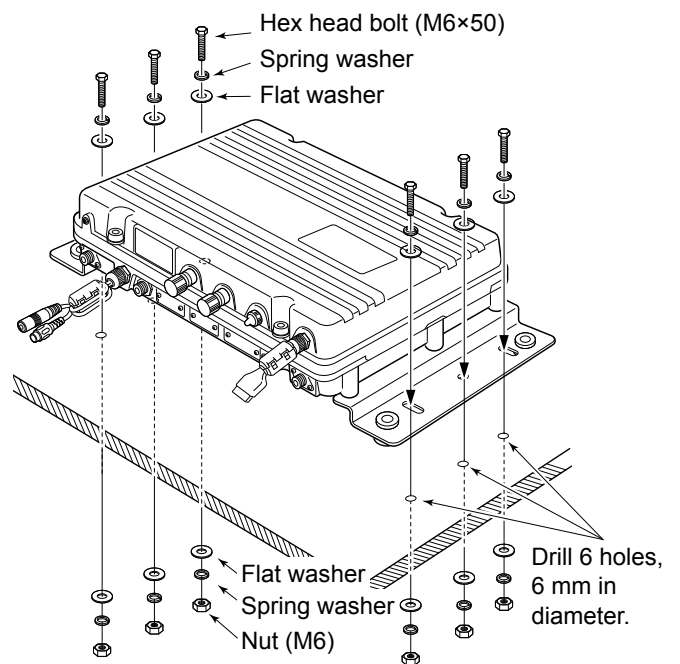

## ■ MB-108 installation

The optional MB-108 mounting bracket is for mounting the Main unit to a flat surface (less than 25 mm thick and can support more than 15 kg), such as an instrument panel.

The MB-108 provides a one-touch attachment or detachment.

1. Attach the mounting handles with the 6 supplied hex head bolts (6 × 15 mm), 6 spring and flat washers, as shown below.

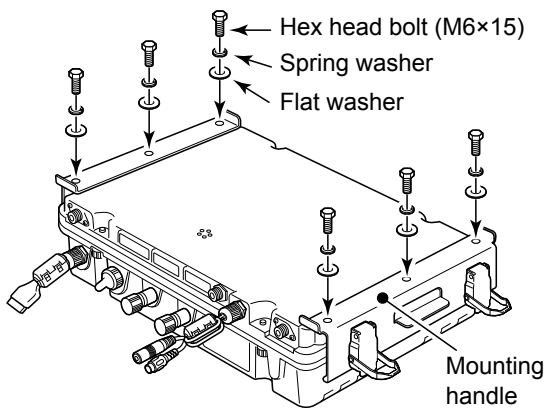

2. Drill 7 holes, 6 ~ 8 mm in diameter, using the template supplied with the MB-108.
3. Attach the mounting base to a flat surface using the 7 hex head bolts (6 × 50 mm), 14 spring and flat washers, and 7 nuts supplied with the MB-108, as shown below. (Torque: 3 N·m)

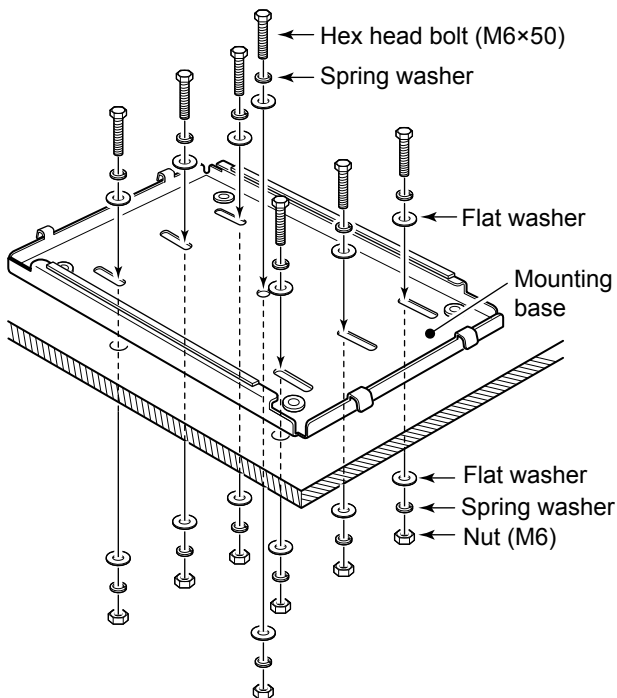

### CAUTION:

- **KEEP** the transceiver and microphone at least 1 meter away from your vessel's magnetic navigation compass.
- Wear gloves when installing the MB-108. The edges of the MB-108 may be sharp and may cut your fingers or hands.

4. Mount the Main unit with the mounting handles attached to the mounting base.

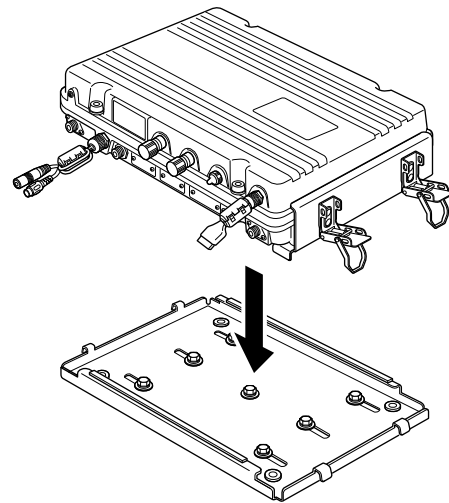

5. Lock the Main unit in place by closing the 4 latches on the mounting handles.

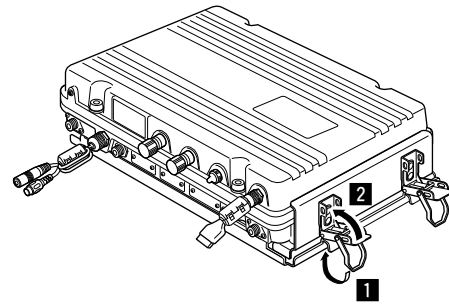

## ■ Replacing fuses

The transceiver has 2 fuses to protect internal circuitry.

If the transceiver stops functioning, and only after confirming a fuse is probably blown, check the fuses below.

- DC-DC converter unit: REG-DC-A 5 A
- PA unit: PA-A 5 A

1. Unscrew the 4 cap bolts from the top case with a 6 mm Allen wrench.

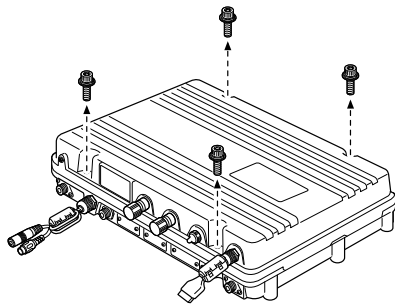

2. Open the Main unit, and then disconnect 1 flat and 2 coaxial cables, as shown below.

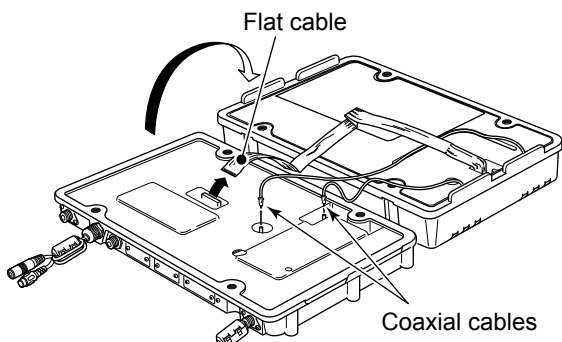

3. Unscrew the 26 screws from the shield covers, and then open the covers.

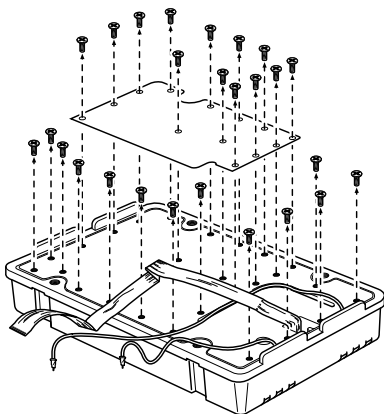

**CAUTION:** Disconnect the DC power cable from the transceiver before replacing a fuse.

4. Replace the circuitry fuses, as shown below.

Fuse in DC-DC converter unit

Fuse in PA unit

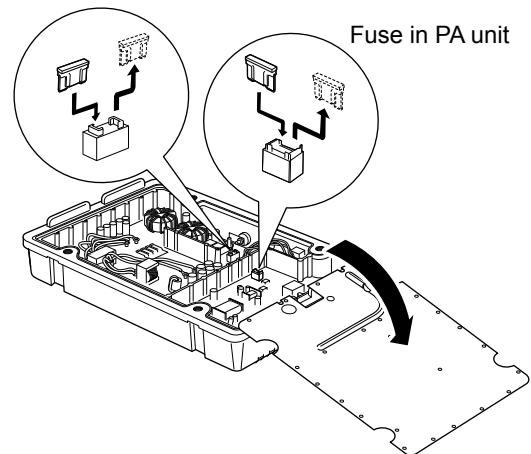

**CAUTION:** When removing a fuse, use longnose pliers to protect your fingers and the fuse holders.

5. Replace the shield covers, flat cable, coaxial cables, and top case to their original locations.

## ■ Connector information

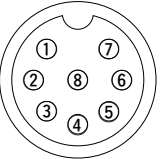
MICROPHONE	Pin	Pin name	Description	Specification
 <p>Front panel view</p>	1	MIC (+)	Audio input from the mic element.	Input impedance: 2.4 kΩ
	2	MIC SW	Key detection.	—
	3	AF1	AF output controlled by [VOL].	—
	4	AF2	Ground for AF1.	—
	5	PTT	PTT switch input. Transmits when grounded.	—
	6	GND	Connected to ground.	—
	7	MIC (-)	Coaxial ground for MIC (+).	—
	8	AF (-)	Coaxial ground for AF1 and AF2.	—

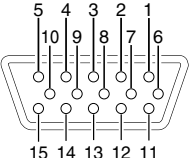
AF/MOD	Pin	Pin name	Description	Specification
 <p>Front panel view</p>	1~4	NC	<b>NOTE:</b> Do not connect to these pins.	—
	5	DSSW	Remote alarm input When connected to GND, the transceiver sends a Distress call. Can be used as an external Distress switch.	—
	6, 7	NC	<b>NOTE:</b> Do not connect to these pins.	—
	8	DSL D	Remote alarm output Connect external equipment such as a lamp or buzzer that needs a power source, between this pin and GND. When receiving a Distress call*, the key backlight blinks and the internal relay intermittently connects between this pin and GND.	Applicable voltage: Less than 30 V Current flow: Less than 1 A
	9, 10	GND	Ground	—
	11	MOD (+)	Modulation input from an external unit for the SSB.	Input impedance: 600 Ω Input level: Approximately 0.77 V rms
	12	MOD (-)	Coaxial ground for MOD (+).	Input impedance: 600 Ω
	13	AF (+)	AF detector output for an external unit for SSB.	Output impedance: 600 Ω Output level: 0.25 ~ 2.5 V rms
	14	AF (-)	Coaxial ground for AF (+).	Output impedance: 600 Ω
	15	SEND	Transmission control line for an external unit for SSB (transmits when grounded).	Output level: -0.5 ~ 0.8 V Input level: Less than 20 mA

\* A DSC call that is related to "Distress" as described below

- Distress call
- Distress Acknowledgment
- Distress Relay call
- Distress Relay Acknowledgment
- Distress Cancel call
- DSC call whose category is "Distress"

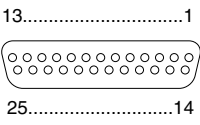

PRINTER	Pin	Pin name	Description
	1	STROBE	Outputs a strobe pulse after data output.
	2~9	DATA1~8	Outputs 8 bit parallel data.
	10	ACKNLG	Receives a 'Low' pulse from the printer when the printer can accept more data.
	11	BUSY	The printer sets this pin to 'High' when it can not accept data, such as when the printer is 'off line.'
	12~14	NC	<b>NOTE:</b> Do not connect to these pins.
	15	ERROR	The printer sets this pin to 'Low' when an error occurs, such as when the printer has no paper.
	16~17	NC	<b>NOTE:</b> Do not connect to these pins.
	18~25	GND	Ground terminals.

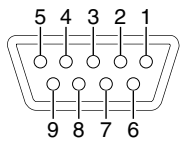
REMOTE	Pin	Pin name	Description	Specification
	1	DATA-OUT (-)	Ground for DATA-OUT (+) terminal.	-
	2	DATA-OUT (+)	IEC 61162-1 Ed.5 (2016-08) data output.	Input level: 5V, 40mA maximum (at 2 V applied)
	3	DATA-IN (+)	IEC 61162-1 Ed.5 (2016-08) data input.	Output level: Less than 2 mA (RS-232C balanced type)
	4	DATA-IN (-)	Ground for DATA-IN (+) terminal.	-
	5	GND	Connected to ground.	-
	6~9	NC	<b>NOTE:</b> Do not connect to these pins.	-

## ■ Transceiver dimensions

Unit: mm

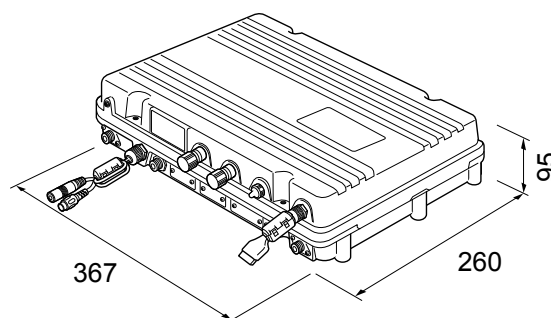
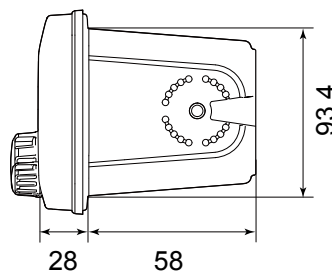
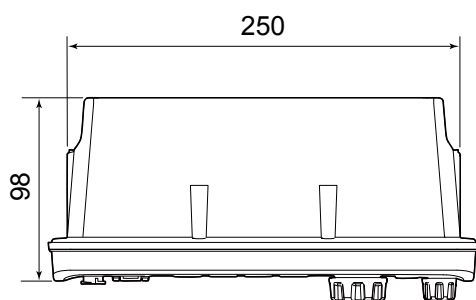
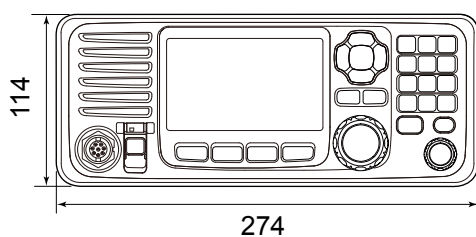

## ■ Specifications

### ◇ General

- Frequency coverage:
 

RX	0.5 ~ 29.9999 MHz (Continuously)
TX	1.6 ~ 2.9999 MHz, 4.0 ~ 4.9999 MHz,
	6.0 ~ 6.9999 MHz, 8.0 ~ 8.9999 MHz,
	12.0 ~ 13.9999 MHz, 16.0 ~ 17.9999 MHz,
	18.0 ~ 19.9999 MHz, 22.0 ~ 22.9999 MHz,
	25.0 ~ 27.5000 MHz
- DSC(RX)
 

	2.1875 MHz, 4.2075 MHz, 6.3120 MHz,
	8.4145 MHz, 12.5770 MHz, 16.8045 MHz
- Mode:
 

RX/TX	J3E (USB), F1B (FSK)
RX only	J3E (LSB), J2B (AFSK), A1A (CW), H3E (AM)
- Antenna impedance:
 

	50 Ω (unbalanced)
--	-------------------
- Frequency stability:
 

	±10 Hz (after 30 minutes from turning ON the main power)
--	--
- Power supply requirement:
 

	21.6 ~ 31.2 V (24 V DC)
--	-------------------------
- Current drain (with 1.1 kHz and 1.7 kHz AF input):
 

RX	Less than 3 A (24 V) at Maximum audio output
TX	Less than 20 A (24 V) at Maximum output power
- Usable temperature range:
 

	-15 ~ +55°C
--	-------------
- Dimension (projections not included):
 

Main unit	367 (W) × 95 (H) × 260 (D) mm
Controller	274 (W) × 114 (H) × 86 (D) mm
- Weight:
 

Main unit	8.7 kg
Controller	760 g
- BAM function type: P

### ◇ Transmitter

- Output power (Tuner output):
 

At radio terminal	150 W PEP into 50 Ω
At tuner output	1.6 ~ 3.9999 MHz 85 W PEP
	4.0 ~ 27.5000 MHz 125 W PEP
- Spurious emissions (at Maximum power):
 

	50 dB below peak output power
--	-------------------------------
- Carrier suppression (at Maximum power):
 

	40 dB below peak output power
--	-------------------------------
- Unwanted sideband suppression(at Maximum power):
 

	55 dB below peak output power
--	-------------------------------

### ◇ Receiver

- Sensitivity:
 

RX	
J3E, A1A	
0.5 ~ 1.5999 MHz	30 dBuV emf (20dB SINAD)
1.6 ~ 29.9999 MHz	8 dBμV emf (20 dB SINAD)
J2B, F1B	
0.5 ~ 1.5999 MHz	44 dBuV emf (20dB SINAD)
1.6 ~ 29.9999 MHz	-6 dBμV emf (1% error rate)
H3E	
1.6 ~ 3.9999 MHz	24 dBμV emf (20 dB SINAD)
DSC	
J2B	-6 dBμV emf (1% error rate)
- Squelch sensitivity (S-meter):
 

J3E (at 12.230 MHz)	
	Less than +26 dBμV emf (Threshold)
	Less than +96 dBμV emf (Tight)
H3E (at 1.000 MHz)	
	Less than +36 dBμV emf (Threshold)
	Less than +116 dBμV emf (Tight)
- Spurious response rejection:
 

J3E	More than 70 dB (1.6 ~ 29.9999 MHz)
J2B	More than 90 dBμV emf
- Clarity variable range: ±150 Hz

**NOTE:** The usable temperature range of the antenna tuner AT-141 is different from the GM800. The range is -20 ~ +55°C.

## Options

The following items are sold as a set with the GM800.

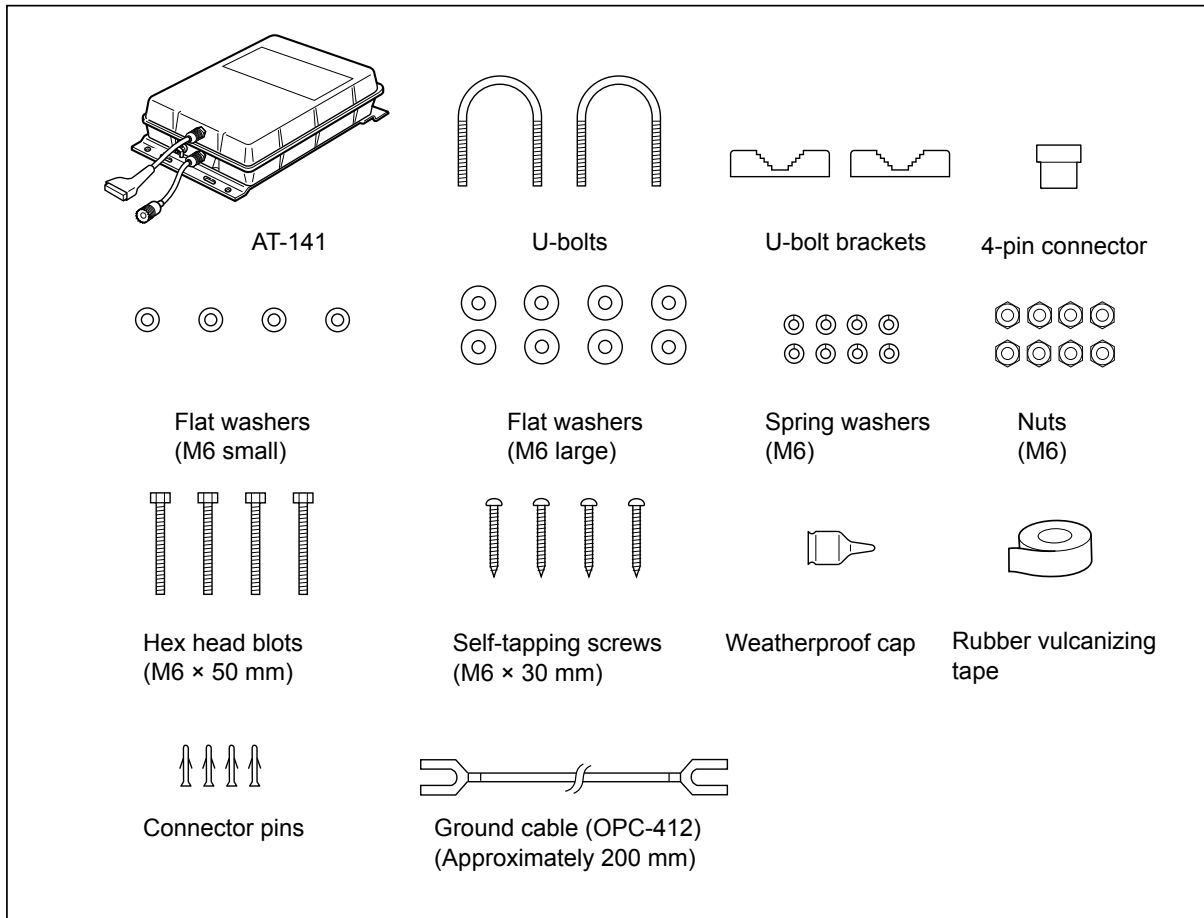

### ◇ Antenna Tuner

- **AT-141** AUTOMATIC ANTENNA TUNER  
Matches the transceiver to a long wire antenna with little insertion loss.

### ◇ Microphone

- **HM-214H** MICROPHONE  
IPX8 waterproof, dynamic microphone.

### ◇ Others

- **SP-24E** EXTERNAL SPEAKER  
4×4 inch external speaker.  
Input impedance: 4 Ω. Maximum input power: 7 W.
- **HS-98** HANDSET
- **OPC-1465** SHIELDED CONTROL CABLE  
10 meters shielded control cable connects the AT-141 to the transceiver.
- **MB-108** MOUNTING BRACKET  
To mount the Main unit.
- **CS-GM800 #11** PROGRAMMING SOFTWARE
- **OPC-478UC** PROGRAMMING CABLE
- **OPC-478UC-1** PROGRAMMING CABLE

## **The transceiver does not turn ON.**

- There is a bad connection to the power supply.  
→Check the connection between the transceiver and the power supply. (p. 78)
- The fuse is blown.  
→Repair the problem, and then replace the fuse. (p. 82)

## **Little or no sound comes from the speaker.**

- The squelch level is set too high.  
→Set the squelch (S-meter Squelch level) to the threshold point. (p. 13)
- The volume level is set too low.  
→Set the volume level to a suitable level. (p. 3)

## **You cannot transmit.**

- Some channels are set for receive only by regulations.  
→Change channels. (p. 9)

## **No beep sounds.**

- The Key Beep function is OFF.  
→Turn ON the function. (p. 72)

## **The Main screen is not displayed at power ON.**

- The MMSI (DSC self ID) code is not set.  
→Set the MMSI (DSC self ID) code. (p. 8)

## **Individual or Group ID cannot be set.**

- The entered ID code is incorrect. The first digit must be set to between '1' and '9' for an Individual ID.  
→Enter a correct ID code. (p. 22)

## **“??” blinks instead of the position and time.**

- Four hours have passed since the position data was manually entered.  
→Re-enter the position and time. (p. 24)
- The GPS signal is not correctly received.  
→Manually enter the position and time. (p. 24)

## **“No Position” and “No Time” are displayed instead of the position and time.**

- The GPS antenna is not correctly connected.  
→Make sure the GPS antenna is located where it has a clear view to receive a signal from satellites. (p. 76)  
→Check the cable connection to GPS-DATA or GPS-ANT.
- The position and time have not been manually entered.  
→Manually enter the position and time. (p. 24)

## **Sensitivity is too low, and only strong signals can be heard.**

- The antenna is defective, or the coaxial cable connector is shorted or cut.  
→Repair the problem, and then reconnect the antenna connector. (p. 75)

## **Communication cannot be established.**

- The antenna is defective, or the coaxial cable connector is shorted or cut.  
→Repair the problem, and then reconnect the antenna connector. (p. 75)

## **The received DSC call content is not printed out.**

- The printer is not correctly connected, or the paper supply is exhausted.  
→Check the printer connection or add paper. (p. 76)

## **“The transceiver cannot receive or transmit. Contact your dealer” is displayed.**

- The transceiver's Phase Lock Loop is unlocked.  
→Contact your dealer.

## **The transceiver is locked up and does not respond.**

- A software error has occurred.  
→The transceiver will automatically restart after approximately 10 seconds have passed.

## **An alert is not received.**

### **(An icon such as “🔔” is not displayed in the Information area and/or on the popup screen.)**

- The BAM function is turned OFF by default.  
→Turn ON the BAM function. (pp. 18, 72)

## ■ I/O Sentences

### ◇ Version number

IEC 61162-1 Ed.5 (2016-08)

### ◇ GPS Input sentences (IEC 61162-1)

GGA, GLL, GNS, and RMC

### ◇ GPS Input sentence description

#### • GGA—Global positioning system (GPS) fix data

\$-GGA,hhmmss.ss,llll.ll,a,yyyy.yy,a,x,xx,x.x,x.x,M,x.x,M,x.x,xxxx\*hh<CR><LF>

1        2 3 4        5 6 7 8 9 10 11 12 13 14

1	UTC of position (000000.00 to 235959.99)	8	Horizontal dilution of precision (no use)
2	Latitude (0000.0000 to 9000.0000)	9	Antenna altitude above/below mean sealevel (no use)
3	N/S	10	Unit M
4	Longitude (00000.0000 to 18000.0000)	11	Geoidal separation (no use)
5	E/W	12	Unit M
6	GPS quality indicator (1 to 5)	13	Age of differential GPS data (no use)
7	Number of satellites in use (no use)	14	Differential reference station ID (no use)

#### • GLL—Geographic position—Latitude/longitude

\$-GLL,llll.ll,a,yyyy.yy,a,hhmmss.ss,A,a\*hh<CR><LF>

1 2 3 4        5 6 7

1	Latitude (0000.0000 to 9000.0000)	5	UTC of position (000000.00 to 235959.99)
2	N/S	6	Status (A=data valid, V= data invalid)
3	Longitude (00000.0000 to 18000.0000)	7	Mode indicator (A=Autonomous, D=Differential, N=No fix, S= Simulator mode)
4	E/W		

#### • GNS—GNSS fix data

\$-GNS,hhmmss.ss,llll.ll,a,yyyy.yy,a,c--c,xx,x.x,x.x,x.x,x.x,x.x,a\*hh<CR><LF>

1        2 3 4        5 6 7 8 9 10 11 12 13

1	UTC of position (000000.00 to 235959.99)	8	HDOP (no use)
2	Latitude (0000.0000 to 9000.0000)	9	Antenna altitude, meters (no use)
3	N/S	10	Geoidal separation, meters (no use)
4	Longitude (00000.0000 to 18000.0000)	11	Age of differential data (no use)
5	E/W	12	Differential reference station ID (no use)
6	Mode indicator (N=No fix, A=Autonomous, D=Differential, P=Precise, R=Real Time Kinematic, F=Float RTK, S=Simulator mode)	13	Navigational status indicator (no use)
7	Total number of satellites in use (no use)		

#### • RMC—Recommended minimum specific GNSS data

\$-RMC,hhmmss.ss,A,llll.ll,a,yyyy.yy,a,x,x,x,xxxxxx,x,x,a,a\*hh<CR><LF>

1        2 3 4        5 6 7 8 9 10 11 12 13

1	UTC of position fix (000000.00 to 235959.99)	8	Course Over Ground, degrees True (0.0 to 360.0)
2	Status (A=data valid, V=navigation receiver warning)	9	Date (010100 to 311249)
3	Latitude (0000.0000 to 9000.0000)	10	Magnetic variation, degrees (no use)
4	N/S	11	E/W
5	Longitude (00000.0000 to 18000.0000)	12	Mode Indicator (A=Autonomous, D=Differential, F=Float RTK, N=No fix, P=Precise, R=Real Time Kinematic, S=Simulator mode)
6	E/W	13	Navigational status indicator (no use)
7	Speed over ground, knots (0.0 to 100.0)		

10  
11

■ I/O Sentences

◇ Remote Input and Output sentences (IEC 61162-1)

Input: FSI (Set or Query),

Output: FSI (Query receive), DSC (DSC receive), DSE (DSC receive)

◇ Remote sentence description

• FSI—Frequency set status or command

\$--FSI,xxxxxx,xxxxxx,c,x,a\*hh<CR><LF>  
           1      2      3 4 5

1	Transmitting frequency	5	Sentence status flag R=Sentence is a status report of current settings (use for a reply to a query). C=Sentence is a configuration command to change settings.
2	Receiving frequency		
3	Mode of operation		
4	Power level		

• Query sentence

\$--CTQ,FSI\*hh<CR><LF>

→ \$CTFSI,xxxxxx,xxxxxx,c,x,R\*hh<CR><LF>

• DSC – Digital selective calling information

\$CTDSC,xx,xxxxxxxxxx,xx,xx,xx,x.x,x.x,xxxxxxxxxx,xx,a\*hh<CR><LF>  
           1      2          3 4 5 6 7      8          9 10 11

1	Format Specifier (2 digits)	7	Time or Tel. No (Maximum 16 digits)
2	Address (10 digits)	8	MMSI of ship in distress (10 digits or NULL)
3	Category (2 digits or NULL)	9	Nature of Distress (2 digits or NULL)
4	Nature of Distress or First Telecommand (2 digits or NULL)	10	Acknowledgment (R=Acknowledge request, B=Acknowledgment, S=Neither (end of sequence ))
5	Type of Communication or Second Telecommand (2 digits)	11	Expansion indicator (E or NULL)
6	Position or Channel/Frequency (Maximum 16 digits)		

• DSE – Expanded Digital Selective Calling

\$CTDSE,x,x,a,xxxxxxxxxx,xx,c--c,.....,xx,c--c\*hh<CR><LF>  
           1 2 3      4          5 6      7      8 9

1	Total number of sentences (fixed value)	6	Data set '1' (code field, Enhanced position resolution, Maximum 8 characters), NULL
2	Sentence number (fixed value)	7	Additional data sets*1, NULL
3	Query/Reply flag (fixed value A=Automatic)	8	Data set 'n' (NULL)*1
4	Vessel MMSI (10 digits)	9	Data set 'n' (NULL)*1
5	Data set '1' (code field, fixed value 00)		

\*1 This transceiver outputs only "Data set 1."

## ■ BAM Sentences

### ◇ Version number

IEC 61162-1 Ed.5 (2016-08)

### ◇ Input sentences (IEC 61162-1)

ACN and HBT

### ◇ Input sentence description

#### • ACN—Alert command

\$--ACN, hhmmss.ss, aaa, x.x, x.x, c, a\*hh<CR><LF>  
                   1      2  3  4  5  6

1	Release time of the alert command (000000.00 to 235959.99, or NULL)	4	Alert Instance (1 to 999999, NULL*)
2	Manufacture mnemonic code (NULL)	5	Alert command (A=Acknowledge, Q=Request/Repeat information, O=Responsibility transfer, S=Silence)
3	Alert Identifier (Maximum 7 digits, 0=All alerts)	6	Sentence status flag (C)

\* Only when "Alert Identifier" is "0."

#### • HBT—Heartbeat supervision sentence

\$--HBT, x.x, A, x\*hh<CR><LF>  
                   1  2  3

1	Configured repeat interval
2	Equipment status (A=Yes, V=No)
3	Sequential sentence identifier (0 to 9)

### ◇ Output sentences (IEC 61162-1)

ALC, ALF, and ARC

### ◇ Output interval

ALC: 30 seconds

ALF: Irregular output (Output immediately when an alert occurs or the content of the sentence is changed.)

ARC: Irregular output (Output immediately when an ACN sentence cannot be accepted.)

### ◇ Output sentence description

#### • ALC—Cyclic alert list

\$--ALC, xx, xx, xx, x.x, aaa, x.x, x.x, x.x, ..... , aaa, x.x, x.x, x.x\*hh<CR><LF>  
                   1  2  3  4  5  6  7  8

1	Total number of sentences for this message (01 to 99)	5	Manufacturer mnemonic code (NULL)
2	Sentence number (01 to 99)	6	Alert identifier
3	Sequential message identifier (00 to 99)	7	Alert instance (1 to 999999)
4	Number of alert entries	8	Revision counter (1 to 99)

#### • ALF—Alert sentence

\$--ALF, x, x, x, hhmmss.ss, a, a, a, aaa, x.x, x.x, x.x, x, c---C\*hh<CR><LF>  
                   1  2  3      4      5  6  7  8  9  10 11 12 13

1	Total number of ALF sentences for this message (1 to 2)	8	Manufacturer mnemonic code (NULL)
2	Sentence number (1 to 2)	9	Alert identifier
3	Sequential message identifier (0 to 9)	10	Alert instance (1 to 999999)
4	Time of last change (000000.00 to 235959.99, or NULL)	11	Revision counter (1 to 99)
5	Alert category (A=Category A, B*=Category B, C=Category C)	12	Escalation counter (0 to 9)
6	Alert priority (E=Emergency Alarm, A=Alarm, W*=Warning, C*=Caution)	13	Alert text (Two sentences are output for an alert. One is "Alert title," the other is "Alert description.")
7	Alert state (A=Active – unacknowledged, S=Active – silenced, N=Active – acknowledged or active, O=Active – responsibility transferred, U=Rectified – unacknowledged, V=Normal)		

\* The transceiver can output.

# 11 DIGITAL INTERFACE (IEC 61162-1)

## ■ BAM Sentences

### • ARC—Alert command refused

\$--ARC, hhmmss.ss, aaa, x.x, x.x, c\*hh<CR><LF>

1            2    3    4    5

1	Release time of the Alert Command Refused (000000.00 to 235959.99, or NULL)	4	Alert Instance (1 to 999999)
2	Manufacture mnemonic code (NULL)	5	Refused alert command (A=Acknowledge, Q=Request/Repeat information, O=Responsibility transfer, S=Silence)
3	Alert Identifier		

## ■ Schematic diagram

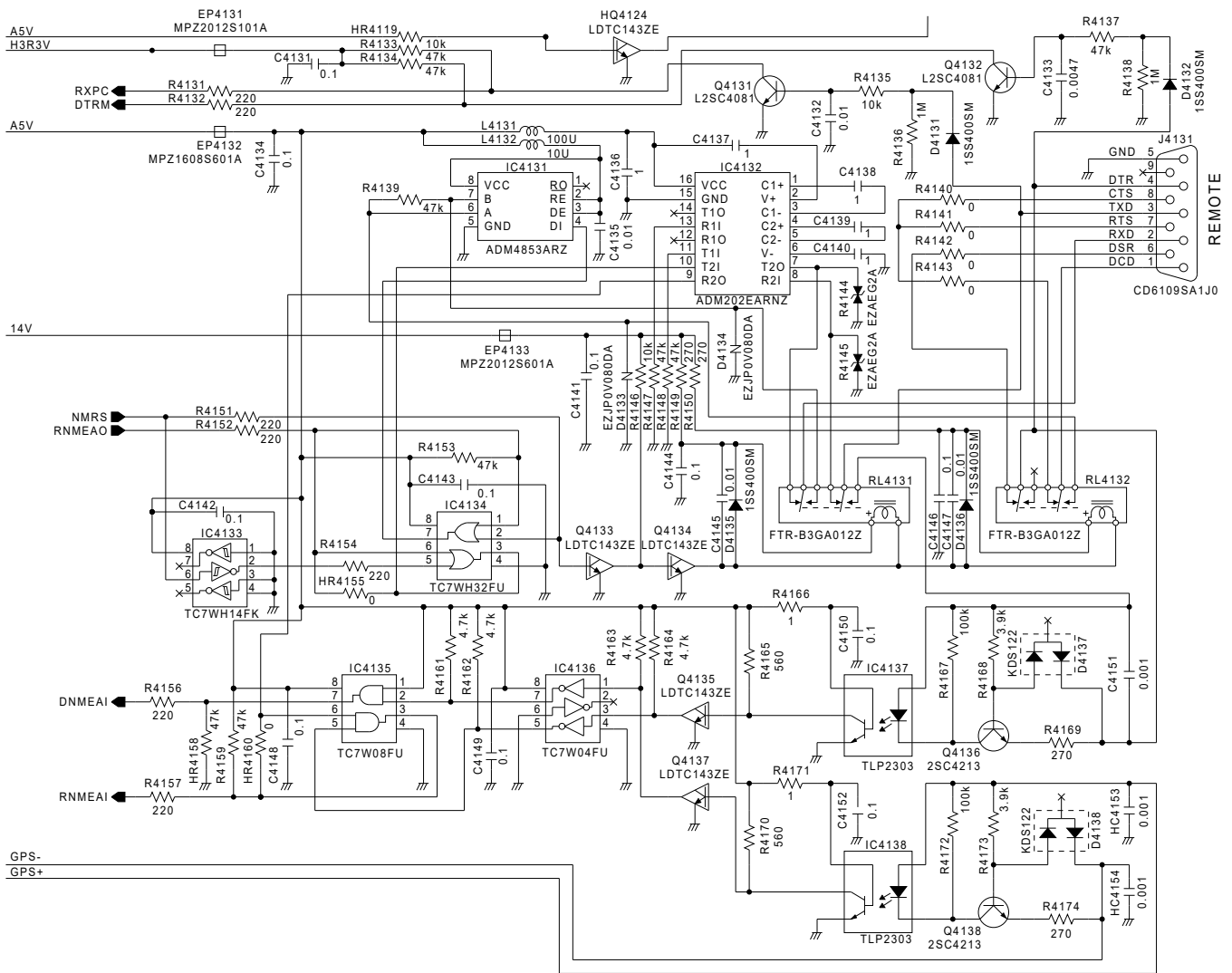



## Hardware version

The transceiver's hardware version is described on the serial number label, as shown below.



## Software version

You can confirm the transceiver's software version in the Menu screen.

1. Push [MENU].
2. Select "Radio Information."

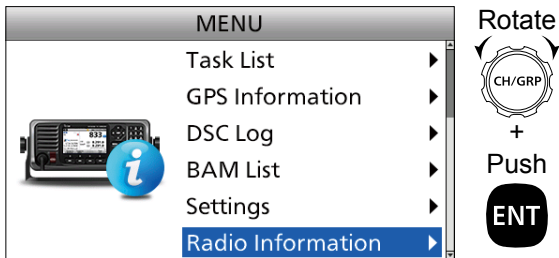

3. The transceiver's information is displayed.

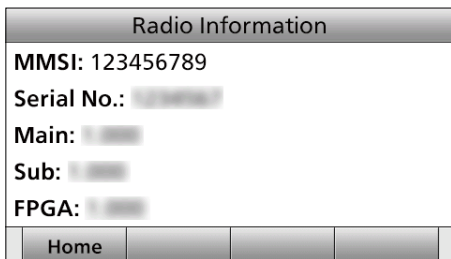

# 12 BAM ALERTS

You can receive the following BAM alerts.

• See page 18 for details of the BAM function.

ID	Priority	Category	Acknowledge	Responsibility transfer	Remove after rectified	Escalation properties	Alert title
3122	Warning	B	Yes	Yes	–	Repeated as a warning after 90 seconds.	DISTRESS: RX
3122	Warning	B	Yes	Yes	–	Repeated as a warning after 90 seconds.	DISTRESS: RELAY
3122	Warning	B	Yes	Yes	–	Repeated as a warning after 90 seconds.	URGENCY: RX
3123	Caution	B	–	–	–	–	SAFETY: COM ROUTINE: COM
3123	Caution	B	–	–	–	–	SAFETY: POS
3123	Caution	B	–	–	–	–	ROUTINE: POLL
3123	Caution	B	–	–	–	–	SAFETY: TEST
3123	Caution	B	–	–	–	–	SAFETY: POS
3016	Caution	B	–	–	–	–	SARPOSITION LOST

Alert description	What to do	Reasons and conditions
<ul style="list-style-type: none"> <li>• Type of message</li> <li>• MMSI code</li> <li>• Latitude</li> <li>• Longitude</li> </ul>	Check the received DSC call.	<ul style="list-style-type: none"> <li>• When the following DSC calls are received: <ul style="list-style-type: none"> <li>- Distress Call</li> <li>- Distress ACK</li> <li>- Distress Cancel</li> </ul> </li> <li>• The alert disappears when the message is read.</li> </ul>
<ul style="list-style-type: none"> <li>• Type of message</li> <li>• MMSI code</li> <li>• Latitude</li> <li>• Longitude</li> </ul>	Check the received DSC call.	<ul style="list-style-type: none"> <li>• When the following DSC calls are received: <ul style="list-style-type: none"> <li>- Distress Relay</li> <li>- Distress Relay ACK</li> </ul> </li> <li>• The alert disappears when the message is read.</li> </ul>
<ul style="list-style-type: none"> <li>• Type of message</li> <li>• MMSI code</li> </ul>	Check the received DSC call.	<ul style="list-style-type: none"> <li>• When the following DSC calls are received: <ul style="list-style-type: none"> <li>- Medical Transports</li> <li>- Ships and Aircraft</li> <li>- Geographic Area Call</li> <li>- Individual Call</li> <li>- Individual ACK</li> </ul> </li> <li>• The alert disappears when the message is read.</li> </ul>
<ul style="list-style-type: none"> <li>• Type of message</li> <li>• MMSI code</li> </ul>	Check the received DSC call.	<ul style="list-style-type: none"> <li>• When the following DSC calls are received: <ul style="list-style-type: none"> <li>- Geographic Area Call</li> <li>- Individual Call</li> <li>- Individual ACK</li> <li>- Group Call</li> </ul> </li> <li>• The alert disappears when the message is read.</li> </ul>
<ul style="list-style-type: none"> <li>• Type of message</li> <li>• MMSI code</li> </ul>	Check the received DSC call.	<ul style="list-style-type: none"> <li>• When the following DSC calls are received: <ul style="list-style-type: none"> <li>- Position Request</li> </ul> </li> <li>• The alert disappears when the message is read.</li> </ul>
<ul style="list-style-type: none"> <li>• Type of message</li> <li>• MMSI code</li> </ul>	Check the received DSC call.	<ul style="list-style-type: none"> <li>• When the following DSC calls are received: <ul style="list-style-type: none"> <li>- Polling Request</li> <li>- Polling Reply</li> </ul> </li> <li>• The alert disappears when the message is read.</li> </ul>
<ul style="list-style-type: none"> <li>• Type of message</li> <li>• MMSI code</li> </ul>	Check the received DSC call.	<ul style="list-style-type: none"> <li>• When the following DSC calls are received: <ul style="list-style-type: none"> <li>- Test Call</li> <li>- Test ACK</li> </ul> </li> <li>• The alert disappears when the message is read.</li> </ul>
<ul style="list-style-type: none"> <li>• Type of message</li> <li>• MMSI code</li> <li>• Latitude</li> <li>• Longitude</li> </ul>	Check the received DSC call.	<ul style="list-style-type: none"> <li>• When the following DSC calls are received: <ul style="list-style-type: none"> <li>- Position Reply</li> </ul> </li> <li>• The alert disappears when the message is read.</li> </ul>
<ul style="list-style-type: none"> <li>• Manual entry required</li> <li>• When 4 hours have passed: 4hrs have elapsed. Manual entry required</li> <li>• When 23.5 hours have passed: Position deleted. Manual entry required</li> </ul>	Manually update the position data.	<ul style="list-style-type: none"> <li>• When the position data has not been updated for 10 minutes (for 1 minute after turning ON the transceiver).</li> <li>• When the position data has not been updated for 4 hours.</li> <li>• After the position data has not been updated for 23.5 hours.</li> <li>• The alert disappears when the position data is updated or manually entered.</li> </ul>

► Continued on the next page.

## 12 BAM ALERTS

ID	Priority	Category	Acknowledge	Responsibility transfer	Remove after rectified	Escalation properties	Alert title
3013	Caution	B	–	–	–	–	DOUBTFUL POS
3115	Warning	B	Yes	Yes	No	Repeated as a warning after 90 seconds.	IMPAIRED RADIO
3079	Caution	B	–	–	–	–	OOW ATTENTION

Alert description	What to do	Reasons and conditions
<ul style="list-style-type: none"> <li>• Update the position</li> <li>• When 23.5 hours have passed: Position deleted. Update the position</li> </ul>	Update the position data.	<ul style="list-style-type: none"> <li>• When the position data has not been manually updated for 4 hours.</li> <li>• After the manually entered position data has not been updated for 23.5 hours.</li> <li>• The alert disappears when the position data is updated or manually entered.</li> </ul>
PLL is unlocked	You cannot transmit and receive. Contact your dealer.	<ul style="list-style-type: none"> <li>• When the transceiver's Phase Lock Loop (PLL) is unlocked.</li> <li>• The alert disappears when the PLL is locked.</li> </ul>
DSC task is full	Check the tasks. Delete unnecessary tasks.	<ul style="list-style-type: none"> <li>• When the transceiver holds 7 DSC tasks (including the RT mode task).</li> <li>• The alert disappears when there are 6 or less tasks.</li> </ul>

# INDEX

A	
Accessories .....	74
Antenna .....	78
AT-141 .....	75
Automatic Antenna Tuner function.....	14
Automatic Gain Control OFF .....	14
B	
Backlight	
Configuration .....	71
Function .....	11
BAM	
Alerts.....	19, 93
BAM List .....	20
Category .....	18
Function .....	72
Icon .....	20
Priority.....	18
Responsibility transfer .....	19
Software Key .....	21
Status.....	20
C	
Call log	
Received.....	62
Transmitted .....	62
Channel, Selecting .....	9
Clarity Control function .....	13
Connections	
Advanced.....	76
Basic.....	75
Connector information .....	83
D	
Digital interface.....	88
Dimensions.....	84
Display	
Channel and Frequency area .....	6
Information area.....	7
Position and Time area .....	7
Status area .....	6
Task area .....	6
Disposal.....	ii
Distress Acknowledgment	
Receiving.....	52
Sending.....	31
Distress call	
Receiving.....	51
Resending.....	28
Sending	
Regular call.....	27
Simple call.....	26
Distress Cancel call	
Receiving.....	53
Sending.....	29
Distress key.....	3
Distress Relay Acknowledgment	
Receiving.....	54
Sending.....	36
Distress Relay call	
Receiving.....	53
Sending.....	32
DROBOSE.....	32
DSC address ID	
Individual ID, Group ID	
Deleting.....	24
Entering.....	22
DSC scan .....	10
DSC Settings	
Alarm Status .....	66
Auto Print .....	67
Auto ACK .....	65
CH Auto Switch.....	66
DSC Data Output.....	66
DSC Frequency .....	63
Medical Transports .....	65
Position Input.....	24
Scanning Receiver.....	64
Self Check Test.....	67
Ships and Aircraft.....	65
DSC Task mode.....	25
E	
Emergency .....	i
Emergency FREQ channel.....	13
F	
Ferrite EMI filter .....	78
Fuses.....	82
G	
Geographic Area call	
Receiving.....	58
Sending.....	41
Ground connection .....	77
Group, Selecting.....	9
Group call	
Receiving.....	57
Sending.....	39
H	
Handset (HS-98).....	4
HM-214H .....	4
I	
Individual Acknowledgment	
Receiving.....	56
Sending.....	38
Individual call	
Receiving.....	55
Sending.....	37
Installation note .....	i
Instant Replay	
Function .....	11
Radio Settings .....	73
I/O Sentences.....	88
ITU Simplex channel .....	15
K	
Key Icon Description.....	iv

<b>M</b>		<b>S</b>	
MB-108.....	81	Scan .....	12
Medical Transports call		Schematic diagram.....	91
Receiving.....	61	Ships and Aircraft call	
Sending.....	48	Receiving.....	61
Menu		Sending.....	48
Configuration		S-meter squelch level.....	13
BAM.....	72	Software Key	
Display.....	71	Active.....	25
Inactivity Timer.....	72	AGC OFF.....	5
Key Assignment.....	16	Backlight.....	5
Key Beep.....	72	BAM List.....	5
MIC Key Lock.....	72	Clarity.....	5
Position Data Output.....	72	Compose Distress.....	5
UTC Offset.....	72	Compose DROBOSE.....	5
Radio		Compose Other.....	5
Auto Tune.....	73	DSC Log.....	5
Instant Replay.....	73	Emergency FREQ.....	5
MAX User Channel.....	73	Hold.....	25
Noise Reduction.....	73	Mode.....	5
Scan.....	73	NB.....	5
Voice SQL.....	73	NB Level.....	5
Radio Information.....	73	RF Gain.....	5
Menu screen		Scan.....	5
About the Menu screen.....	68	Speaker Output OFF.....	5
Construction.....	69	SQL.....	5
Selecting the item.....	68	S-SQL Level.....	5
MMSI code.....	8	Task List.....	5
Modem connector.....	2	TX FREQ Monitor.....	5
Mounting		Software maintenance.....	77
Location.....	79	Speaker Output function.....	14
Main unit.....	80	Specifications.....	85
Remote controller.....	79	Squelch function.....	13
		Supplied accessories.....	74
<b>N</b>		<b>T</b>	
Noise Blanker function.....	13	Temporary operating frequency.....	14
Noise blanker level.....	13	Test Acknowledgment	
Non-Distress calls		Receiving.....	60
Receiving.....	55	Sending.....	47
Sending.....	37	Test call	
		Receiving.....	60
<b>O</b>		Sending.....	46
Operating rules.....	1	Transmit Frequency Monitor function.....	13
Options.....	86	Transmitting.....	10
		Troubleshooting.....	87
<b>P</b>		<b>U</b>	
Panel description		User channel.....	15
Main unit.....	2		
Remote controller front panel.....	3	<b>V</b>	
Polling Request Acknowledgment, Sending.....	45	Version	
Polling Request call, Receiving.....	59	Hardware.....	92
Position data and time, Entering.....	24	Software.....	73, 92
Position Request Acknowledgment		<b>W</b>	
Receiving.....	59	Weatherproof cap.....	78
Sending.....	44		
Position Request Call			
Receiving.....	58		
Sending.....	43		
Power source.....	78		
Precautions.....	ii		
<b>R</b>			
Reassigning			
Software Key function.....	16		
Volume dial.....	17		
[P] key.....	17		
Receiving.....	10		
RF Gain level.....	13		

