

**THE TRANSCEIVERS**  
**IC-7850**  
**IC-7851**  
**Instruction Manual**

---

## PREFACE

---

Thank you for choosing the IC-7850/IC-7851. The IC-7850/IC-7851 has many built-in high technology circuitry and unique functions, such as the Dualwatch on the Main and Sub bands, a high speed spectrum scope scan, a high-resolution waterfall screen, and many other outstanding features.

The internal frequency signals in a radio utilizing a PLL are not always sufficiently pure. This results in a considerable number of unwanted spurious components, called phase noise, in its frequency spectrum. We focused intensively in drastically reducing the phase noise of LO (Local Oscillator) because the phase noise degrades the interference rejection and noise characteristics of the receiver. As a result, we succeeded in developing an LO with high purity outputs so that results in an RMDR (Reciprocal Mixing Dynamic Range) of 110 dB with newly developed 1.2 kHz Optimum Roofing Filter. Currently no competitors have been able to achieve this extremely high result performance. We believe we would not have been able to exceed the standard specifications without our full focus on LO purity.

In addition, Icom that has chosen to base the IC-7850/IC-7851 on an up-conversion, double super-heterodyne receiver design, which has many advantages over traditional receiver designs.

We are proud to have developed the IC-7850/IC-7851 for your amateur radio activities, and hope it brings you years of enjoyable operation.

Please read this instruction manual thoroughly before using the IC-7850/IC-7851.

### ABOUT CE AND DOC



Hereby, Icom Inc. declares that the versions of IC-7851 which have the “CE” symbol on the product, comply with the essential requirements of the Radio Equipment Directive, 2014/53/EU, and the restriction of the use of certain hazardous substances in electrical and electronic equipment Directive, 2011/65/EU. The full text of the EU declaration of conformity is available at the following internet address:

<http://www.icom.co.jp/world/support>

### DISPOSAL



The crossed-out wheeled-bin symbol on your product, literature, or packaging reminds you that in the European Union, all electrical and electronic products, batteries, and accumulators (rechargeable batteries) must be taken to designated collection locations at the end of their working life. Do not dispose of these products as unsorted municipal waste.

Dispose of them according to the laws in your area.

---

## IMPORTANT

---

**READ THIS INSTRUCTION MANUAL CAREFULLY** before attempting to operate the transceiver.

**SAVE THIS INSTRUCTION MANUAL.** This manual contains important safety and operating instructions for the transceiver.

---

## EXPLICIT DEFINITIONS

---

WORD	DEFINITION
⚠ <b>DANGER!</b>	Personal death, serious injury or an explosion may occur.
⚠ <b>WARNING!</b>	Personal injury, fire hazard or electric shock may occur.
<b>CAUTION</b>	Equipment damage may occur.
<b>NOTE</b>	Recommended for optimum use. No risk of personal injury, fire or electric shock.

---

## TRADEMARKS

---

Icom, Icom Inc. and Icom logo are registered trademarks of Icom Incorporated (Japan) in Japan, the United States, United Kingdom, Germany, France, Spain, Russia, Australia, New Zealand, and/or other countries.

This product includes “zlib” open source software, and is licensed according to the open source software license.

This product includes “libpng” open source software, and is licensed according to the open source software license.

Refer to the Text files in the License folder of included CD for information on the open source software being used by this product.

---

## PRECAUTIONS

---

⚠ **DANGER HIGH RF VOLTAGE! NEVER** attach an antenna or internal antenna connector during transmission. This may result in an electrical shock or burn.

⚠ **WARNING! NEVER** operate the transceiver with a headset or other audio accessories at high volume levels. The continuous high volume operation may cause a ringing in your ears. If you experience the ringing, reduce the volume level or discontinue use.

⚠ **WARNING! NEVER** operate or touch the transceiver with wet hands. This may result in an electric shock or damage to the transceiver.

⚠ **WARNING! NEVER** let metal, wire or other objects protrude into the transceiver or into connectors on the rear panel. This may result in an electric shock.

⚠ **WARNING!** Immediately turn the transceiver power OFF and remove the power cable if it emits an abnormal odor, sound or smoke. Contact your Icom dealer or distributor for advice.

**CAUTION: NEVER** put the transceiver in any unstable place (such as on a slanted surface or vibrated place). This may cause injury and/or damage to the transceiver.

**CAUTION: NEVER** put the transceiver's rear panel side down after lifting up the transceiver by holding rack mounting handle. This may scratch the surface of the place or damage the connectors on the transceiver's rear panel.

**CAUTION: NEVER** change the internal settings of the transceiver. This may reduce transceiver performance and/or damage to the transceiver.

In particular, incorrect settings for transmitter circuits, such as output power, idling current, etc., might damage the expensive final devices.

The transceiver warranty does not cover any problems caused by unauthorized internal adjustment.

**CAUTION: NEVER** block any cooling vents on the top, rear or bottom of the transceiver.

**CAUTION: NEVER** expose the transceiver to rain, snow or any liquids.

**CAUTION: NEVER** install the transceiver in a place without adequate ventilation. Heat dissipation may be reduced, and the transceiver may be damaged.

**CAUTION:** The transceiver weighs approximately 23.5 kg (52 lb). Always have two people available to carry, lift or turn over the transceiver.

**CAUTION:** The line-voltage receptacle must be near the transceiver and must be easily accessible.

**DO NOT** use extension cords.

**DO NOT** use harsh solvents such as benzene or alcohol when cleaning, as they can damage the transceiver's surfaces.

**DO NOT** push the PTT switch when you don't actually desire to transmit.

**DO NOT** use or store the transceiver in areas with temperatures below  $\pm 0^{\circ}\text{C}$  ( $+32^{\circ}\text{F}$ ) or above  $+50^{\circ}\text{C}$  ( $+122^{\circ}\text{F}$ ).

**DO NOT** place the transceiver in excessively dusty environments or in direct sunlight.

**DO NOT** place the transceiver against walls or putting anything on top of the transceiver. This may overheat the transceiver.

Always place unit in a secure place to avoid inadvertent use by children.

**BE CAREFUL!** If you use a linear amplifier, set the transceiver's RF output power to less than the linear amplifier's maximum input level, otherwise, the linear amplifier will be damaged.

**BE CAREFUL! NEVER** touch the transceiver top cover when transmitting continuously for long periods of time. The top cover may be hot.

Use Icom microphones only (supplied or optional). Other manufacturers' microphones have different pin assignments, and connection to the transceiver may damage the transceiver or microphone.

The LCD display may have cosmetic imperfections that appear as small dark or light spots. This is not a malfunction or defect, but a normal characteristic of LCD displays.

During maritime mobile operation, keep the transceiver and microphone as far away as possible from the magnetic navigation compass to prevent erroneous indications.

Turn [I/O] switch (on the rear panel) OFF and/or disconnect the AC power cable from the AC outlet when you will not use the transceiver for long period of time.



---

## FCC INFORMATION

---

This equipment has been tested and found to comply with the limits for a Class B digital device, pursuant to part 15 of the FCC Rules. These limits are designed to provide reasonable protection against harmful interference in a residential installation. This equipment generates, uses and can radiate radio frequency energy and, if not installed and used in accordance with the instructions, may cause harmful interference to radio communications. However, there is no guarantee that interference will not occur in a particular installation. If this equipment does cause harmful interference to radio or television reception, which can be determined by turning the equipment off and on, the user is encouraged to try to correct the interference by one or more of the following measures:

- Reorient or relocate the receiving antenna.
- Increase the separation between the equipment and receiver.
- Connect the equipment into an outlet on a circuit different from that to which the receiver is connected.
- Consult the dealer or an experienced radio/TV technician for help.

This device complies with Part 15 of the FCC Rules. Operation is subject to the following two conditions: (1) this device may not cause harmful interference, and (2) this device must accept any interference received, including interference that may cause undesired operation.

**WARNING:** MODIFICATION OF THIS DEVICE TO RECEIVE CELLULAR RADIOTELEPHONE SERVICE SIGNALS IS PROHIBITED UNDER FCC RULES AND FEDERAL LAW.

**CAUTION:** Changes or modifications to this device, not expressly approved by Icom Inc., could void your authority to operate this device under FCC regulations.

---

## ABOUT THE SUPPLIED CD

---

The following instructions and installers are included on the CD.

- **Instruction manual**  
Instructions for the full operations, the same as this manual
- **Schematic diagram**  
Includes the schematic and block diagrams
- **Adobe® Acrobat® Reader® Installer**  
Installer for Adobe® Acrobat® Reader®

To read the Instruction manual or Schematic diagram, Adobe® Acrobat® Reader® is required. If you have not installed it, please install the Adobe® Acrobat® Reader® on the CD or downloaded it from Adobe Systems Incorporated's website.

A PC with the following Operating System is required.

- Microsoft® Windows® 10, Microsoft® Windows® 8.1, Microsoft® Windows® 7

### ◇ Starting the CD

- ① Insert the CD into the CD drive.
  - Double click "Menu.exe" on the CD.
  - Depending on the PC setting, the Menu screen shown below is automatically displayed.
- ② Click the desired button to open the file.
  - To close the Menu screen, click [Quit].

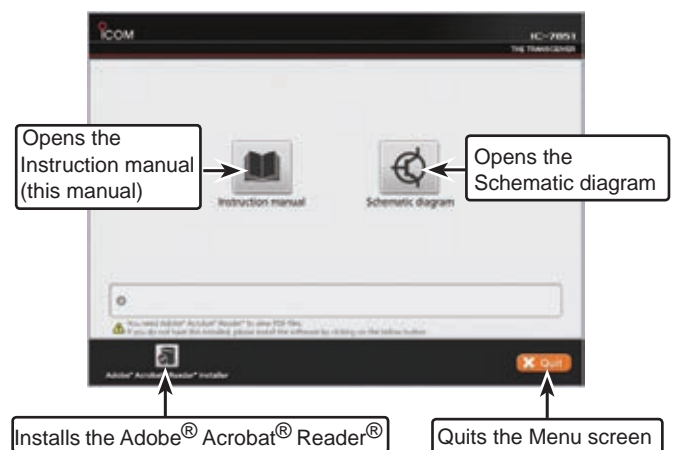

# FUNCTIONS AND FEATURES of Adobe® Acrobat® Reader

The following functions and features can be used with Adobe® Reader®.

## • Keyword search

Click "Find" (Ctrl+F) or "Advanced Search" (Shift+Ctrl+F) in the Edit menu to open the search screen. This is convenient when searching for a particular word or phrase in this manual.

\*The menu screen may differ, depending on the Adobe® Acrobat® Reader® version.

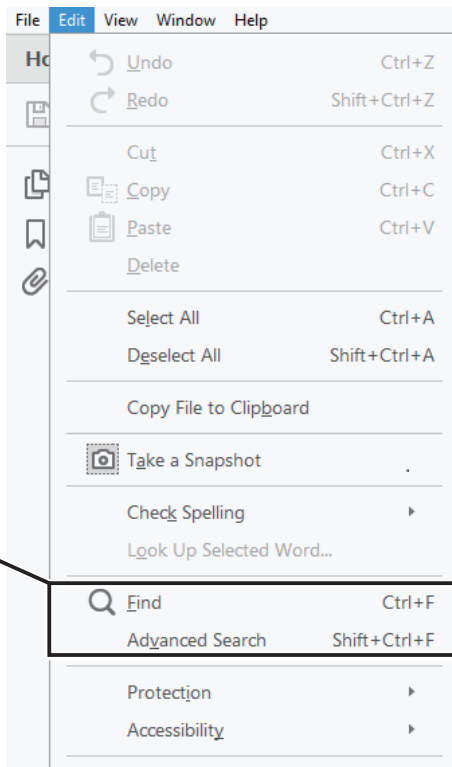

Click to open the find or search screen or advanced search screen.

## • Find screen

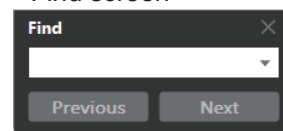

## • Advanced search screen

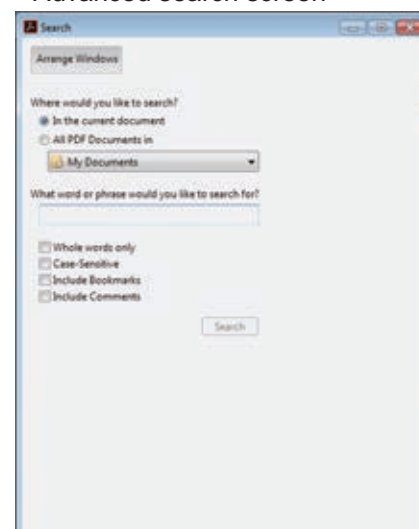

## • Printing out the desired pages.

Click "Print" in File menu, and then select the paper size and page numbers you want to print.

\*The printing setup may differ, depending on the printer. Refer to your printer's instruction manual for details.

\*Select "A4" size to print out the page in the equalized size.

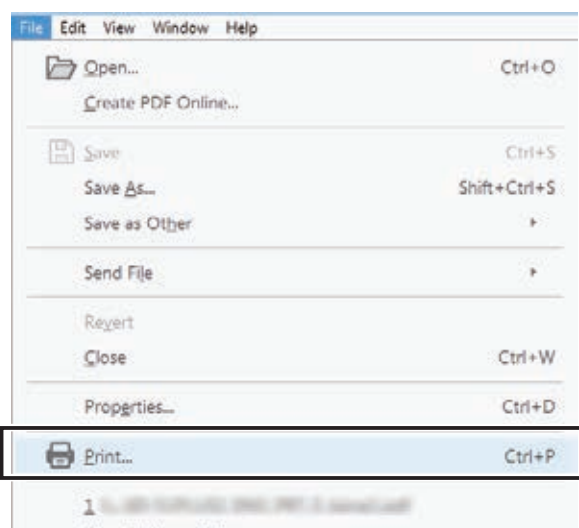

## • Read Out Loud feature.

The Read Out Loud feature reads aloud the text in this Instruction Manual.

Refer to the Adobe® Acrobat® Reader® Help for the details.

(This feature may not be usable, depending on your PC environment including the operating system.)

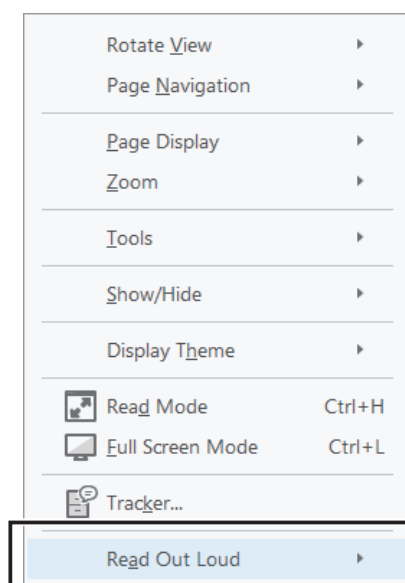

\*The screen may differ, depending on the Adobe® Acrobat® Reader® version.

## DESCRIPTION INFORMATION

This instruction manual is described based on the following manner.

“ ” (**Quotation marks**): Used to indicate icons, setting items, and screen titles displayed on the screen.

[ ] (**brackets**): Used to indicate keys, dials, and knobs.

### Routes to the Set mode and setting screen descriptions

Routes to the Set mode, setting screen and the setting items are described in the following manner.

#### SET [F-7] ∟ OTHERS [F-5] ∟ Beep (Band Edge)

The Multi-function screens are OFF.

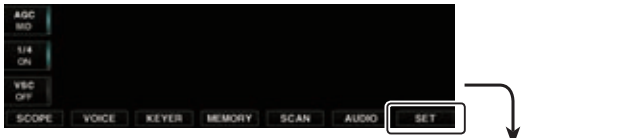

The Set mode menu screen.

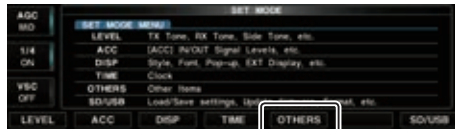

The Others set screen.

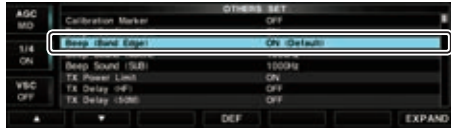

### ■ Band edge warning beep

This function allows you to hear a beep tone when you tune in or out of an amateur band's frequency range. A regular beep sounds when you tune into a range, and a lower tone error beep will sound when you tune out of a range.

○ The Multi-function screens are OFF:

- ① Select the "Beep (Band Edge)" item in the Others set screen.

#### SET [F-7] ∟ OTHERS [F-5] ∟ Beep (Band Edge)

- ② Rotate [MAIN DIAL] to select the option.

• Band Edge Beep options:

- OFF: Band edge beep is OFF.
- ON (Default): When you tune into or out of the default amateur band's frequency range, a beep sounds. (default)

### About the transceiver's illustrations

To indicate the keys and knobs in the operating steps, the transceiver is illustrated as illustrated below.

Also, the keys and knobs are described in the following manner.

#### ▶ Multi-function keys

Example: Push the Multi-function [METER] (▶) key.

#### (F) Function key

Example: Push [SCOPE] (F).

#### Mode key

Example: Push the Mode key [SSB].

#### ▶ Multi-function keys

#### Band key

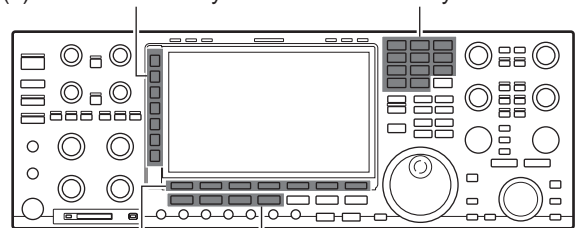

#### (F) Function keys

#### Mode keys

### About the LCD monitor display

Due to the printing matter, the Display type differs from the IC-7850 default settings.

# SUPPLIED ACCESSORIES

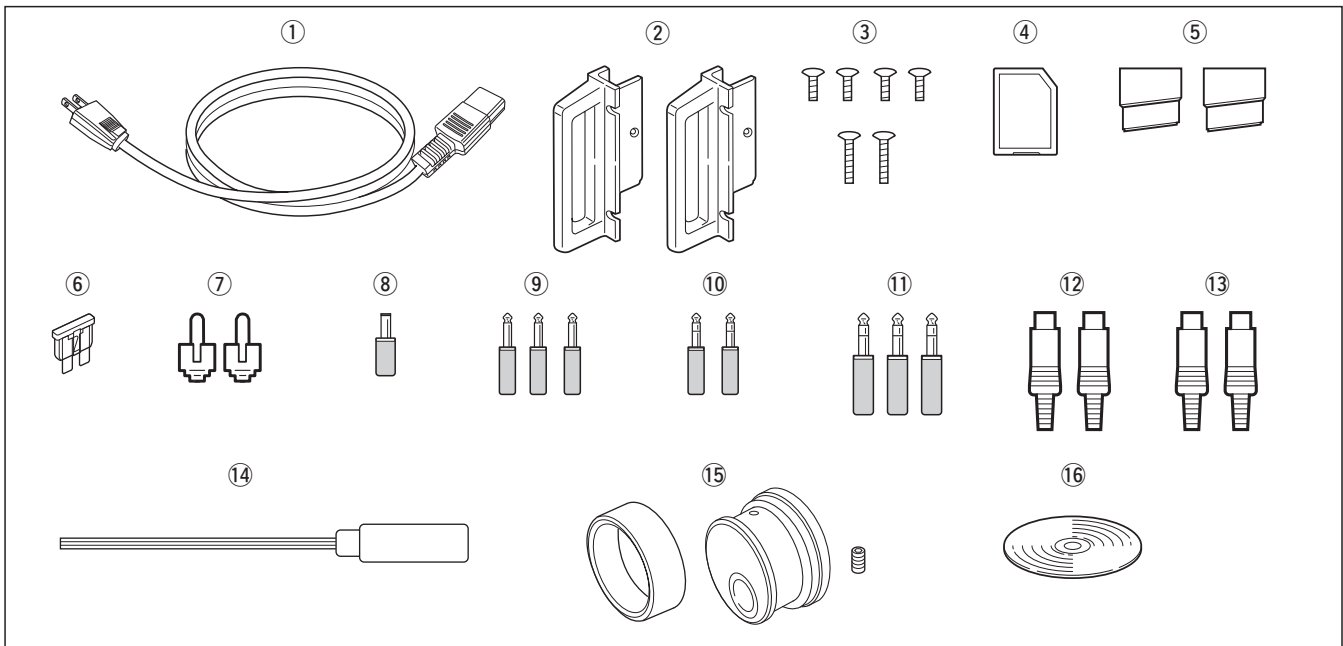

- ① AC power cable† ..... 1
- ② Rack mounting handles ..... 1 pair
- ③ Screws for rack mounting handles..... 1 set
- ④ SD card ..... 1
- ⑤ Feet ..... 1 pair
- ⑥ Spare fuse (2 A) ..... 1
- ⑦ RCA plugs ..... 2
- ⑧ DC plug ..... 1
- ⑨ 2-conductor 1/8" plugs ..... 3
- ⑩ 3-conductor 1/8" plugs ..... 2
- ⑪ 3-conductor 1/4" plugs ..... 3
- ⑫ ACC plugs (7-pin) ..... 2
- ⑬ ACC plugs (8-pin) ..... 2
- ⑭ Hexagonal wrench† ..... 1
- ⑮ Main dial† ..... 1
- ⑯ CD ..... 1

† May differ from that shown depending on the version.

‡ See page 3-3 for the Main dial attachment details.

---

# TABLE OF CONTENTS

---

## PANEL DESCRIPTION Section 1

---

■ Front panel .....	1-2
■ Rear panel .....	1-12
■ Display .....	1-14
■ Screen menu arrangement .....	1-16

## SET MODE ITEMS Section 2

---

■ About the Setting screen configuration .....	2-2
■ SCOPE SET .....	2-3
■ VOICE SET .....	2-4
■ KEYSER 001 .....	2-4
■ KEYSER CW-KEY .....	2-5
■ RTTY LOG SET .....	2-5
■ RTTY DECODE SET .....	2-5
■ PSK LOG SET .....	2-6
■ PSK DECODE SET .....	2-6
■ SCAN SET .....	2-6
■ AUDIO SCOPE SET .....	2-6
■ LEVEL SET .....	2-7
■ ACC SET .....	2-8
■ DISPLAY SET .....	2-10
■ TIME SET .....	2-11
■ OTHERS SET .....	2-11
■ LOAD SET .....	2-16
■ SAVE SET .....	2-16
■ ANT TYPE .....	2-16
■ VOX .....	2-17
■ NB .....	2-17
■ FILTER SHAPE SET .....	2-17

## INSTALLATION AND CONNECTIONS Section 3

---

■ Unpacking .....	3-2
■ Selecting a location .....	3-2
■ Grounding .....	3-2
■ Attaching the rack mounting handle .....	3-2
■ Connecting antenna .....	3-3
■ Required connections .....	3-4
◇ Front panel (Electronic keyer and microphone) .....	3-4
◇ Rear panel (Basic connection) .....	3-4
■ Advanced connections .....	3-5
◇ Front panel (Microphone, headphones and SD card) .....	3-5
◇ Rear panel (Optional products and external equipment) .....	3-5
◇ Rear panel (Optional products and external equipment) .....	3-6
◇ Rear panel (External keypad and meter) .....	3-6
■ Linear amplifier connections .....	3-7
◇ Connecting the IC-PW1/EURO .....	3-7
◇ Connecting a non-Icom linear amplifier .....	3-7
■ Transverter jack information .....	3-8
■ FSK and AFSK (SSTV) connections .....	3-8

---

# TABLE OF CONTENTS

---

■ Microphones (optional products) .....	3-9
◇ SM-50 .....	3-9
◇ SM-30 .....	3-9
◇ HM-36 .....	3-10
■ Connecting the RC-28 (Optional product) .....	3-10

## BASIC OPERATION   Section 4

---

■ When first applying power .....	4-2
■ Power ON .....	4-3
◇ Resetting the CPU (initial setup) .....	4-3
■ Adjusting the Volume level .....	4-4
■ Adjusting the Squelch level .....	4-4
■ Adjusting the RF gain .....	4-4
■ Selecting Main and Sub bands .....	4-5
■ Selecting the VFO or memory mode .....	4-5
■ Selecting an operating band.....	4-6
◇ Using the band stacking registers .....	4-6
■ Setting the frequency .....	4-7
◇ Tuning with [DIAL] .....	4-7
◇ About the Quick tuning step.....	4-7
◇ Selecting the Fine tuning function .....	4-8
◇ About the Auto tuning step function .....	4-8
◇ About the 1/4 tuning step function .....	4-9
◇ Entering the frequency with the keypad.....	4-9
■ Operating mode selection.....	4-10
■ Selecting the Meter readout.....	4-11
◇ Digital multi-function meter .....	4-11
◇ Selecting the meter type .....	4-12
■ Dial lock function .....	4-12
■ Basic transmit operation .....	4-13
◇ Transmitting .....	4-13
◇ Adjusting the microphone gain .....	4-13
◇ Drive gain adjustment .....	4-14
◇ Transmit power limit .....	4-14
■ Band edge warning beep .....	4-15
◇ Entering the user band edge .....	4-16
■ About the 5 MHz frequency band operation (USA version only) ...	4-18

## RECEIVE AND TRANSMIT   Section 5

---

■ Convenient functions for Receive .....	5-2
■ Convenient functions for Transmit .....	5-3
■ Operating SSB .....	5-4
■ Operating CW.....	5-5
◇ About the CW pitch control .....	5-6
◇ APF (Audio Peak Filter) operation .....	5-6
◇ Adjusting the Key speed .....	5-7
◇ About the CW reverse mode .....	5-7
◇ CW side tone function .....	5-7
◇ About 137 kHz band operation (Europe version only) .....	5-8

---

## TABLE OF CONTENTS

---

■ Electronic keyer functions .....	5-9
◇ Memory keyer screen .....	5-10
◇ Editing a Keyer memory .....	5-11
◇ Contest number set mode .....	5-12
◇ Keyer set mode .....	5-13
■ Operating RTTY (FSK) .....	5-14
◇ About the RTTY reverse mode .....	5-15
◇ Twin peak filter .....	5-15
◇ Functions for the RTTY decoder display .....	5-16
◇ Setting the decoder threshold level.....	5-17
◇ RTTY memory transmission .....	5-17
◇ Automatic transmission/reception setting .....	5-18
◇ Editing the RTTY memory .....	5-19
◇ Turning ON the RTTY log .....	5-20
◇ Confirm the RTTY log contents .....	5-21
◇ RTTY decode set mode .....	5-22
■ Operating PSK .....	5-24
◇ Vector indicator and Waterfall display.....	5-25
◇ Functions for the PSK decoder display .....	5-26
◇ About the BPSK and QPSK modes .....	5-27
◇ About the BPSK31 and BPSK63 modes .....	5-27
◇ Setting the decoder threshold level.....	5-28
◇ About the PSK reverse mode .....	5-28
◇ AFC/NET function .....	5-28
◇ PSK memory transmission .....	5-29
◇ Automatic transmission/reception setting .....	5-30
◇ Editing the PSK memory .....	5-31
◇ Turning ON the PSK log .....	5-32
◇ Confirm the PSK log contents .....	5-33
◇ PSK decode set mode .....	5-34
■ Operating AM or FM .....	5-36
■ Repeater operation .....	5-37
◇ Checking the repeater input signal .....	5-37
◇ Repeater tone frequency setting.....	5-38
■ Tone squelch operation.....	5-39
■ Data mode (AFSK) operation .....	5-40

## SCOPE OPERATION Section 6

---

■ Spectrum scope screen .....	6-2
◇ Operating the Spectrum scope .....	6-3
◇ Center mode .....	6-4
◇ Fixed mode .....	6-5
◇ Dual scope screen.....	6-6
◇ Mini scope screen .....	6-6
◇ Scope attenuator .....	6-7
◇ Adjusting the Reference level .....	6-8
◇ Sweep speed .....	6-9
◇ Scope set screen .....	6-10
◇ USB mouse operation .....	6-14
■ Audio scope screen .....	6-15
◇ Audio scope set mode .....	6-16

---

# TABLE OF CONTENTS

---

## Functions for Receive Section 7

---

■ Preamplifier .....	7-2
■ Attenuator .....	7-2
■ RIT function.....	7-3
◇ RIT monitor function .....	7-3
■ AGC function control .....	7-4
◇ Selecting the preset value .....	7-4
◇ Adjusting the AGC time constant .....	7-4
◇ Setting the AGC time constant preset value .....	7-4
■ Twin PBT operation .....	7-5
■ IF filter selection .....	7-6
◇ IF filter selection.....	7-6
◇ DSP filter shape.....	7-7
◇ Roofing filter selection .....	7-7
◇ 1.2 kHz Filter calibration .....	7-8
◇ Filter shape set mode .....	7-9
■ Dualwatch operation .....	7-10
■ Noise blanker .....	7-11
◇ NB Set mode .....	7-11
■ Noise reduction .....	7-12
■ Digital selector .....	7-12
■ Notch function.....	7-13
◇ Auto notch function .....	7-13
◇ Manual notch function .....	7-13
■ Auto tuning function .....	7-14
■ Main/Sub band Tracking function.....	7-14
◇ Turning ON the Tracking function .....	7-14

## FUNCTIONS FOR TRANSMIT Section 8

---

■ About the VOX function .....	8-2
◇ Turning ON the VOX function .....	8-2
◇ Adjusting the VOX function .....	8-2
◇ VOX set mode .....	8-3
■ About the Break-in function .....	8-4
◇ Semi break-in operation .....	8-4
◇ Full break-in operation .....	8-4
■ About the ΔTX function.....	8-5
◇ ΔTX monitor function .....	8-5
■ About the Monitor function .....	8-5
■ Setting the Speech compressor (SSB only) .....	8-6
■ Setting the Transmit filter width (SSB/SSB-D only) .....	8-6
■ Operating the Split frequency .....	8-7
■ About the Quick split function .....	8-8
◇ Split lock function .....	8-8

## VOICE RECORDER FUNCTIONS Section 9

---

■ Recording function.....	9-2
■ Recording a QSO .....	9-3
◇ Quick recording .....	9-3
◇ Basic recording .....	9-3



---

## TABLE OF CONTENTS

---

■ Playing back the recorded audio (QSO).....	9-4
■ Operating while playing back .....	9-5
■ Deleting a recorded audio file .....	9-6
■ Deleting a recorded audio folder .....	9-6
■ Instant replay function .....	9-7
■ Recording the communication audio .....	9-8
■ Playing back the recorded audio .....	9-8
■ Recording or playing back a TX message .....	9-9
◇ Recording .....	9-9
◇ Playing back .....	9-9
◇ Programming a TX message name .....	9-10
■ Transmitting a recorded message .....	9-11
◇ Single TX .....	9-11
◇ Repeat TX .....	9-11
◇ Setting the transmit level .....	9-12
■ Voice Set mode .....	9-13
■ Saving a voice memory onto an SD card or USB flash drive .....	9-14

### USING AN SD CARD OR USB MEMORY Section 10

---

■ About the SD card .....	10-2
◇ Inserting the SD card .....	10-2
◇ Removing the SD card .....	10-2
■ SD/USB-Memory menu screen .....	10-3
◇ Save set screen .....	10-4
◇ Load set screen .....	10-4
■ Saving the setting data onto an SD card or USB flash drive .....	10-5
■ Loading the saved data files onto an SD card or USB flash drive ...	10-6
■ Saving with a different file name .....	10-7
■ Deleting a data file .....	10-8
■ Formatting an SD card or USB flash drive.....	10-8
■ Unmounting an SD card or USB flash drive .....	10-9
■ Screen Capture function .....	10-10
◇ Capturing the screen.....	10-10
◇ Viewing the captured screen .....	10-10

### MEMORY OPERATION Section 11

---

■ Memory channels .....	11-2
■ Memory channel selection .....	11-2
◇ Using the M-CH [▲] or [▼] keys .....	11-2
◇ Using the keypad .....	11-2
■ Memory list screen.....	11-3
◇ Selecting a memory channel using the Memory list screen .....	11-3
◇ Confirming programmed memory channels .....	11-3
■ Entering Memory channel contents .....	11-4
◇ Entering in the VFO mode .....	11-4
◇ Entering in the Memory mode .....	11-4
■ Copying Memory contents .....	11-5
◇ Copying in the VFO mode .....	11-5
◇ Copying in the Memory mode .....	11-5
■ Memory names .....	11-6

---

# TABLE OF CONTENTS

---

- ◇ Editing (programming) memory names ..... 11-6
- Memory clearing..... 11-6
- Memo pads ..... 11-7
  - ◇ Entering frequencies and operating modes into Memo pads ..... 11-7
  - ◇ Calling up a frequency and operating mode from Memo pads ... 11-8
  - ◇ Using the Memo pad list screen ..... 11-8

## SCANS Section 12

---

- Scan types ..... 12-2
- Preparation ..... 12-3
- Scan set mode ..... 12-4
- Programmed scan ..... 12-5
- Fine programmed scan ..... 12-6
- Memory scan operation ..... 12-7
- Select memory scan operation ..... 12-7
- Setting select memory channels ..... 12-8
  - ◇ Setting in the Scan screen ..... 12-8
  - ◇ Setting in the Memory list screen ..... 12-8
  - ◇ Erasing the select scan setting ..... 12-8
- $\Delta F$  scan operation ..... 12-9
- Fine  $\Delta F$  scan ..... 12-9
- Tone scan ..... 12-10
- Voice squelch control function ..... 12-10

## ANTENNA TUNER OPERATION Section 13

---

- Antenna connection and selection ..... 13-2
- Receive Antenna-I/O selection ..... 13-2
- Antenna memory settings..... 13-3
  - ◇ Antenna type selection ..... 13-4
  - ◇ Antenna selection mode ..... 13-5
  - ◇ Temporary memory ..... 13-5
  - ◇ Receive antenna I/O setting..... 13-6
- About the Antenna tuner ..... 13-7
- Using the Antenna tuner operation ..... 13-7
  - ◇ If the tuner cannot tune the antenna ..... 13-8

## CLOCK AND TIMERS Section 14

---

- Time set mode ..... 14-2
  - ◇ Setting the Date ..... 14-2
  - ◇ Setting the Current time ..... 14-2
  - ◇ Setting the UTC Offset ..... 14-2
  - ◇ Selecting the CLOCK2 Function ..... 14-3
  - ◇ Setting the CLOCK2 UTC Offset..... 14-3
  - ◇ Entering the CLOCK2 Name ..... 14-3
  - ◇ Setting the NTP Function ..... 14-4
  - ◇ Setting the NTP Server address ..... 14-4
- Setting the Daily timer ..... 14-5
- Setting the Sleep timer ..... 14-6
- Timer operation ..... 14-6

---

# TABLE OF CONTENTS

---

## SET MODE Section 15

---

■ Set mode description.....	15-2
◇ Set mode operation .....	15-2
◇ Screen arrangement .....	15-3
■ Level set screen .....	15-4
■ ACC set screen .....	15-6
■ Display set screen .....	15-10
■ Time set screen .....	15-12
■ Others set screen .....	15-13

## MAINTENANCE Section 16

---

■ Adjusting the Main dial brake .....	16-2
■ Using the Voice synthesizer operation .....	16-2
■ SWR reading .....	16-3
■ Calibration the Frequency (approximate) .....	16-4
■ Setting My call sign .....	16-5
■ Cleaning .....	16-7
■ Resetting the CPU .....	16-7
■ About protection indications .....	16-8
■ Opening the transceiver's case .....	16-8
■ Fuse replacement .....	16-9
■ Clock backup battery replacement .....	16-9
■ Troubleshooting .....	16-10
◇ Transceiver power .....	16-10
◇ Transmit and receive.....	16-10
◇ Scanning .....	16-11
◇ Display.....	16-11

## UPDATING THE FIRMWARE Section 17

---

■ General .....	17-2
◇ Checking the firmware version .....	17-2
■ Preparation .....	17-3
◇ File downloading .....	17-3
■ Firmware update— using an SD card/USB flash drive .....	17-4

## CONTROL COMMAND Section 18

---

■ Remote control (CI-V) information .....	18-2
◇ CI-V connection .....	18-2
◇ Preparing .....	18-2
◇ Data format.....	18-2
◇ Data content description .....	18-11

---

# TABLE OF CONTENTS

---

## SPECIFICATIONS AND OPTIONS Section 19

---

■ Specifications .....	19-2
◇ General .....	19-2
◇ Transmitter .....	19-2
◇ Receiver .....	19-3
◇ Antenna tuner .....	19-3
■ Options .....	19-4

## CONNECTOR INFORMATION Section 20

---

■ ACC socket .....	20-2
■ Microphone connector .....	20-3
■ [ELEC-KEY] jack .....	20-3
■ [KEY] jack .....	20-3
■ [EXT KEYPAD] jack .....	20-4
■ [REF I/O] connector .....	20-4
■ [X-VERTER] connector .....	20-4
■ [RELAY] jack .....	20-4
■ [METER] jack .....	20-5
■ [REMOTE] jack .....	20-5
■ [DC OUT] jack .....	20-5
■ [EXT-SP] jack .....	20-5
■ [S/P DIF] jack .....	20-5
■ [RX-I/O] connector .....	20-5

## INDEX

---

# PANEL DESCRIPTION

# Section 1

---

■ Front panel .....	1-2
■ Rear panel .....	1-12
■ Display .....	1-14
■ Screen menu arrangement .....	1-16

# 1 PANEL DESCRIPTION

## ■ Front panel

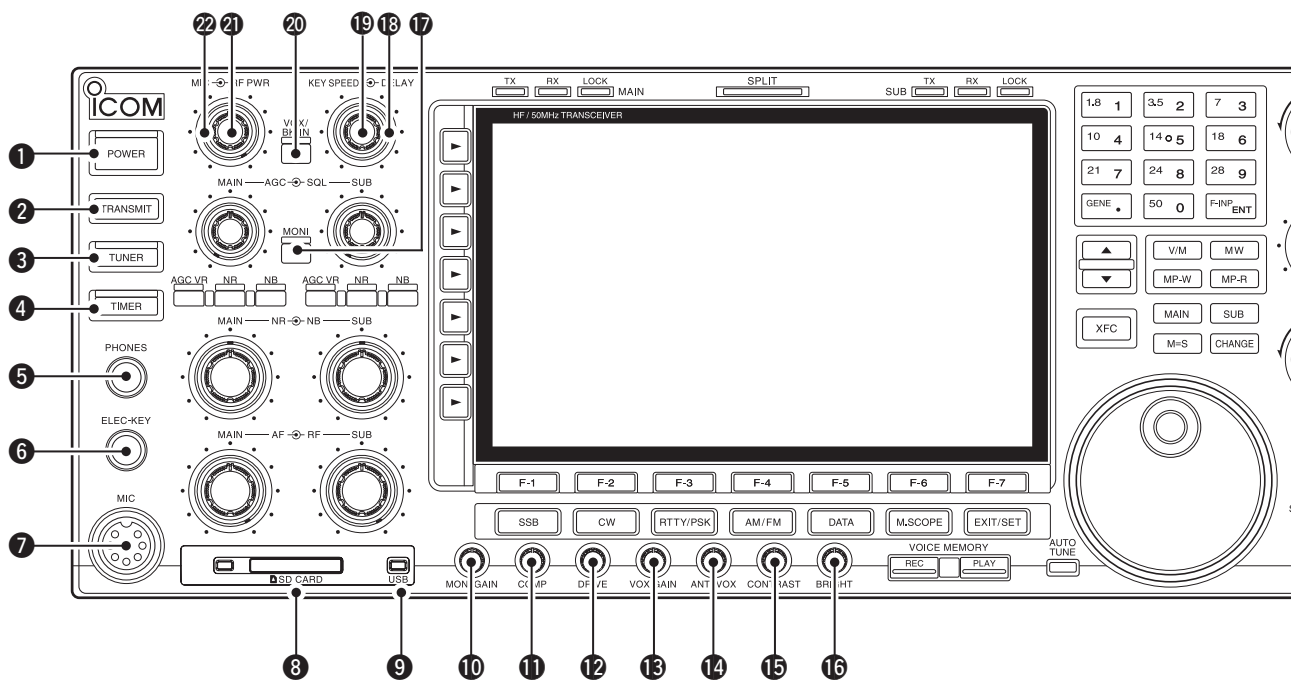

### 1 POWER KEY [POWER] (pp. 4-3, 14-6)

First, turn ON the internal power supply. The internal power supply switch is located on the rear panel. (p. 1-12)

- Push to turn ON the transceiver power.
  - The [POWER] indicator above this key lights blue.
- Hold down for 1 second to turn OFF the power.
  - The [POWER] indicator lights orange when the transceiver is OFF, but the internal power supply is turned ON.

### 2 TRANSMIT KEY [TRANSMIT] (p. 4-13)

Push to transmit, release to receive.

- The [TX] indicator lights red while transmitting and the [RX] indicator lights green when the squelch is open.

### 3 ANTENNA TUNER KEY [TUNER] (p.13-7)

- Momentarily push to turn the tuner ON or OFF (bypass.)
  - The [TUNER] indicator above this key lights white when the tuner is turned ON, and goes off when the tuner is turned OFF (bypassed).
- Hold down for 1 second to manually start the tuner.
  - The [TUNER] indicator blinks red during manual tuning.
  - When the tuner cannot tune the antenna, the tuning circuit is automatically bypassed after 20 seconds.

### 4 TIMER KEY [TIMER] (p. 14-5)

- Push to turn ON or OFF the sleep or daily timer function.
  - The [TIMER] indicator above this key lights white when the timer is in use.
- Hold down for 1 second to enter the Timer set screen.

### 5 HEADPHONE JACK [PHONES] (p. 3-5)

- Connect standard stereo headphones.
  - Output power: 50 mW with an 8 Ω load.
  - When headphones are connected, the internal speaker and any connected external speaker do not function.

### 6 ELECTRONIC KEYS JACK [ELEC-KEY] (p. 20-3)

- Connect a paddle to activate the internal electronic keyer for CW operation.
  - Select the internal electronic keyer, bug-key or straight key operation in the Keyer set screen. (p. 5-13)
  - A straight key jack is located on the rear panel. See [KEY] on page 1-13.
  - Set the keyer polarity (dot and dash) in the Keyer set screen. (p. 5-13)
  - Eight keyer memory channels can be used. (p. 5-11)

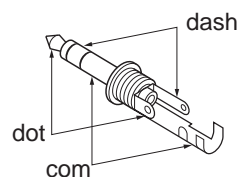

**7 MICROPHONE CONNECTOR [MIC]**

Connect an optional microphone.

- See page 3-4 for appropriate microphones.
- See page 20-3 for microphone connector information.

**8 SD CARD SLOT [SD CARD] (pp. 3-5, 10-2)**

Insert the supplied SD card for both reading and storing a wide variety of the transceiver's information and data.

- The indicator beside the slot lights, or blinks when reading from or writing to the card.
- Push the card once to remove it.

**9 USB INDICATOR [USB] (p. 10-4)**

Lights while accessing a USB flash drive inserted to the [USB A] port.

**10 MONITOR GAIN CONTROL [MONI GAIN] (p. 8-5)**

Rotate to adjust the transmit IF signal monitor level.

**11 COMPRESSION LEVEL CONTROL [COMP]**

(p. 8-6)

Rotate to adjust the speech compression level in SSB.

**12 DRIVE GAIN CONTROL [DRIVE] (p. 4-14)**

Rotate to adjust the transmitter level at the driver stage. Activates in all modes (except SSB with [COMP] OFF).

**13 VOX GAIN CONTROL [VOX GAIN] (p. 8-2)**

Rotate to adjust the transmit/receive switching threshold level for VOX operation.

**14 ANTI VOX CONTROL [ANTI VOX] (p. 8-2)**

Adjusts the VOX deactivate level to prevent unwanted VOX activation from the speaker or other sounds.

**15 DISPLAY CONTRAST CONTROL [CONTRAST]**

Adjusts the display contrast.

**16 DISPLAY BRIGHTNESS CONTROL [BRIGHT]**

Adjusts the display brightness.

**17 MONITOR KEY [MONI] (p. 8-5)**

Push to monitor your transmitted signal.

- The CW sidetone functions regardless of the [MONI] key setting in the CW mode.
- The [MONI] indicator above this key lights white while the function is activated.

**18 BREAK-IN DELAY CONTROL [DELAY] (p. 8-4)**

Rotate to adjust the transmit-to-receive switching delay time in the CW semi-break-in mode.

**19 ELECTRONIC CW KEYSER SPEED CONTROL [KEY SPEED] (p. 5-7)**

Rotate to adjust the internal electronic CW keyer's speed to between 6 wpm (minimum) and 48 wpm (maximum).

- The keyer's speed is displayed.

**20 VOX/BREAK-IN KEY [VOX/BK-IN]**

➔ Push to turn the VOX function ON or OFF in the SSB, AM, or FM mode. (p. 8-2)

➔ Push to turn the break-in function ON (Semi break-in, Full break-in) or OFF in the CW mode. (p. 8-4)

➔ Hold down for 1 second to enter the VOX set screen. (p. 8-3)

**✓ What is the VOX function?**

The VOX function (voice operated transmission) starts transmission without pushing the transmit key or PTT switch when you speak into the microphone, then automatically returns to receive when you stop speaking.

**✓ What is the break-in function?**

The break-in function toggles between transmit and receive with CW keying. Full break-in (QSK) can monitor the receive signal during keying.

**21 RF POWER CONTROL [RF PWR] (p. 4-13)**

Rotate to continuously vary the RF output power from less than 5 watts (minimum) to 200\* watts (maximum).

\*AM mode: less than 5 W to 50 W

- The output power setting is displayed.

**22 MIC GAIN CONTROL [MIC]**

Rotate to adjust microphone gain.

- The transmit audio tone in the SSB, AM, or FM mode can be independently adjusted in the Level set screen. (p. 4-13)

**✓ How to set the microphone gain.**

Adjust the [MIC] control so that the ALC meter swings within the ALC range during normal voice level transmission in the SSB or AM mode. (The ALC meter must be selected.)

# 1 PANEL DESCRIPTION

## ■ Front panel (Continued)

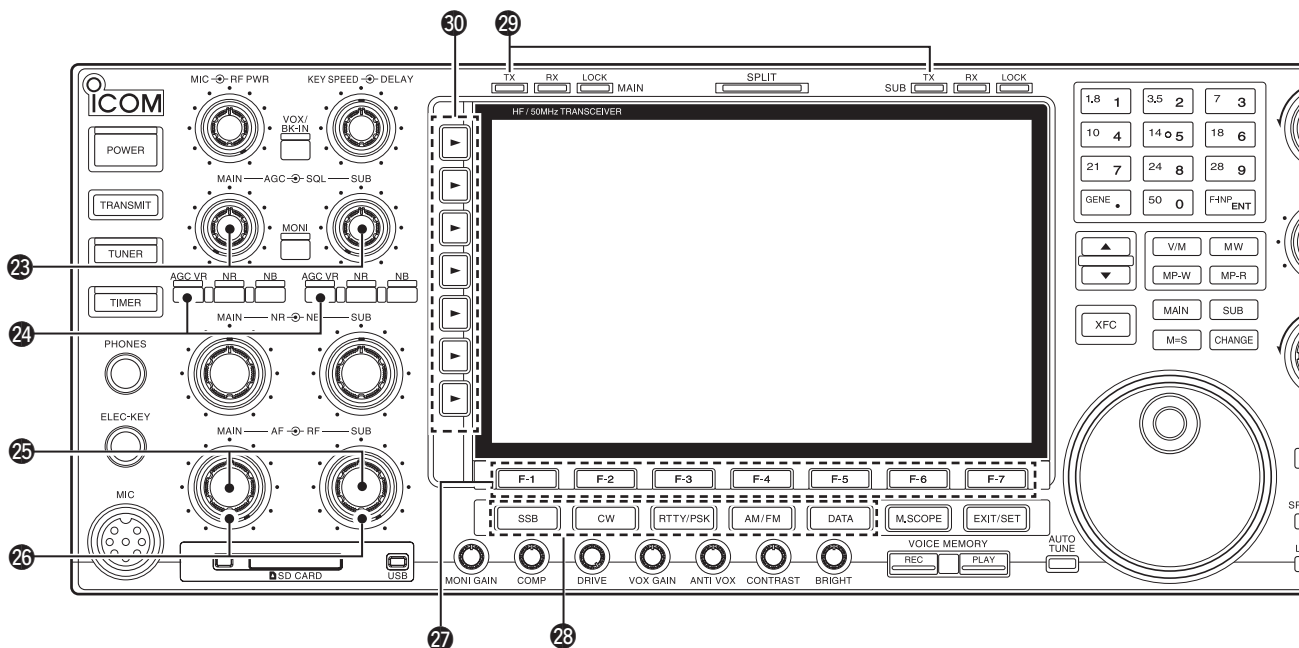

### 23 AGC CONTROL [AGC] (p. 7-4)

Rotate to adjust the continuously-variable AGC circuit time constant.

- To use the [AGC] control, push the appropriate band's [AGC VR] (The [AGC VR] indicator lights white).

### 24 AGC VOLUME KEY [AGC VR] (p. 7-4)

- Push to toggle the [AGC] control ON or OFF.
  - Use the [AGC] control to set the AGC time constant when switched ON.
  - The [AGC VR] indicator above this key lights white when the control is ON.
- Hold down for 1 second to turn OFF the AGC function.

### 25 AF CONTROL [AF] (p. 4-4)

Rotate to adjust the audio output level of the speaker or headphones.

### 26 RF GAIN CONTROL [RF] (p. 4-4)

Rotate to adjust the RF gain level.

While rotating the RF gain control, you may hear noise. This comes from the DSP unit and does not indicate a malfunction.

### 27 FUNCTION KEYS [F-1]–[F-7]

Push to select the function indicated in the display above these keys.

- Functions vary, depending on the operating mode.

### 28 MODE KEYS

Selects the desired mode. (p. 4-10)

- The Voice synthesizer announces the selected mode. (p. 16-2)

**SSB** ➤ Push to alternately select the USB or LSB mode.

**CW** ➤ Push to alternately select the CW or CW-R (CW reverse) mode.

**RTTY/PSK** ➤ Push to toggle between the RTTY and PSK modes.

- Hold down for 1 second to toggle between the RTTY and RTTY-R (RTTY reverse) modes.

- Hold down for 1 second to toggle between the PSK and PSK-R (PSK reverse) modes.

**AM/FM** ➤ Push to alternately select the AM or FM mode.

**DATA** ➤ Push to toggle between the SSB, AM, or FM data (USB-D, LSB-D, AM-D, FM-D) and voice modes.

- Hold down for 1 second to toggle between D1, D2, and D3.

### 29 TRANSMIT INDICATOR [TX]

Lights red while transmitting.

- The SUB band's [TX] indicator lights only when in split operation.



**30 MULTI-FUNCTION KEYS**

Push to select the functions indicated in the display to the right of these keys.

- Functions vary, depending on the operating mode.



- ➔ Push to select the ANT1, ANT2, ANT3 or ANT4 antenna connector. (p. 13-2)
- ➔ Hold down for 1 second to display the antenna selection memory. (p.13-5)
  - When the receive antenna is activated, the antenna that is connected to [ANT4] is used only for receive.

▨ When a transverter is used, this [ANT] does not function and "TRV" appears.



- ➔ Push to select the RF power (Po), SWR, ALC, COMP, Vd or Id metering while transmitting. (p. 4-11)
- ➔ Hold down for 1 second to turn the Digital multi-function meter ON or OFF. (p. 4-11)

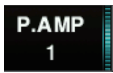

- ➔ Push to select one of two receive RF preamps, or bypass them. (p. 7-2)
  - "P.AMP1" activates a 10 dB preamp.
  - "P.AMP2" activates a 16 dB high-gain pre-amp.

**✓ What is a preamp?**

A preamp amplifies received signals in the front end circuit to improve S/N ratio and sensitivity. Select "P.AMP1" or "P.AMP2" when receiving weak signals.

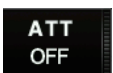

- ➔ Push to select the 6 dB, 12 dB or 18 dB attenuator. (p. 7-2)
- ➔ Hold down for 1 second to select the 3 dB, 6 dB, 9 dB, 12 dB, 18 dB, or 21 dB attenuator. (p. 7-2)

**✓ What is an attenuator?**

An attenuator prevents a desired signal from distorting when very strong signals are near the desired frequency, or when very strong electric fields, such as from a broadcasting station, are near your location.



- ➔ Push to activate and then select the "FAST," "MID," or "SLOW" AGC time constant. (p. 7-4)
  - In the FM mode, only "FAST" is selectable.
- ➔ Hold down for 1 second to enter the AGC set mode. (p. 7-4)

▨ The AGC time constant can be set between 0.1 to 8.0 second (depending on the mode), or turned OFF. When AGC is "OFF," the S-meter does not function.

**✓ What is AGC?**

The AGC controls receiver gain to produce a constant audio output level, even when the received signal strength varies dramatically. Select "FAST" for tuning and then select "MID" or "SLOW" depending on the receiving condition.



- ➔ Turns the speech compressor ON or OFF in the SSB mode. (p. 8-6)
- ➔ Selects the narrow, middle or wide compression when held down for 1 second.

**✓ What is a speech compressor?**

A speech compressor compresses the transmitter audio input to increase the average audio output level, and therefore increase the talk power. This function is effective for long-distance communication, or when propagation conditions are poor.

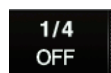

- ➔ Push to turn the 1/4-speed tuning function ON or OFF in the SSB data, CW, RTTY and PSK modes. (p. 4-9)
  - 1/4 function sets the dial rotation to 1/4 of the normal speed for fine tuning.

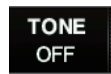

- ➔ In the FM mode, push to toggle between the tone encoder, tone squelch function and no-tone operation. (p. 5-39)
- ➔ In the FM mode, hold down for 1 second to enter the Tone set mode. (pp. 5-38, 5-39)



- ➔ Push to turn the Voice squelch control function ON or OFF. This is useful for scanning. (p. 12-10)

# 1 PANEL DESCRIPTION

## ■ Front panel (Continued)

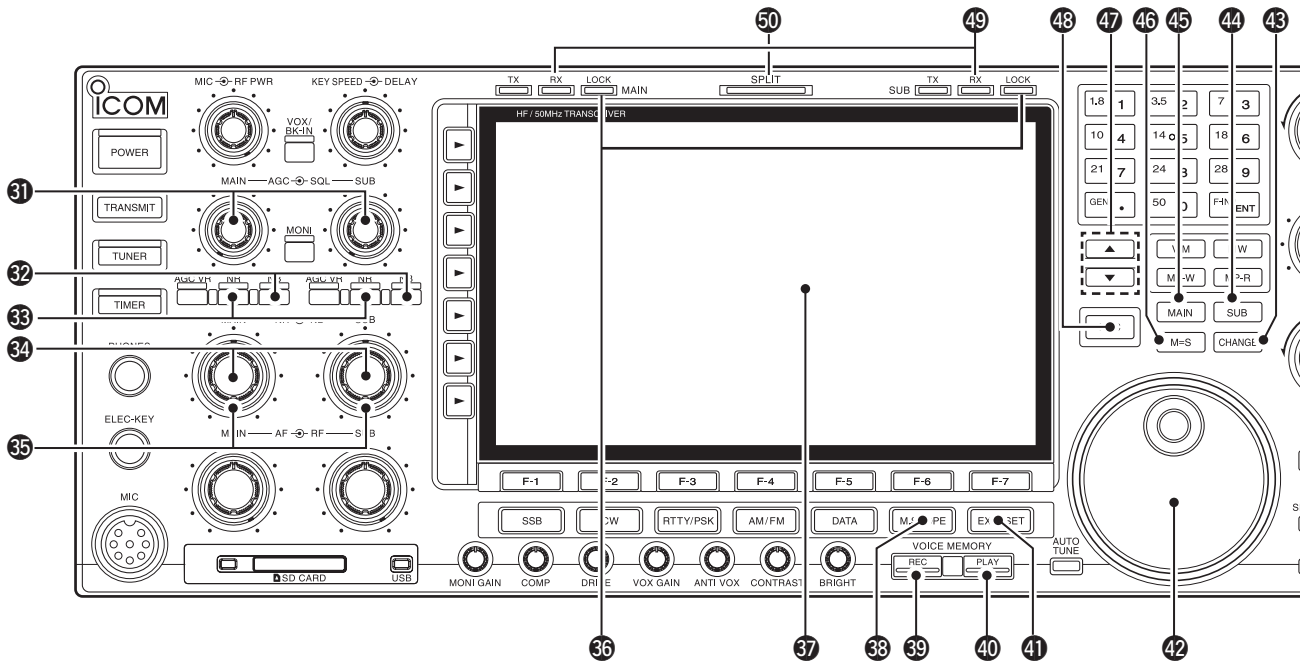

### 31 SQUELCH CONTROL [SQL] (p. 4-4)

Rotate to adjust the squelch threshold level. The squelch removes noise output from the speaker (closed condition) when no signal is received.

- The squelch is particularly effective for FM. It is also available for other modes.
- 11 to 12 o'clock position is recommended for any setting of the [SQL] control.

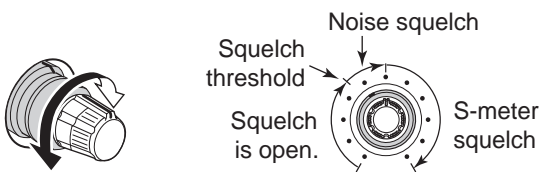

### 32 NOISE BLANKER KEY [NB] (p. 7-11)

- Push to turn the noise blanker ON or OFF. The noise blanker reduces pulse-type noise such as that generated by automobile ignition systems. This function cannot be used in the FM mode, or for non-pulse-type noise.
  - The [NB] indicator above this key lights white while the function is activated.
- Hold down for 1 second to enter the Noise blanker set mode.

### 33 NOISE REDUCTION KEY [NR] (p. 7-12)

Push to turn the DSP noise reduction ON or OFF.

- The [NR] indicator above this key lights white when the function is activated.

### 34 NOISE REDUCTION LEVEL CONTROL [NR] (p. 7-12)

Adjusts the DSP noise reduction level when the noise reduction is in use. Set for maximum readability.

- To use this control, push the appropriate Main or Sub band's [NR].

### 35 NOISE BLANKER CONTROL [NB] (p. 7-11)

Adjust the noise blanker threshold level.

- To use this control, push appropriate band's [NB] key.

### 36 LOCK INDICATOR [LOCK] (p. 4-12)

Lights when the dial lock function is activated.

### 37 FUNCTION DISPLAY (p. 1-14)

Shows the operating frequency, function key menus, Spectrum scope screen, Memory channel screen, Set mode settings, and so on.

- 38 MINI SPECTRUM SCOPE KEY [M.SCOPE]** (p. 6-2)
- ➔ Push to turn the Mini spectrum scope screen ON or OFF.
    - You can simultaneously display the Mini spectrum scope screen with other screens, such as the Memory or Set mode screens.
  - ➔ Hold down for 1 second to turn ON the regular spectrum scope screen.
- 39 VOICE MEMORY RECORD KEY [REC]**
- ➔ Push to store the previous received signal for the preset time period. This function is called Instant replay. (p. 9-7)
    - The preset time period can be set in the Voice set screen. (p. 9-13)
  - ➔ Hold down for 1 second to record a QSO (Communication) audio onto a memory device. (p. 9-3)
    - Hold down again for 1 second to stop recording.
    - The recorded memory device can be selected in the Voice set screen. (p. 9-13)
- 40 VOICE MEMORY PLAY BACK KEY [PLAY]** (pp. 9-2, 9-8)
- ➔ Push to playback the last 5 seconds of the Instant replay memory.
    - The playback time can be changed in the Voice set screen.
  - ➔ Hold down for 1 second to playback all of the instant replay memory.
    - The recording time can be changed in the Voice set screen.
- 41 EXIT/SET KEY [EXIT/SET]**
- ➔ Push to exit, or return to the previous screen indication during Spectrum scope, Memory, Scan or Set screen display.
  - ➔ Hold down for 1 second to display the Set mode menu screen. (p. 15-3)
- 42 MAIN DIAL**
- Changes the displayed frequency (Main band), selects set mode option, and so on.
- 43 MAIN/SUB CHANGE KEY [CHANGE]** (pp. 7-10, 8-7)
- Push to toggle the frequency and selected memory channel between the Main and Sub band readouts.
- When the split frequency function is ON, push to toggle between the transmit frequency and the receive frequency.
- 44 SUB BAND ACCESS KEY [SUB]**
- Push to select the Sub band readout.
- The Sub band readout frequency is clearly displayed.
- 45 MAIN BAND ACCESS KEY [MAIN]**
- Push to select the Main band readout.
- The Main band readout frequency is clearly displayed. The Sub band readout functions only during split operation or Dualwatch.
- 46 MAIN/SUB EQUALIZING KEY [M=S]** (p. 8-7)
- Hold down for 1 second to equalize the Sub band readout frequency to the Main band readout frequency.
- 47 MEMORY CHANNEL UP/DOWN KEYS [▲]/[▼]** (p. 11-2)
- Push to select the desired memory channel.
- Memory channels can be selected both in the VFO and the memory modes.
- 48 TRANSMIT FREQUENCY CHECK KEY [XFC]** (p. 6-5)
- Hold down to monitor the transmit frequency (including  $\Delta$ TX frequency offset) during split frequency operation.
- While holding down, the transmit frequency can be changed with [MAIN DIAL], keypad, memo pad or [▲]/[▼] keys.
  - When the split lock function is turned ON, push [XFC] to cancel the Dial lock function. (pp. 8-7, 8-8)
- 49 RECEIVE INDICATOR [RX]**
- Lights green while receiving a signal and when the squelch is open.
- 50 SPLIT OPERATION INDICATOR [SPLIT]** (p. 8-7)
- Lights white during split frequency operation.

# 1 PANEL DESCRIPTION

## ■ Front panel (Continued)

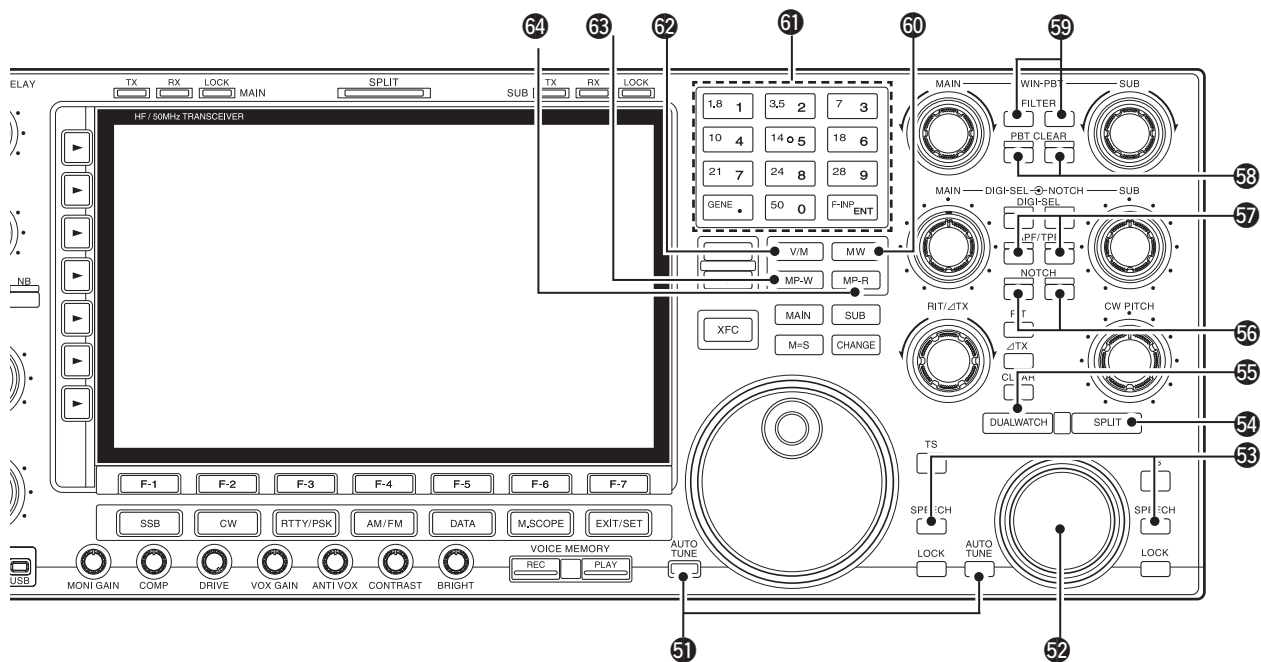

### 51 AUTOMATIC TUNING KEY [AUTO TUNE]

Push to turn ON the Automatic tuning function in the CW or AM mode.

#### **IMPORTANT!**

When receiving a weak signal, or receiving a signal with interference, the automatic tuning function may tune the receiver to an undesired signal.

### 52 SUB DIAL

Changes the displayed frequency in the Sub band.

### 53 SPEECH KEY [SPEECH] (p. 16-2)

- Push to announce the S-meter level and the selected operating frequency.
  - You can change the speech language, speech speed, and speech contents in the Others set screen. (p. 15-14)
- Hold down for 1 second to announce the selected operating mode.

### 54 SPLIT KEY [SPLIT] (pp. 8-7, 8-8)

- Push to turn the split function ON or OFF.
- Hold down for 1 second to turn the split function ON and equalize the Sub band frequency to the Main band in non-FM modes, and then sets the Sub band readout for frequency input mode. (Quick split function)
  - In the FM mode, the Sub band frequency is shifted by the preset frequency offset from the Main band readout frequency. (p. 15-14)
  - The quick split function can be turned OFF in the Others set screen. (p. 15-13)
- After entering a frequency offset, push to turn ON the split function. The Sub band frequency is shifted the offset amount from the Main band frequency.

### 55 DUALWATCH KEY [DUALWATCH] (p. 7-10)

- Push to turn the Dualwatch function ON or OFF.
- Hold down for 1 second to turn the Dualwatch function ON, and equalize the Main/Sub band frequency to the Sub/Main band. (Quick dualwatch function)
  - The Quick Dualwatch function can be turned OFF in the Others set screen. (p. 15-13)

**56 NOTCH KEY [NOTCH]** (p. 7-13)

- ➔ Push to select the Notch function between auto, manual, or OFF in the SSB or AM mode.
- ➔ Push to turn the Manual notch function ON or OFF in the CW, RTTY, or PSK mode.
- ➔ Push to turn the Auto notch function ON or OFF in the FM mode.
  - “**MN**” is displayed when the Manual notch filter is in use.
  - “**AN**” is displayed when the Auto notch filter is in use.
- ➔ Hold down for 1 second to select the Manual notch width from wide, mid, or narrow.

✓ **What is the Notch function?**

The notch function eliminates unwanted CW or AM carrier tones while preserving the desired voice signal. The DSP circuit automatically adjusts the filtering frequency to effectively eliminate unwanted tones.

**57 AUDIO PEAK FILTER/TWIN PEAK FILTER KEY [APF/TPF]**

**During CW mode operation** (p. 5-6)

- ➔ Push to turn the Audio peak filter ON or OFF.
  - “**APF**” appears when audio peak filter is in use.
- ➔ Hold down for 1 second to select the APF pass-band width from WIDE, MID, or NAR or from 320, 160, or 80 Hz, depending on the APF type setting.

**During RTTY mode operation** (p. 5-15)

- ➔ Push to turn the Twin peak filter ON or OFF.
  - “**TPF**” appears when twin peak filter is in use.

**58 PBT CLEAR KEY [PBT CLEAR]** (p. 7-5)

- ➔ Hold down for 1 second to clear the PBT settings.
  - The [PBT CLEAR] indicator above this key lights when the PBT function is in use.

**59 FILTER KEY [FILTER]** (p. 7-6)

- ➔ Push to select one of three IF filter settings.
- ➔ Hold down for 1 second to enter the Filter screen.

**60 MEMORY WRITE KEY [MW]** (p. 11-4)

- ➔ Hold down for 1 second to store the selected frequency and operating mode into the displayed memory channel.
  - This function is usable in both the VFO and memory modes.

**61 KEYPAD**

- ➔ Push to select the operating band.
  - Push [GENE] to select the general coverage band.
- ➔ Push the same key 2 or 3 times to call up other stacked frequencies in the band. (p. 4-6)
  - Icom’s triple band stacking register memorizes 3 frequencies in each band.
- ➔ After pushing [F-INP], push to enter a frequency or memory channel. Pushing [ENT] or [▲]/[▼] to save and exit. (pp. 4-9, 11-2)
  - Example: To enter 14.195 MHz, push [F-INP] [1] [4] [.] [1] [9] [5] [ENT].

**62 VFO/MEMORY KEY [V/M]**

- ➔ Push to toggle the selected operating mode between the VFO and memory. (pp. 4-5, 11-2)
- ➔ Hold down for 1 second to copy the memory contents to the VFO. (p. 11-5)

**63 MEMO PAD-WRITE KEY [MP-W]** (p. 11-7)

- ➔ Enters the selected frequency and operating mode into a memo pad.
  - The five most recent entries remain in the memo pads.
  - The number of memo pads can be expanded from 5 to 10 in the Others set screen. (p. 15-15)

**64 MEMO PAD-READ KEY [MP-R]** (p. 11-8)

- ➔ Push to call up a frequency and operating mode in a memo pad.
  - The 5 (or 10) most recently entered frequencies and operating modes can be recalled, starting from the most recent.
  - The number of memo pads can be expanded from 5 to 10 in Others set screen. (p. 15-15)
- ➔ Hold down for 1 second to enter the Memo pad list screen.



# 1 PANEL DESCRIPTION

## ■ Front panel (Continued)

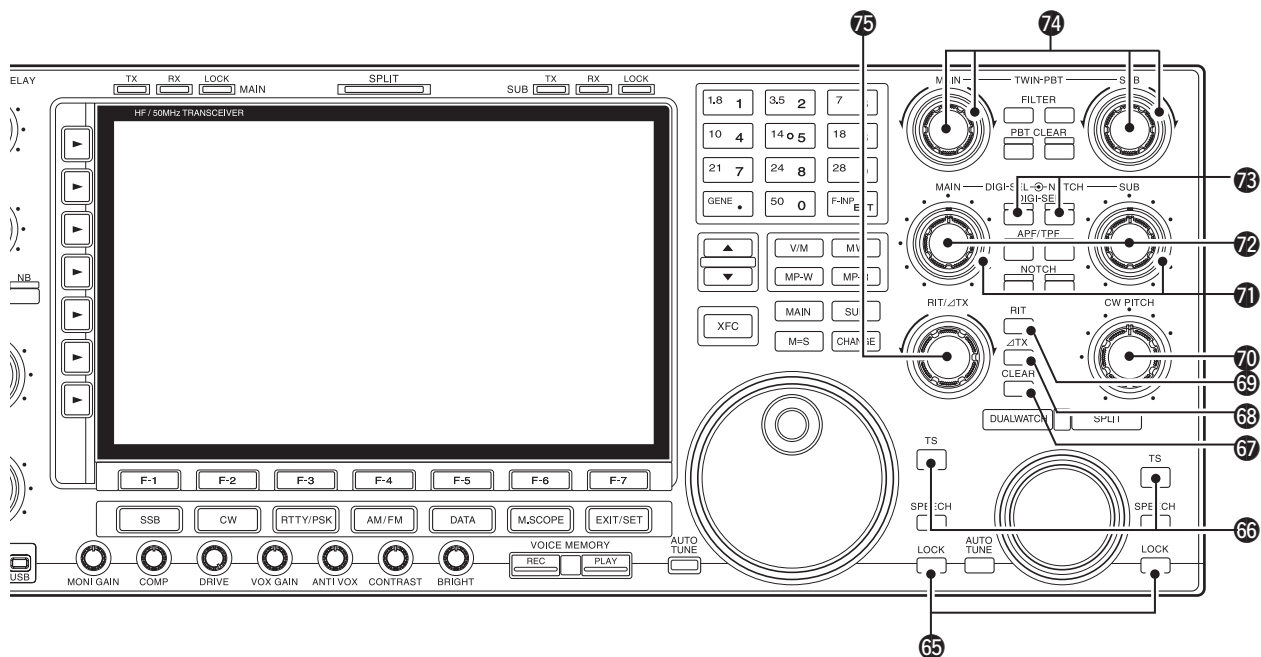

### 65 LOCK KEY [LOCK] (p. 4-12)

Push to turn the Dial lock function ON or OFF.

### 66 QUICK TUNING KEY [TS]

- Push to turn the Quick Tuning step function ON or OFF. (p. 4-7)
  - While the Quick Tuning icon, “▼,” is displayed above the frequency readout, the frequency can be changed in selected kHz steps.
  - 0.1, 1, 5, 9, 10, 12.5, 20 and 25 kHz steps can be independently set for each operating mode.
- When the Quick tuning step is OFF, hold down for 1 second to turn the 1 Hz tuning step ON or OFF. (p. 4-8)
- When the Quick Tuning step is ON, hold down for 1 second to enter the Quick Tuning step set screen. (p. 4-7)

### 67 CLEAR KEY [CLEAR] (pp. 7-3, 8-5)

You can clear the RIT/ $\Delta$ TX shift frequency by holding down for 1 second or pushing, depending on the quick RIT/ $\Delta$ TX clear function setting (p. 7-12-18).

### 68 $\Delta$ TX KEY [ $\Delta$ TX] (p. 8-5)

- Push to turn the  $\Delta$ TX function ON or OFF.
  - Rotate the [RIT/ $\Delta$ TX] control to vary the  $\Delta$ TX frequency.
- Hold down for 1 second to add the  $\Delta$ TX shift frequency to the operating frequency.

#### ✓ What is the $\Delta$ TX function?

$\Delta$ TX shifts the transmit frequency without shifting the receive frequency. This is useful for simple split frequency operation in CW, and so on.

### 69 RIT KEY [RIT] (p. 7-3)

- Push to turn the RIT function ON or OFF.
  - Rotate the [RIT/ $\Delta$ TX] control to vary the RIT frequency.
- Hold down for 1 second to add the RIT shift frequency to the operating frequency.

#### ✓ What is the RIT function?

Receiver incremental tuning (RIT) shifts the receive frequency without shifting the transmit frequency. This is useful for fine tuning stations calling you on off-frequency or when you prefer to listen to slightly different-sounding voice characteristics, and so on.

### 70 CW PITCH CONTROL [CW PITCH] (p. 5-6)

Shifts the received CW audio pitch and the CW side tone pitch without changing the operating frequency.

### 71 MANUAL NOTCH FILTER CONTROL [NOTCH] (p. 7-13)

Varies the “valley” frequency of the manual notch filter to reject an interfering signal while the manual notch function is ON.

- Notch filter center frequency:
  - SSB : -1060 Hz ~ 4040 Hz
  - CW : CW pitch frequency + 2540 Hz ~ CW pitch frequency - 2540 Hz
  - AM : -5100 Hz ~ 5100 Hz

### 72 DIGITAL RF SELECTOR CONTROL [DIGI-SEL] (p. 7-12)

- Adjusts the digital RF selector center frequency.
  - The control can be reassigned as the Audio peak filter adjustment (p. 15-15)

**73 DIGITAL RF SELECTOR KEY [DIGI-SEL]**

(p. 7-12)

Push to turn the digital RF preselector ON or OFF.

- The [DIGI-SEL] indicator lights white when the preselector is in use.

**74 PASSBAND TUNING CONTROLS [TWIN PBT]**

(p. 7-5)

Adjusts the receiver's IF filter 'passband width' using the DSP.

- The passband width and shift frequency are displayed in the Multi-function display.
- Hold down [PBT CLEAR] for 1 second to clear the PBT settings.
- The adjustment range is half of the selected filter passband width, and the value is adjustable in 25 Hz steps for the SSB/CW/RTTY/PSK modes, and 100 Hz steps for the AM mode.

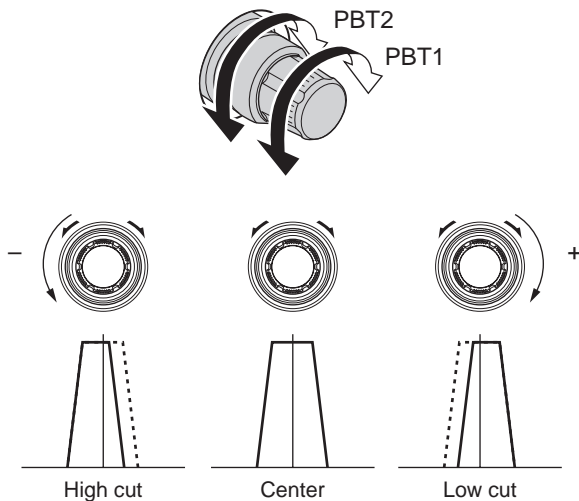
**✓ What is the PBT control?**

The PBT function electronically modifies the IF passband width to reject interference. This transceiver uses the DSP circuit for the PBT function.

**75 RIT/ $\Delta$ TX CONTROL [RIT/ $\Delta$ TX] (pp. 7-3, 8-5)**

Shifts the receive and/or transmit frequency without changing the transmit and/or receive frequency.

- Rotate the control clockwise to increase the frequency, or rotate the control counterclockwise to decrease the frequency. The RIT or  $\Delta$ TX functions must be ON.
- The shift frequency range is  $\pm 9.999$  kHz in 1 Hz steps (or  $\pm 9.99$  kHz in 10 Hz steps).

## ■ Rear panel

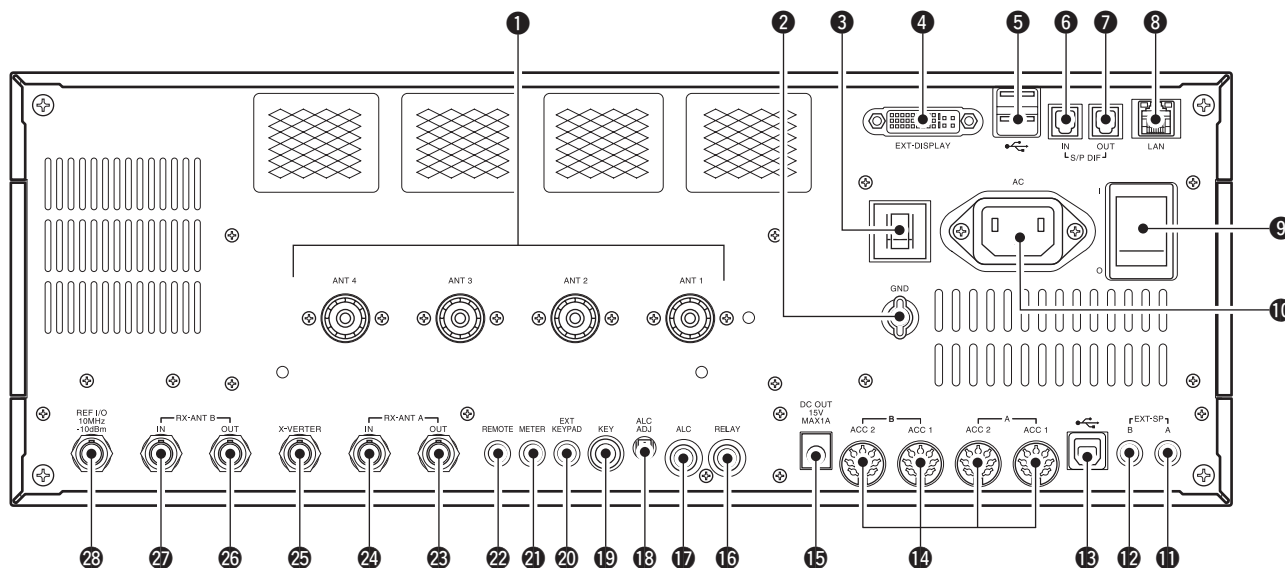

### ❶ ANTENNA CONNECTOR [ANT 1-4] (p. 3-4)

Connects to a 50 Ω antenna with a PL-259 plug connector.

### ❷ GROUND TERMINAL [GND] (p. 3-2)

Connect this terminal to ground to prevent electrical shocks, TVI, BCI and other problems.

### ❸ CIRCUIT BREAKER

Cuts off the AC input if excessive current flows.

### ❹ EXTERNAL DISPLAY TERMINAL [EXT-DISPLAY] (p. 3-6)

Connects to an external display monitor.

- At least 800×600 pixel display is necessary.

### ❺ USB (Universal Serial Bus) PORT [USB A]

- Connect an optional RC-28 remote encoder.
  - Insert a USB flash drive\* for both reading and storing a wide variety of the transceiver's information and data.
    - The indicator lights or blinks when the transceiver reads or writes to the memory data.
    - An unmount operation should be performed before removing the USB flash drive\*.
  - Connects to a PC keyboard for RTTY and PSK operations.
    - USB keyboards\* are supported.
- \*: A USB flash drive or USB keyboard is not supplied by Icom.

#### About the [USB A] connector:

- Supports only an RC-28, USB flash drive, keyboard, mouse, or hub.
- Turn the transceiver power OFF when connecting or disconnecting an RC-28, USB keyboard, mouse, or hub.
- **DO NOT** connect the following devices:
  - Two or more of the same kind of USB devices. (Example: Two USB hubs or two USB mice)
  - A Multimedia adapter
  - A USB HDD
  - A USB flash drive larger than 32 GB
  - A Bluetooth® keyboard or mouse.

### ❻ S/P DIF INPUT TERMINAL [S/P DIF- IN]

### ❼ S/P DIF OUTPUT TERMINAL [S/P DIF- OUT]

Connects to external equipment that supports S/P DIF input/output.

### ❽ ETHERNET CONNECTOR [LAN] (p. 3-6)

Connects to a PC network through a LAN (Local Area Network).

### ❾ MAIN POWER KEY [I/O] (p. 4-3)

Turns the internal power supply ON or OFF.

### ❿ AC POWER SOCKET [AC] (p. 3-4)

Connects the supplied AC power cable to an AC receptacle.

### ⓫ EXTERNAL SPEAKER JACK MAIN [EXT-SP A] (p. 3-5)

### ⓬ EXTERNAL SPEAKER JACK SUB [EXT-SP B] (p. 3-5)

Connects to an external speaker (4-8 Ω), if desired.



**13 USB PORT [USB B]**

USB B type port connects to a PC.  
 • A USB A-USB B cable is required.

**14 ACCESSORY SOCKET [A ACC1]  
 ACCESSORY SOCKET [A ACC2]  
 ACCESSORY SOCKET [B ACC1]  
 ACCESSORY SOCKET [B ACC2]**

Connects to external equipment such as a linear amplifier, an automatic antenna selector/tuner, a TNC for data communications, and so on.  
 • See page 20-2 for detailed socket information.

**15 DC OUTPUT JACK [DC OUT] (p. 20-5)**

Outputs regulated 14 V DC (approximately) for external equipment. Connected in parallel with 13.8 V outputs of [ACC 1] and [ACC 2]. (maximum 1 A in total)

**16 T/R CONTROL JACK [RELAY] (pp. 3-5, 20-4)**

Goes to ground when transmitting to control an external unit, such as a non-Icom linear amplifier.

**NOTE:** T/R control voltage and current must be lower than 16 V DC/0.5 A (or 250 V AC, 200 mA with MOS-FET switching).

**17 ALC INPUT JACK [ALC] (p. 3-5)**

Connects to the ALC output jack of a non-Icom linear amplifier.

**18 ALC LEVEL ADJUSTMENT POT [ALC ADJ]**

Rotate to adjust the ALC levels.  
 No adjustment is required when the ALC output level of the connected non-Icom linear amplifier is 0 to -4 V DC.

**19 STRAIGHT KEY JACK [KEY] (p. 20-3)**

Connects to a straight key or external electronic keyer with 1/4 inch standard plug.  
 • [ELEC-KEY] on the front panel can be used for a straight key or external electronic keyer. Deactivate the internal electronic keyer in the Keyer set screen. (p. 5-13)

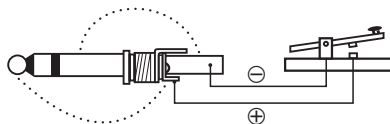
**20 EXTERNAL KEYPAD JACK [EXT KEYPAD]  
 (p. 20-4)**

Connects to an external keypad for direct voice memory (p. 9-11), memory keyer (p. 5-10), RTTY memory (p. 5-17) or PSK memory (p. 5-29) transmission.  
 A transceiver mute control line (both transmit and receive) is also supported.

**21 METER JACK [METER] (p. 20-5)**

Outputs the received signal strength, transmit output power, VSWR, ALC, speech compression, Vd or Id levels for an external meter.

**22 CI-V REMOTE CONTROL JACK [REMOTE]  
 (p. 20-5)**

➔ Connects to a PC through the optional CT-17 CI-V LEVEL CONVERTER for external control of the transceiver.  
 ➔ Used for transceive operation with another Icom CI-V transceiver or receiver.

**23 RECEIVE ANTENNA A OUT [RX ANT A- OUT]****24 RECEIVE ANTENNA A IN [RX ANT A- IN]**

Located between the transmit/receive switching circuit and the receiver's RF stage in the Sub band (Main band in the split frequency mode).

Connects to an external unit, such as preamplifier or RF filter, using BNC connectors, if desired.

When no external unit is connected, [RX ANT A- IN] and [RX ANT A- OUT] must be deactivated and internally shorted by the switching relay. This setting is available in the ANT screen. (p. 13-6)

**25 TRANSVERTER CONNECTOR [X-VERTER]  
 (p. 20-4)**

Connects to an external transverter for input/output.  
 Activated by a voltage applied to [ACC 2] pin 6, or when the transverter function is in use. (pp. 20-2, 15-14)

**26 RECEIVE ANTENNA B OUT [RX ANT B- OUT]****27 RECEIVE ANTENNA B IN [RX ANT B- IN]**

Located between the transmit/receive switching circuit and receiver's RF stage in the Main band (Sub band during split operation).

Connects an external unit, such as preamplifier or RF filter, using BNC connectors, if desired.

When no external unit is connected, [RX ANT B- IN] and [RX ANT B- OUT] must be deactivated and internally shorted by the switching relay. This setting is available in the ANT screen. (p. 13-6)

**28 REFERENCE SIGNAL INPUT/OUTPUT  
 TERMINAL [REF I/O]**

Input or output for a 10 MHz reference signal.

## ■ Display

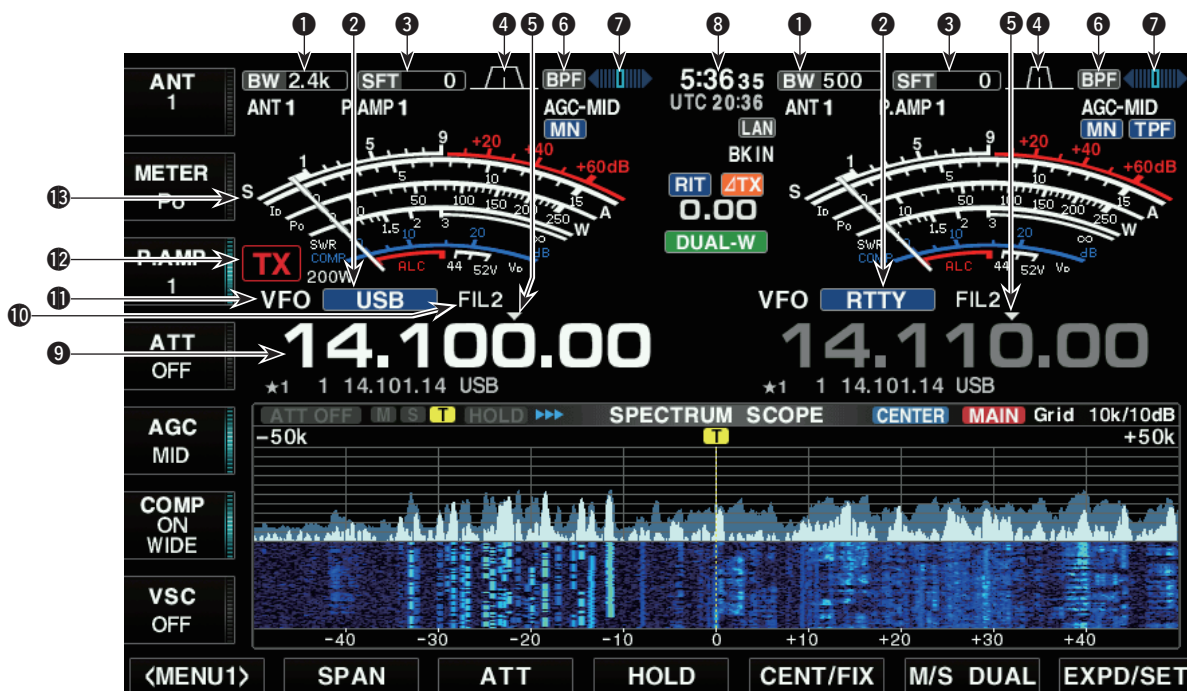

**1 BAND WIDTH INDICATOR** (p. 7-5)

Displays the passband width of the IF filter.

**2 MODE INDICATOR**

Displays the selected mode.

**3 SHIFT FREQUENCY INDICATOR** (p. 7-5)

Displays the shift frequency of the IF filter.

**4 PASSBAND WIDTH INDICATOR** (p. 7-5)

Graphically displays the passband width for twin PBT operation and the center frequency for IF shift operation.

**5 QUICK TUNING INDICATOR** (p. 4-7)

Appears when the Quick Tuning step function is ON.

**6 BANDPASS FILTER INDICATOR**

Appears when the narrow filter (500 Hz or less) is selected in the CW, RTTY, or PSK mode.

**7 RTTY TUNING INDICATOR**

Displays the tuning level in the RTTY mode.

**8 CLOCK READOUT**

Displays the current time.

**9 FREQUENCY READOUTS**

Displays the operating frequency.

- Gray characters are used for a non-active frequency.

**10 IF FILTER INDICATOR**

Displays the selected IF filter number.

**11 VFO/MEMORY CHANNEL INDICATOR** (p. 4-5)

Indicates the VFO mode or selected memory channel number.

**12 TX ICON**

- “TX” appears while transmitting.
- Indicates the frequency used for transmit.
  - Displays on the Sub readout when the split function is turned ON.
  - A TX icon with dotted rectangle, “TX” is displayed, instead of the regular “TX” TX icon, when a frequency outside of an amateur band frequency range is selected. This function can be turned OFF in the Others set screen, if desired. (p. 4-5)

**13 S/R/F METER** (p. 4-11)

Displays the signal strength while receiving. Displays the relative output power, SWR, ALC or compression levels while transmitting.

■ Display (Continued)

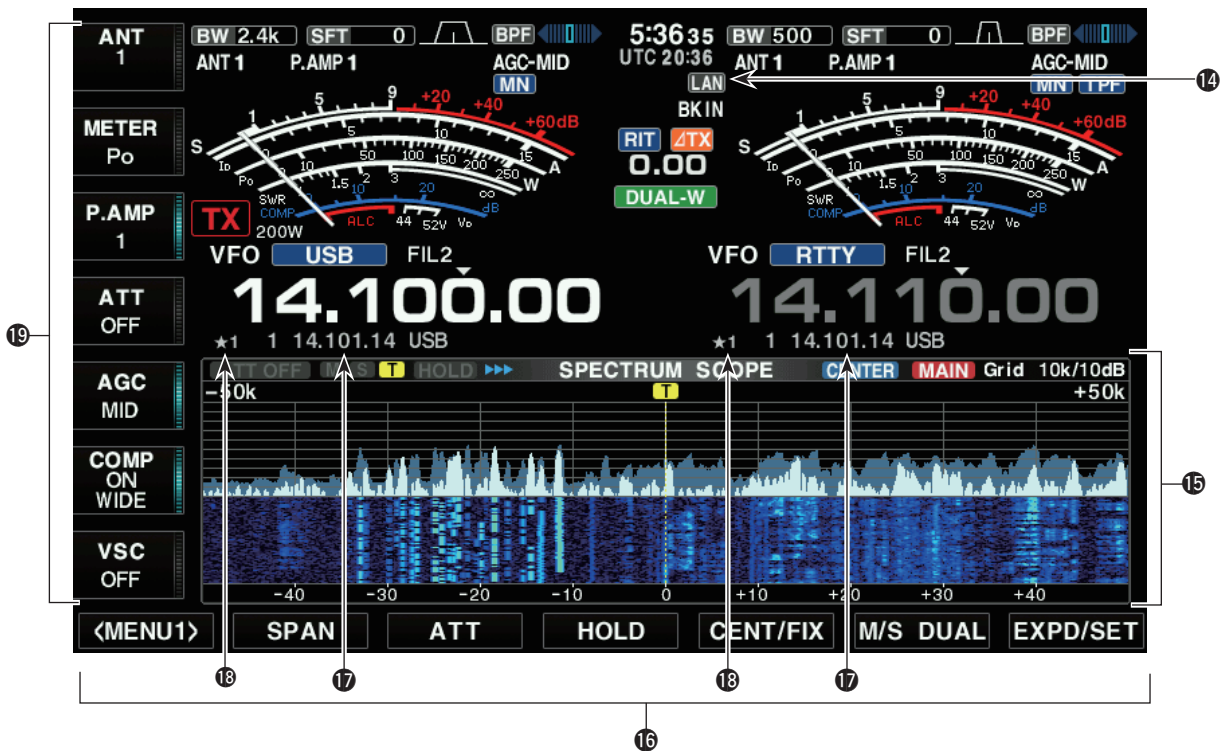

**14 LAN INDICATOR**

Displays when the Remote station accesses the transceiver through the LAN connector. (An optional RS-BA1 is required.)

**15 MULTI-FUNCTION SCREEN**

Display screen for the Digital multi-function meter, Spectrum scope, Audio scope, Voice recorder, Memory channel, Scan, Memory keyer, RTTY decoder, PSK decoder, IF filter selection, and Set modes.

**16 DISPLAY FUNCTION KEY GUIDE**

Indicates the current function of the Display Function keys ([F-1] – [F-7]).

**17 MEMORY CHANNEL READOUTS**

- ➔ Displays the selected memory channel contents in the VFO mode.
- ➔ Displays the VFO contents in memory mode.

**18 SELECT MEMORY CHANNEL INDICATOR (p. 12-7)**

Indicates the displayed memory channel that is assigned as a Select memory channel. The desired memory channels can be assigned to 3 select groups, for fast, convenient scanning.

**19 MULTI-FUNCTION KEY GUIDE**

Displays the function of the Multi-function keys.

# 1 PANEL DESCRIPTION

## Screen menu arrangement

The following screens can be selected from the Start up screen. Choose the desired screen using the following guide.

### • Start up screen



### • Spectrum scope screen (p. 6-2)



### • Voice recorder screen (p. 9-3)



### • Memory keyer screen (CW mode: p. 5-10)

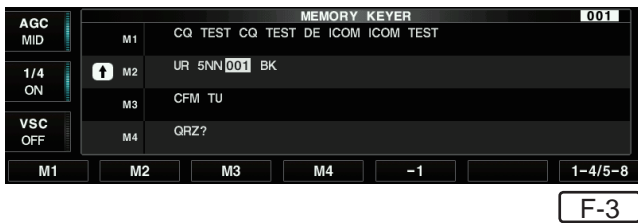

### • RTTY decode screen (p. 5-16)



Pushing [EXIT/SET] several times returns to the Start up screen. See page 15-3 for set mode arrangement.

### • PSK decode screen (p. 5-26)



### • Memory channel screen (p. 11-3)

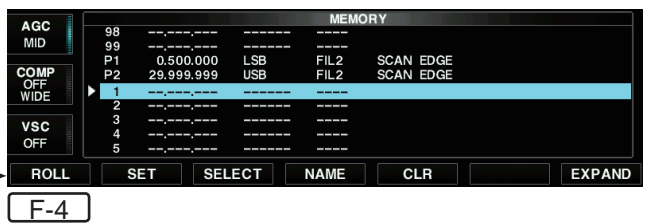

### • Scan screen (VFO mode: p. 12-5)

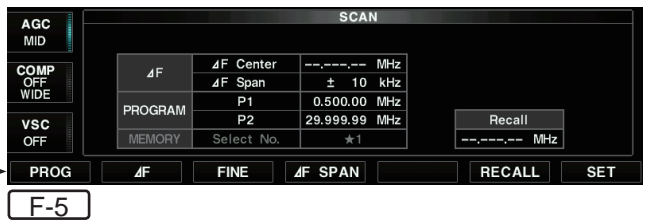

### • Scan screen (Memory mode: p. 12-7)

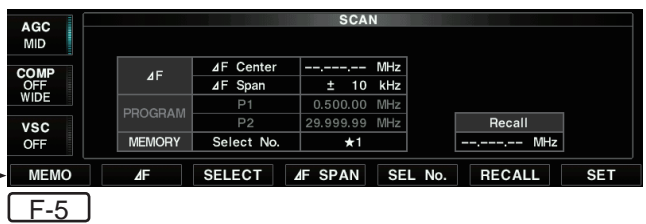

### • Audio scope screen (p. 6-15)

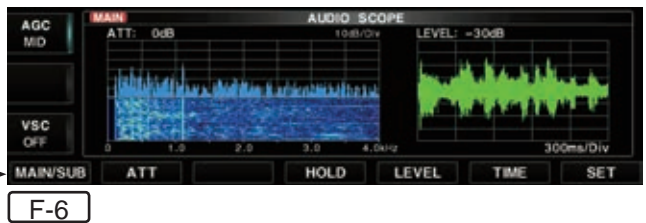

### • Set mode menu screen (p. 15-3)

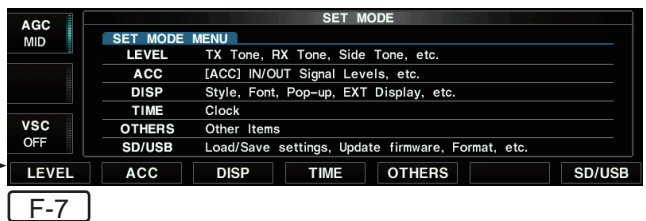

---

■ About the Setting screen configuration .....	2-2
■ SCOPE SET .....	2-3
■ VOICE SET .....	2-4
■ KEYSER 001 .....	2-4
■ KEYSER CW-KEY .....	2-5
■ RTTY LOG SET .....	2-5
■ RTTY DECODE SET .....	2-5
■ PSK LOG SET .....	2-6
■ PSK DECODE SET .....	2-6
■ SCAN SET .....	2-6
■ AUDIO SCOPE SET .....	2-6
■ LEVEL SET .....	2-7
■ ACC SET .....	2-8
■ DISPLAY SET .....	2-10
■ TIME SET .....	2-11
■ OTHERS SET .....	2-11
■ LOAD SET .....	2-16
■ SAVE SET .....	2-16
■ ANT TYPE .....	2-16
■ VOX .....	2-17
■ NB.....	2-17
■ FILTER SHAPE SET .....	2-17

## ■ About the Setting screen configuration

The transceiver Setting consists of the following items.

SETTING SCREEN			REF.	
SPECTRUM SCOPE	SCOPE SET		pp. 2-3, 6-10	
VOICE MEMORY	VOICE SET		pp. 2-4, 9-13	
MEMORY KEYER	KEYER 001		pp. 2-4, 5-12	
	KEYER CW-KEY		pp. 2-5, 5-13	
RTTY DECODE	RTTY LOG SET		pp. 2-5, 5-20	
	RTTY DECODE SET		pp. 2-5, 5-22	
PSK DECODE	PSK LOG SET		pp. 2-6, 5-32	
	PSK DECODE SET		pp. 2-6, 5-34	
SCAN	SCAN SET		pp. 2-6, 12-3	
AUDIO SCOPE	AUDIO SCOPE SET		pp. 2-6, 6-16	
SET MODE	LEVEL SET		pp. 2-7, 15-4	
	ACC SET		pp. 2-8, 15-6	
	DISPLAY SET		pp. 2-10, 15-10	
	TIME SET		pp. 2-11, 15-12	
	OTHERS SET		pp. 2-11, 15-13	
	SD/USB-MEMORY SET	SETTING LOAD	LOAD SET	pp. 2-16, 10-9
		SETTING SAVE	SAVE SET	pp. 2-16, 10-10
		CAPTURE LIST		—
		FIRMWARE UPDATE		p. 17-4
FORMAT		p. 10-6		
UNMOUNT		p. 10-7		
ANT	ANT TYPE		pp. 2-16, 13-4	
VOX			pp. 2-17, 8-3	
NB			pp. 2-17, 7-11	
FILTER	FILTER SHAPE SET		pp. 2-17, 7-9	



## ■ SCOPE SET

### SCOPE [F-1] ▾ EXPD/SET [F-7]

ITEMS	DESCRIPTIONS	RANGE OR VALUE	REF.
Scope during Tx (CENTER Type)	Transmit signal spectrum indication setting.	OFF, ON	p. 6-10
Max Hold	Peak level holding function setting.	OFF, 10s Hold, ON	
CENTER Type Display	Center frequency setting when using the Center type scope.	Filter Center, Carrier Point Center, Carrier Point Center (Abs. Freq.)	
Marker Position (FIX Type)	Marker position setting when using the Fixed type scope.	Filter Center, Carrier Point	
VBW	Video band width setting.	Narrow, Wide	
Averaging	Averaging function setting for the spectrum scope.	OFF, 2, 3, 4	
Waveform Type	Spectrum display type setting.	Fill, Fill+Line	p. 6-11
Waveform Color (Current)	Spectrum fill color setting.	0~255 (in 1 digit steps)	
Waveform Color (Line)	Spectrum outline color setting.	0~255 (in 1 digit steps)	
Waveform Color (Max Hold)	Spectrum color setting for peak hold.	0~255 (in 1 digit steps)	
Waterfall Display	Waterfall setting for spectrum scope.	OFF, ON	
Waterfall Speed	Waterfall speed setting.	SLOW, MID, FAST	
Waterfall Size (Expand Scope)	Waterfall height setting while using the expanded scope screen is displayed.	Small, Mid, Large	
Waterfall Peak Color Level	Waterfall color level setting.	Grid 1 ~ Grid 10	
Waterfall Marker Auto-hide	The marker in the Waterfall zone is hidden 2 seconds after you have stopped it in place.	OFF, ON	
Dual Scope Type	Main and Sub scope screen arrangement during dual scope.	Over/Under, Side by Side	
Dual Scope Auto Select	Main/Sub scope screen access setting linked to the [MAIN]/[SUB] key operation.	OFF, ON	p. 6-12
Fixed Edges (0.03 – 1.60)	Scope edge frequencies settings when using the Fixed type scope. Up to 3 types can be set to each band.	0.030 MHz ~ 1.600 MHz	
Fixed Edges (1.60 – 2.00)		1.600 MHz ~ 2.000 MHz	
Fixed Edges (2.00 – 6.00)		2.000 MHz ~ 6.000 MHz	
Fixed Edges (6.00 – 8.00)		6.000 MHz ~ 8.000 MHz	
Fixed Edges (8.00 – 11.00)		8.000 MHz ~ 11.000 MHz	
Fixed Edges (11.00 – 15.00)		11.000 MHz ~ 15.000 MHz	
Fixed Edges (15.00 – 20.00)		15.000 MHz ~ 20.000 MHz	
Fixed Edges (20.00 – 22.00)		20.000 MHz ~ 22.000 MHz	p. 6-13
Fixed Edges (22.00 – 26.00)		22.000 MHz ~ 26.000 MHz	
Fixed Edges (26.00 – 30.00)		26.000 MHz ~ 30.000 MHz	
Fixed Edges (30.00 – 45.00)	30.000 MHz ~ 45.000 MHz		
Fixed Edges (45.00 – 60.00)		45.000 MHz ~ 60.000 MHz	

## VOICE SET

VOICE [F-2] ▸ SET [F-7]

ITEMS	DESCRIPTIONS	RANGE OR VALUE	REF.
VOICE 1st Menu	Root screen selection that displays first after [VOICE](F) is pushed.	VOICE-Root, VOICE-TX	p. 9-13
VOICE TX Auto Monitor	Automatic monitor function setting when transmitting a voice memory recording.	OFF, ON	
VOICE TX Repeat Time	Interval setting for the voice repeat transmission.	1 ~ 15 seconds (in 1 second steps)	
QSO REC Storage Media	Storage media selection for the QSO recorder.	SD CARD, USB-Memory	
QSO REC REC Mode	Recording mode selection for the QSO recorder.	TX&RX, RX Only	
QSO REC TX REC Audio	Recording TX audio selection for the QSO recorder.	Direct, Monitor	
QSO REC RX REC Condition	The squelch relation setting to record RX audio for the QSO recorder.	Always, Squelch Auto	
QSO REC File Split	The file split function setting.	OFF, ON	p. 9-14
QSO REC PTT Auto REC	The PTT Automatic Recording function setting.	OFF, ON	
QSO REC PRE-REC for PTT Auto REC	RX audio recording status setting for the PTT Automatic Recording function.	OFF, 5, 10, 15 seconds	
QSO PLAY Skip Time	Skip time setting for both forwarding and re-winding during QSO player operation.	3, 5, 10, 30 seconds	
INSTANT REPLAY REC Time	Instant record time setting when [REC] is pushed.	5 ~ 30 seconds (in 1 second steps)	
INSTANT REPLAY Play Time	Instant playback time setting when [PLAY] is pushed.	3 ~ 10 seconds (in 1 second steps)	

## KEYER 001

KEYER [F-3] ▸ [EXIT/SET] ▸ 001 [F-3]

ITEMS	DESCRIPTIONS	RANGE OR VALUE	REF.
Number Style	Contest (serial) numbering system setting.	Normal, 190→ANO, 190→ANT, 90→NO, 90→NT	p. 5-12
Count Up Trigger	Count up trigger channel selection.	M1, M2, M3, M4, M5, M6, M7, M8	
Present Number	Present Number setting.	001 ~ 9999 (in 1 steps)	



## ■ KEYER CW-KEY

KEYER [F-3] ▾ [EXIT/SET] ▾ CW KEY [F-4]

ITEMS	DESCRIPTIONS	RANGE OR VALUE	REF.
Keyer Repeat Time	Interval setting for the memory keyer transmission repeat.	1 ~ 60 seconds (in 1 second steps)	p. 5-13
Dot/Dash Ratio	Dot/Dash ratio setting for ELE-KEY.	1:1:2.8 ~ 1:1:4.5 (in 0.1 steps)	
Rise Time	Rise time of the transmitting CW envelope setting.	2, 4, 6, 8 milliseconds	
Paddle Type	Paddle polarity setting.	Normal, Reverse	
Keyer Type	Keyer type setting for the keyer which is connected to [ELEC-KEY] on the front panel.	Straight, BUG-KEY, ELEC-KEY	
MIC Up/Down Keyer	Microphone [UP]/[DN] keys to be used as a paddle setting.	OFF, ON	

## ■ RTTY LOG SET

DECODE [F-3] ▾ <MENU1> [F-1] ▾ LOG [F-4]

ITEMS	DESCRIPTIONS	RANGE OR VALUE	REF.
RTTY Log	RTTY log use.	OFF, ON	p. 5-20
RTTY Log File Type	RTTY log file saving format selection.	Text, HTML	
RTTY Log Storage Media	Storage media selection for saving an RTTY log file.	SD CARD, USB-Memory	

## ■ RTTY DECODE SET

DECODE [F-3] ▾ <MENU1> [F-1] ▾ SET [F-6]

ITEMS	DESCRIPTIONS	RANGE OR VALUE	REF.
RTTY FFT Scope Averaging	RTTY FFT scope averaging function setting.	OFF, 2, 3, 4	p. 5-22
RTTY FFT Scope Waveform Color	RTTY FFT scope waveform color setting.	0~255 (in 1 digit steps)	
RTTY Decode USOS	RTTY decode USOS (UnShift On Space) function setting.	OFF, ON	
RTTY Decode New Line Code	RTTY internal decoder new line code setting.	CR, LF, CR+LF, CR+LF	
RTTY Diddle	RTTY diddle setting.	OFF, BLANK, LTRS	
RTTY TX USOS	RTTY TX USOS setting.	OFF, ON	
RTTY Auto CR+LF by TX	RTTY automatic new line code (CR+LF) transmission setting.	OFF, ON	p. 5-23
RTTY Time Stamp	RTTY decode screen Time stamp setting.	OFF, ON	
RTTY Time Stamp (Time)	Clock selection for the RTTY time stamp.	Local, UTC	
RTTY Time Stamp (Frequency)	Frequency information stamp setting for the RTTY time stamp.	OFF, ON	
RTTY Font Color (Receive)	Text color setting for the received characters.	0~255 (in 1 digit steps)	
RTTY Font Color (Transmit)	Text color setting for the transmitted characters.	0~255 (in 1 digit steps)	
RTTY Font Color (Time Stamp)	Text color setting for the time stamp.	0~255 (in 1 digit steps)	
RTTY Font Color (TX Buffer)	Text color setting in the TX buffer screen.	0~255 (in 1 digit steps)	

## ■ PSK LOG SET

DECODE [F-3] ▾ <MENU1> [F-1] ▾ LOG [F-4]

ITEMS	DESCRIPTIONS	RANGE OR VALUE	REF.
PSK Log	PSK log use.	OFF, ON	p. 5-32
PSK Log File Type	PSK log file saving format selection.	Text, HTML	
PSK Log Storage Media	Storage media selection for saving a PSK log file.	SD CARD, USB-Memory	

## ■ PSK DECODE SET

DECODE [F-3] ▾ <MENU1> [F-1] ▾ SET [F-6]

ITEMS	DESCRIPTIONS	RANGE OR VALUE	REF.
PSK FFT Scope Averaging	PSK FFT scope averaging function setting.	OFF, 2, 3, 4	p. 5-34
PSK FFT Scope Waveform Color	PSK FFT scope waveform color setting.	0~255 (in 1 digit steps)	
PSK AFC Range	PSK AFC (Automatic Frequency Control) function's functioning range setting.	±15Hz, ±8Hz	
PSK Time Stamp	Time stamp setting on the PSK decode screen.	OFF, ON	
PSK Time Stamp (Time)	Clock selection for the PSK time stamp.	Local, UTC	
PSK Time Stamp (Frequency)	Frequency information stamp setting for PSK time stamp.	OFF, ON	
PSK Font Color (Receive)	Text color setting for the received characters.	0~255 (in 1 digit steps)	p. 5-35
PSK Font Color (Transmit)	Text color setting for the transmitted characters.	0~255 (in 1 digit steps)	
PSK Font Color (Time Stamp)	Text color setting for the time stamp.	0~255 (in 1 digit steps)	
PSK Font Color (TX Buffer)	Text color setting in the TX buffer screen.	0~255 (in 1 digit steps)	

## ■ SCAN SET

SCAN [F-5] ▾ SET [F-7]

ITEMS	DESCRIPTIONS	RANGE OR VALUE	REF.
SCAN Speed	Scan speed setting.	LOW, HIGH	p. 12-3
SCAN Resume	Scan resume function setting.	OFF, ON	

## ■ AUDIO SCOPE SET

AUDIO [F-6] ▾ SET [F-7]

ITEMS	DESCRIPTIONS	RANGE OR VALUE	REF.
FFT Scope Waveform Type	Waveform type setting for the FFT audio scope.	Fill, Line	p. 6-16
FFT Scope Waveform Color	Waveform color setting for the FFT audio scope.	0~255 (in 1 digit steps)	
FFT Scope Waterfall Display	Waterfall setting for the FFT audio scope.	OFF, ON	
Oscilloscope Waveform Color	Waveform color setting for the Oscilloscope.	0~255 (in 1 digit steps)	

## LEVEL SET

SET [F-7] ▸ LEVEL [F-1]

ITEMS	DESCRIPTIONS	RANGE OR VALUE	REF.	
SSB RX HPF/LPF	HPF (High-Pass Filter)/LPF (Low-Pass Filter) cut-off frequency setting for the received audio in SSB mode.	HPF 100Hz ~ 2000Hz LPF 500Hz ~ 2400Hz	p. 15-4	
SSB RX Tone (Bass)	RX Tone level setting for SSB.	Bass		
SSB RX Tone (Treble)		Treble		
AM RX HPF/LPF	HPF (High-Pass Filter)/LPF (Low-Pass Filter) cut-off frequency setting for the received audio in AM mode.	HPF 100Hz ~ 2000Hz LPF 500Hz ~ 2400Hz		
AM RX Tone (Bass)	RX Tone level setting for AM.	Bass		
AM RX Tone (Treble)		Treble		
FM RX HPF/LPF	HPF (High-Pass Filter)/LPF (Low-Pass Filter) cut-off frequency setting for the received audio in FM mode.	HPF 100Hz ~ 2000Hz LPF 500Hz ~ 2400Hz		
FM RX Tone (Bass)	RX Tone level setting for FM.	Bass		
FM RX Tone (Treble)		Treble		
CW RX HPF/LPF	HPF (High-Pass Filter)/LPF (Low-Pass Filter) cut-off frequency setting for the reception.	HPF 100Hz ~ 2000Hz LPF 500Hz ~ 2400Hz		
RTTY RX HPF/LPF				
PSK RX HPF/LPF				
SSB TX Tone (Bass)	TX Tone level setting.	Bass	-5~+5 (in 1 digit steps)	
SSB TX Tone (Treble)		Treble		
AM TX Tone (Bass)		Bass		
AM TX Tone (Treble)		Treble		
FM TX Tone (Bass)		Bass		
FM TX Tone (Treble)		Treble		
SSB TBW (WIDE)		Transmission passband width setting for the "WIDE" selection.		Lower freq. : 100, 200, 300 and 500 Hz Higher freq. : 2500, 2700, 2800 and 2900 Hz
SSB TBW (MID)		Transmission passband width setting for the "MID" selection.		
SSB TBW (NAR)	Transmission passband width setting for the "NAR" selection.			
SSB-D TBW	Transmission passband width setting for the SSB-D mode.			
Speech Level	Voice synthesizer audio output level setting.	0~100% (in 1% steps)		
Side Tone Level	CW side tone output level setting.	0~100% (in 1% steps)		
Side Tone Level Limit	CW side tone output level limit function setting.	OFF, ON		
APF AF Level	Audio output level setting while APF is used.	0~+6 dB (in 1dB steps)		
Beep Level	Beep audio output level setting.	0~100% (in 1% steps)		
Beep Level Limit	Sets the limit of the beep output level.	OFF, ON		
Phones Level	Ratio setting for audio output level from the headphone toward to the internal speaker.	-15~+15 (in 1 digit steps)		
Phone L/R Mix	Main/Sub bands audio mix output setting to the headphone.	OFF, ON		

p. 15-5

## ■ ACC SET

SET [F-7] ▾ ACC [F-2]

ITEMS	DESCRIPTIONS	RANGE OR VALUE	REF.
ACC-A AF/SQL Output Select	[A ACC1]	Band selection for the AF/SQL signal output.	MAIN, SUB
ACC-B AF/SQL Output Select	[B ACC1]		
ACC-A Output Select	[A ACC1]	Output signal setting.	AF, IF
ACC-A AF/IF XFC Output (SPLIT ON)		Band selection for the AF/IF signal output while holding down [XFC] during the split operation.	MAIN, SUB
ACC-A AF Output Level		AF Output Level setting.	0~100% (in 1% steps)
ACC-A AF SQL		Squelch relation setting when AF signal output is set.	OFF(OPEN), ON
ACC-A AF Beep/Speech... Output		Beep and voice synthesizer audio output setting when the AF signal output is set.	OFF, ON
ACC-A IF Output Level		IF Output Level setting.	0~100% (in 1% steps)
ACC-B Output Select		[B ACC1]	Output signal setting.
ACC-B AF/IF XFC Output (SPLIT ON)	Band selection for the AF/IF signal output while holding down [XFC] during split operation.		MAIN, SUB
ACC-B AF Output Level	AF Output Level setting		0~100% (in 1% steps)
ACC-B AF SQL	Squelch relation setting when the AF signal output is set.		OFF(OPEN), ON
ACC-B AF Beep/Speech... Output	Beep and voice synthesizer audio output setting when the AF signal output is set.		OFF, ON
ACC-B IF Output Level	IF Output Level setting.		0~100% (in 1% steps)
S/PDIF Output Select	[S/P DIF]		Output signal setting.
S/PDIF AF/IF XFC Output (SPLIT ON)		Band selection for the AF/IF signal output while holding down [XFC] during split operation.	MAIN, SUB
S/PDIF AF Output Level		AF Output Level setting.	0~100% (in 1% steps)
S/PDIF AF SQL		Squelch relation setting when the AF signal output is set.	OFF(OPEN), ON
S/PDIF AF Beep/Speech... Output		Beep and voice synthesizer audio output setting when the AF signal output is set.	OFF, ON
S/PDIF IF Output Level		IF Output Level setting.	0~100% (in 1% steps)

## ■ ACC SET(Continued)

SET [F-7] ▾ ACC [F-2]				
ITEMS	DESCRIPTIONS		RANGE OR VALUE	REF.
USB Output Select	[USB B]	Output signal setting.	AF, IF	p. 15-7
USB AF/IF XFC Output (SPLIT ON)		Band selection for the AF/IF signal output while holding down [XFC] during split operation.	MAIN, SUB	
USB AF Output Level		AF Output Level setting.	0~100% (in 1% steps)	
USB AF SQL		Squelch relation setting when the AF signal output is set.	OFF(OPEN), ON	
USB AF Beep/Speech... Output		Beep and voice synthesizer audio output setting when the AF signal output is set.	OFF, ON	
USB IF Output Level		IF Output Level setting.	0~100% (in 1% steps)	p. 15-8
LAN Output Select	[LAN]	Output signal setting.	AF, IF	
LAN AF SQL		Squelch relation setting when the AF signal output is set.	OFF(OPEN), ON	
ACC-A MOD Level	[A ACC1]	Modulation signal input level.	0~100% (in 1% steps)	
ACC-B MOD Level	[B ACC1]			
S/PDIF MOD Level	[S/P DIF]			
USB MOD Level	[USB B]			
LAN MOD Level	[LAN]			
DATA OFF MOD	Modulation input connector selection.	When data mode is not in use.	MIC, ACC-A, ACC-B, MIC, ACC-A, MIC, ACC-B, ACC-A, ACC-B, MIC, ACC-A, ACC-B, S/PDIF, USB, LAN, MIC, USB	p. 15-9
DATA1 MOD		When data 1 mode (D1) is in use.		
DATA2 MOD		When data 2 mode (D2) is in use.		
DATA3 MOD		When data 3 mode (D3) is in use.		
ACC-A BAND Voltage Output	[A ACC2]	Band selection for the band control signal.	MAIN, SUB, TX	
ACC-B BAND Voltage Output	[B ACC2]			
SEND Relay Type	SEND relay type setting.		Reed, MOS-FET	
External Meter Output (M)	Output signal setting from [METER].	MAIN	Auto, S(MAIN), Po, SWR, ALC, COMP, VD, ID	p. 15-10
External Meter Output (S)		SUB		
External Meter Level (M)		MAIN	0~100% (in 1% steps)	
External Meter Level (S)		SUB		
REF IN/OUT		[REF I/O]	Transceiver's reference signal status setting.	
REF Adjust	Internal reference signal frequency adjustment.		0~100% (in 1% steps)	

## ■ DISPLAY SET

SET [F-7] ▾ DISP [F-3]

ITEMS	DESCRIPTIONS	RANGE OR VALUE	REF.
LCD Unit Bright	LCD unit brightness setting.	0 (dark) to 100% (bright) range (in 1% steps)	p. 15-10
Backlight (Switches)	Switch illumination brightness setting.		
Display Type	Screen image type setting.	A, B, 50th Anniversary (Only IC-7850)	
Display Font	Frequency readout font setting.	Basic (1), Basic (2), Basic (3), Italic (1), Italic (2), Italic (3), Round (1), Round (2), Round (3)	
Meter Response	Standard and Edgewise meter needle response speed setting.	SLOW, MID, FAST	
Meter Type (Normal Screen)	Meter type setting during normal screen.	Standard, Edgewise, Bar	
Meter Type (Expand Screen)	Meter type setting during expanded screen or mini scope is displayed.	Edgewise, Bar	
Meter Peak Hold (Bar)	The meter peak hold function setting.	OFF, ON	
Memory Name	Memory name indication setting.	OFF, ON	
APF-Width Popup (APF OFF⇒ON)	Pop-up indication setting for the APF filter width selection.	OFF, ON	p. 15-11
MN-Q Popup (MN OFF⇒ON)	Pop-up indication setting for the manual notch filter width selection.	OFF, ON	
Screen Saver Function	Screen saver function setting.	OFF, 15, 30, 60 minutes	
Screen Saver Type	Screen saver type setting.	Bounce, Rotation, Twist, Sleep	
External Display	External monitor use.	OFF, ON	
External Display Resolution	Screen resolution setting for the external monitor.	800×480, 800×600	
External Display Frame Rate Shift	Frame rate shift setting for the external monitor.	OFF, ON	
External Display Sync Pulse	Synchronous pulse level setting for the external monitor.	L, H	
Opening Message	Opening message display setting.	OFF, ON	
My Call	Introductory text setting for the Opening screen.		

## ■ TIME SET

SET [F-7] ▾ TIME [F-4]

ITEMS	DESCRIPTIONS	RANGE OR VALUE	REF.
Date	Date setting.	Year 2000~2099, Month/Day 1- 1~12-31	p. 15-12
Time (Now)	Clock setting.	0:00~23:59	
NTP Function	NTP server client function setting.	OFF, ON	
NTP Server Address	NTP server address setting.		
UTC Offset	Offset time setting from the UTC.	-14:00~+14:00 (in 5 minute steps)	
CLOCK2 Function	Clock 2 indication setting.	OFF, ON	
CLOCK2 UTC Offset	Clock 2 Offset time setting.	-14:00~±0:00~+14:00	
CLOCK2 Name	Clock 2 name setting.	Up to 3 characters	

## ■ OTHERS SET

SET [F-7] ▾ OTHERS [F-5]

ITEMS	DESCRIPTIONS	RANGE OR VALUE	REF.
Calibration Marker	Calibration marker setting.	OFF, ON	p. 15-13
Beep (Confirmation)	Confirmation beep setting.	OFF, ON	
Beep (Band Edge)	Band edge beep setting.	OFF, ON (Default), ON (User), ON (User) & TX Limit	
Beep Sound (MAIN)	Confirmation beep audio frequency setting.	500 ~2000 Hz (in 10Hz steps)	
Beep Sound (SUB)			
TX Power Limit	Transmit output power limit function setting.	OFF, ON	
TX Delay (HF)	HF bands	TX delay time setting for the liner amplifier opera- tion.	
TX Delay (50M)	50 MHz band		
Time-Out Timer (CI-V)	Time-Out Timer function setting for the re- mote or the [TRANSMIT] key operation.	OFF, 3, 5, 10, 20, 30 minutes	
Quick Dualwatch	Quick Dualwatch function setting.	OFF, ON	
Quick SPLIT	Quick SPLIT function setting.	OFF, ON	
FM SPLIT Offset (HF)	HF bands	Offset frequency setting for the Quick SPLIT func- tion.	p. 15-14
FM SPLIT Offset (50MHz)	50 MHz band		
SPLIT LOCK	Split Lock function setting.	OFF, ON	
Tuner (Auto Start)	Automatic tuning start function setting for the HF bands.	OFF, ON	
Tuner (PTT Start)	Automatic tuning start function with PTT setting.	OFF, ON	
Tuner Preset Memory Clear	Antenna selection for the tuner preset mem- ory clearing.	ANT1, ANT2, ANT3, ANT4, ALL	

## 2 SET MODE ITEMS

### ■ OTHERS SET(Continued)

#### SET [F-7] ▾ OTHERS [F-5]

ITEMS	DESCRIPTIONS	RANGE OR VALUE	REF.	
Transverter Function	Transverter function setting.	ON, Auto	p. 15-14	
Transverter Offset	Offset frequency setting for the transverter operation.	0.000 to 99.999 MHz (in 1 kHz steps)		
RTTY Mark Frequency	RTTY mark frequency setting.	1275, 1615, 2125 (Hz)		
RTTY Shift Width	RTTY shift width setting.	170, 200, 425 (Hz)		
RTTY Keying Polarity	RTTY keying polarity setting.	Normal, Reverse		
PSK Tone Frequency	PSK tone frequency setting.	1000, 1500, 2000 (Hz)		
SPEECH Language	Speech language setting for the voice synthesizer.	English, Japanese		
SPEECH Speed	Speech speed setting for the voice synthesizer.	LOW, HIGH		
SPEECH S-Level	S-Level announcement setting for the voice synthesizer.	OFF, ON		
SPEECH [MODE] Switch	Operating mode speech setting when a mode switch is pushed.	OFF, ON		p. 15-15
Memo Pad Quantity	Number of memo pad channel setting.	5, 10		
MAIN DIAL Operation	[MAIN DIAL] accessible band setting.	MAIN, MAIN/SUB		
MAIN DIAL Auto TS	Automatic tuning step function setting for [MAIN DIAL].	OFF, LOW, HIGH		
SUB DIAL Auto TS	Automatic tuning step function setting for [SUB DIAL].			
MAIN/SUB Tracking [MAIN] SW	Assigns the Main/Sub band tracking function to the [MAIN] key.	OFF, ON		
MIC Up/Down Speed	Rate setting for frequency change when the microphone's [UP]/[DN] switches are held down.	LOW, HIGH		
Quick RIT/ΔTX Clear	RIT/ΔTX frequency quick clearing function setting.	OFF, ON		
[NOTCH] Switch (SSB)	for SSB mode	Selectable notch type setting.	Auto, Manual, Auto/Manual	
[NOTCH] Switch (AM)	for AM mode			
DIGI-SEL VR Operation	Controllable function setting for the [DIGI-SEL] control.	DIGI-SEL, APF		
FILTER Screen MAIN/SUB Select	FILTER Screen MAIN/SUB band select setting.	Fix, Auto (by FILTER,PBT Operation)	p. 15-16	
SSB/CW Synchronous Tuning	Displayed frequency shift setting when operating mode is toggled between SSB and CW.	OFF, ON		



■ OTHERS SET(Continued)

SET [F-7] ▾ OTHERS [F-5]				
ITEMS	DESCRIPTIONS		RANGE OR VALUE	REF.
CW Normal Side	Carrier point setting for the CW mode operation.		LSB, USB	p. 15-16
APF Type	Audio filter shape setting for APF.		SOFT, SHARP	
MIC AF Out	Band selection for audio output from [MIC] (pin 8).		MAIN+SUB, SUB	
MIC Input DC Bias	Bias voltage setting for modulation input line ([MIC] pin 1).		OFF, ON	
External Keypad (VOICE)	[EXT KEYPAD] (rear panel), or [MIC] (front panel)	Voice memory transmission setting for an external keypad.	OFF, ON	
External Keypad (KEYER)		Memory keyer transmission setting for an external keypad.		
External Keypad (RTTY)		RTTY memory transmission setting for an external keypad.		
External Keypad (PSK)		PSK memory transmission setting for an external keypad.		
Keyboard [F1]–[F8] (VOICE)	[USB A] (rear panel)	Voice memory transmission for the connected keyboard ([F1]–[F8] keys).	OFF, ON	p. 15-17
Keyboard [F1]–[F8] (KEYER)		Memory keyer transmission for the connected keyboard ([F1]–[F8] keys).		
Screen Capture [POWER] SW	Assigns the Screen capture function to the [POWER] key.		OFF, ON	
Screen Capture Keyboard [Print Screen]	Assigns the Screen capture function to [Print Screen] key on the USB keyboard.			
Screen Capture Storage Media	Storage media setting for the captured screen image file to save.		SD CARD, USB-Memory	
Screen Capture Data Format	Saving file format setting for the captured screen image file.		PNG, BMP	
Shutdown Function	Shutdown option selection for the remote power control.		Shutdown, Standby/Shutdown	
CI-V Baud Rate	CI-V data transfer speed setting.		4800, 9600, 19200 (bps), Auto	
CI-V Address	Transceiver's address setting for the CI-V remote control.		02h~8Eh~DFh	p. 15-18
CI-V Transceive	Transceive function setting for the CI-V remote control.		OFF, ON	
CI-V USB/LAN→REMOTE Transceive Address	CI-V address setting for the 2nd transceiver or receiver controlled by the transceive function.		00h~DFh	

## 2 SET MODE ITEMS

### ■ OTHERS SET(Continued)

#### SET [F-7] ▾ OTHERS [F-5]

ITEMS	DESCRIPTIONS	RANGE OR VALUE	REF.
CI-V Output (for ANT)	Antenna controller Status data output setting.	OFF, ON	p. 15-18
CI-V USB Port	Link setting for CI-V signal line between [USB B] and [REMOTE].	Link to [REMOTE], Unlink from [REMOTE]	
CI-V USB Baud Rate	CI-V data transfer speed setting for the remote control through [USB B].	4800, 9600, 19200, 38400, 57600, 115200 (bps), Auto	
CI-V USB Echo Back	Echo back setting for the remote control through [USB B].	OFF, ON	
Decode Baud Rate	Decode data transfer speed setting for RTTY and PSK operation.	4800, 9600, 19200, 38400 (bps)	
USB SEND	Data line setting for the SEND control through [USB B].	OFF, USB1 DTR, USB1 RTS, USB2 DTR, USB2 RTS	
USB Keying (CW)	Data line setting for the CW keying control through [USB B].		
USB Keying (RTTY)	Data line setting for the RTTY (FSK) keying control through [USB B].		
USB SEND/Keying Inhibit at Connection	The timer to prevent unintentional SEND or Keying signal transmission	OFF, ON	
Keyboard Type	Language setting for the keyboard.	English, Japanese, United Kingdom, French, French (Canadian), German, Portuguese, Portuguese (Brazilian), Spanish, Spanish (Latin American), Italian	p. 15-20
Keyboard Repeat Delay	Keyboard repeat delay time setting.	100 ~ 1000 milliseconds (in 50 milliseconds steps)	
Keyboard Repeat Rate	Keyboard repeat rate setting.	2.0 ~ 30.0 cps	
Mouse Pointer Speed	Mouse pointer speed setting.	SLOW, MID, FAST	
Mouse Pointer Acceleration	Mouse Pointer Acceleration setting.	OFF, ON	
DHCP (Valid after Reboot)	DHCP server client setting.	OFF, ON	
USB DIAL Select	Selects the Sub band or Main and Sub band to operate on the RC-28's main dial.	SUB Only, MAIN/SUB	p. 15-20
USB DIAL Auto TS	Automatic tuning step function setting on the RC-28's main dial.	OFF, LOW, HIGH	
USB DIAL [TRANSMIT] Switch	Selects the key action for the [TRANSMIT] key on the RC-28.	Push to toggle, Hold down to transmit	
IP Address (Valid after Reboot)	Transceiver's IP address setting for IP remote control.		
Subnet Mask (Valid after Reboot)	Subnet mask setting for the IP remote control.		
Default Gateway (Valid after Reboot)	Default gateway setting for the IP remote control.		

■ OTHERS SET(Continued)

SET [F-7] ⊃ OTHERS [F-5]			
ITEMS	DESCRIPTIONS	RANGE OR VALUE	REF.
Primary DNS Server (Valid after Reboot)	Primary DNS (Domain Name System) server address setting for the IP remote control.		p. 15-20
2nd DNS Server (Valid after Reboot)	Secondary DNS (Domain Name System) server address setting for the IP remote control.		
Network Name	Network name setting for the optional RS-BA1 operation.	Up to 15 characters	p. 15-21
Network Control (Valid after Reboot)	Remote control setting for the optional RS-BA1 operation.	OFF, ON	
Control Port (UDP) (Valid after Reboot)	Control port number setting for the optional RS-BA1 operation.		
Serial Port (UDP) (Valid after Reboot)	Serial port number setting for the optional RS-BA1 operation.		
Audio Port (UDP) (Valid after Reboot)	Audio port number setting for the optional RS-BA1 operation.		
Internet Access Line (Valid after Reboot)	Internet access line setting for the IP remote control.	FTTH, ADSL/CATV	
Network User1/2/3 ID	User ID setting for the IP remote control operation.	Up to 16 characters	
Network User1/2/3 Password	Password setting for the IP remote control operation.	At least 8 characters, up to 16 characters	p. 15-22
Network User1/2/3 Administrator	Administrative privileges setting for the IP remote control operation.	NO, YES	
Network Radio Name	Radio name setting for the optional RS-BA1 operation.	Up to 16 characters	

## LOAD SET

SET [F-7] ▾ SD/USB [F-7] ▾ LOAD [F-1]

ITEMS	DESCRIPTIONS	RANGE OR VALUE	REF.
Load Contents	Loading contents setting.	All, Select	p. 10-4
ANT Memory	Antenna memory load setting.	YES, NO	
REF IN/OUT, REF Adjust, Filter CAL	Reference frequency signal, Reference frequency adjustment value, and 1.2 kHz filter calibration value load setting.	YES, NO	
CI-V Address	CI-V address load setting.	YES, NO	
Other Memory & Settings	Other memory and set items status load setting.	YES	
Voice TX Memory	TX voice memory load setting.	YES, NO	
Voice RX Memory	RX voice memory load setting.	YES, NO	

## SAVE SET

SET [F-7] ▾ SD/USB [F-7] ▾ SAVE [F-2]

ITEMS	DESCRIPTIONS	RANGE OR VALUE	REF.
SAVE Contents	Saving contents setting.	All, Select	p. 10-4
Memory & Settings	Memory and set items status save setting.	YES	
Voice TX Memory	TX voice memory save setting.	YES, NO	
Voice RX Memory	RX voice memory save setting.	YES, NO	
SAVE Form	Selects the file saving format.	Now Ver, Old Ver (xxx – xxx)	

## ANT TYPE

Multi function key [ANT](▶) ▾ ANT TYPE [F-7]

ITEMS	DESCRIPTIONS	RANGE OR VALUE	REF.
ANT2 Type	[ANT2]	Antenna usage setting. OFF, TX/RX	p. 13-4
ANT3 Type	[ANT3]		
ANT4 Type	[ANT4]		

## ■ VOX

[VOX/BK-IN]

ITEMS	DESCRIPTIONS	RANGE OR VALUE	REF.
VOX Delay	VOX delay time setting.	0.0 ~ 2.0 sec. (in 0.1 sec. steps)	p. 8-3
VOX Voice Delay	VOX voice delay setting for VOX operation.	OFF, Short, Mid, Long	

## ■ NB

[NB]

ITEMS	DESCRIPTIONS	RANGE OR VALUE	REF.
NB Depth	Noise blanker depth level setting	1~10 (in 1 digit steps)	p. 7-11
NB Width	Noise blanker pulse width setting.	1~100 (in 1 digit steps)	

## ■ FILTER SHAPE SET

[FILTER] ▸ SHAPE [F-7]

ITEMS	DESCRIPTIONS		RANGE OR VALUE	REF.	
HF SSB (600Hz – )	HF bands	SSB mode	SHARP, SOFT	p. 7-9	
HF SSB-D (600Hz – )		SSB-D mode			
HF CW ( – 500Hz)		CW mode			Filter shape setting when 500 Hz or narrower width is set.
HF CW (600Hz – )					Filter shape setting when 600 Hz or wider width is set.
50M SSB (600Hz – )	50 MHz band	SSB mode	SHARP, SOFT		
50M SSB-D (600Hz – )		SSB-D mode			
50M CW ( – 500Hz)		CW mode			Filter shape setting when 500 Hz or narrower width is set.
50M CW (600Hz – )					Filter shape setting when 600 Hz or wider width is set.

■ Unpacking .....	3-2
■ Selecting a location .....	3-2
■ Grounding .....	3-2
■ Attaching the rack mounting handle .....	3-2
■ Connecting antenna .....	3-3
■ Required connections .....	3-4
◇ Front panel (Electronic keyer and microphone) .....	3-4
◇ Rear panel (Basic connection) .....	3-4
■ Advanced connections .....	3-5
◇ Front panel (Microphone, headphones and SD card) .....	3-5
◇ Rear panel (Optional products and external equipment) .....	3-5
◇ Rear panel (Optional products and external equipment) .....	3-6
◇ Rear panel (External keypad and meter) .....	3-6
■ Linear amplifier connections .....	3-7
◇ Connecting the IC-PW1/EURO .....	3-7
◇ Connecting a non-Icom linear amplifier .....	3-7
■ FSK and AFSK (SSTV) connections .....	3-8
■ Microphones (optional products) .....	3-9
◇ SM-50 .....	3-9
◇ SM-30 .....	3-9
◇ HM-36 .....	3-10
■ Connecting the RC-28 (optional product) .....	3-10

 **CAUTION:** The transceiver weights approximately 23.5 kg (52 lb). Always have two people available to carry, lift or turn over the transceiver.

## ■ Unpacking

After unpacking, immediately report any damage to the delivering carrier or dealer. Keep the shipping cartons.

For a description and a diagram of accessory equipment included with the transceiver, see 'Supplied accessories' on page vii of this manual.

## ■ Selecting a location

Select a location for the transceiver that allows adequate air circulation, free from extreme heat, cold, or vibrations, and away from TV sets, TV antenna elements, radios and other electromagnetic sources.

The base of the transceiver has optional angled front feet for desktop use. If desired, place the optional feet over the standard feet. Be sure the angle of the bottom of the feet are such that the front of the transceiver is angled up, and is stable.

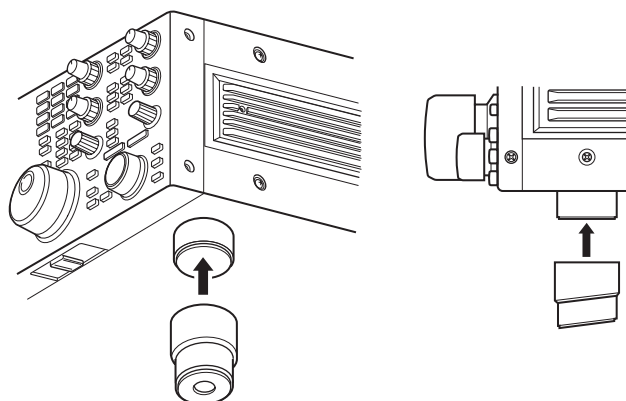

## ■ Grounding

To prevent electrical shock, television interference (TVI), broadcast interference (BCI) and other problems, ground the transceiver through the GROUND terminal on the rear panel.

For best results, connect a heavy gauge wire or strap to a long earth-sunk copper rod. Make the distance between the [GND] terminal and ground as short as possible.

**⚠ WARNING! NEVER** connect the [GND] terminal to a gas or electric pipe, since the connection could cause an explosion or electric shock.

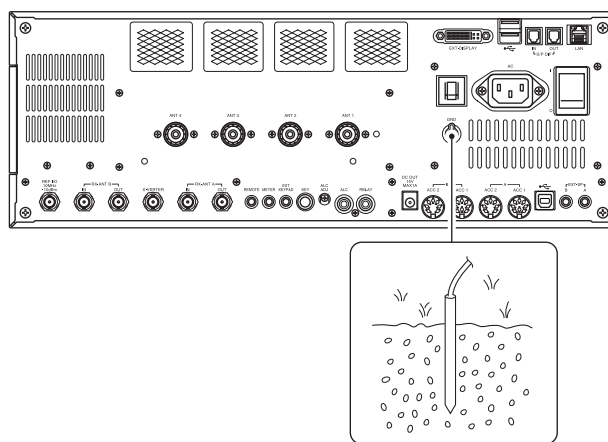

## ■ Attaching the rack mounting handle

Remove the two screws from each side of the front panel and the one screw from each side of the side panel. Attach the rack mounting handles to the sides of the transceiver using only the supplied accessory screws.

**⚠ CAUTION: NEVER** put the transceiver's rear panel side down after lifting up the transceiver by holding rack mounting handle. This may scratch the surface of the place or damage the connectors on the transceiver's rear panel.

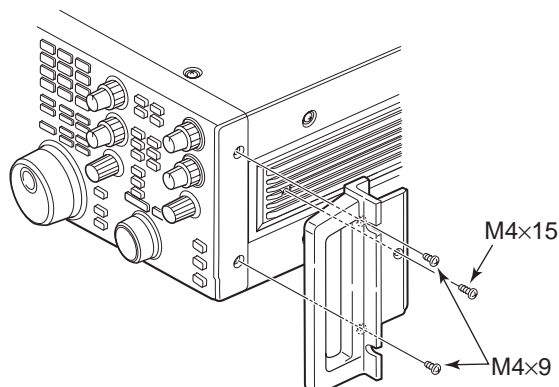



## ■ Connecting antenna

For radio communications, the antenna is of critical importance, along with the output power and receiver sensitivity. Select antennas, such as a well-matched 50 Ω antenna, and feedline.

If you use only one antenna, connect it to the [ANT1] connector.

**CAUTION:** Protect your transceiver from lightning by using a lightning arrestor.

## ■ Main dial attachment

The Main dial is shipped unattached to the transceiver to prevent possible damage to the dial shaft or rotary encoder during shipping. Please attach the dial as described below.

- ① Slide the dial brake adjustment to the right position.
  - The dial brakes move inward as shown.
- ② Insert the Main dial set-screw into the screw hole of the Main dial, then tighten the screw until the screw extends into the shaft hole out slightly using supplied hexagonal wrench (2 mm).
  - Be careful that the screw does not extend out more than 1 mm (0.04 in).
- ③ Attach the Main dial as illustrated.
- ④ Tighten the screw using supplied hexagonal wrench as illustrated.
- ⑤ Install the rubber cover to the Main dial little by little.
  - Be careful to match the correct position of the convex part of the rubber cover and the concave part of the dial knob.
  - Never install the rubber cover on the Main dial by force. This may cause damage to the dial shaft or rotary encoder.

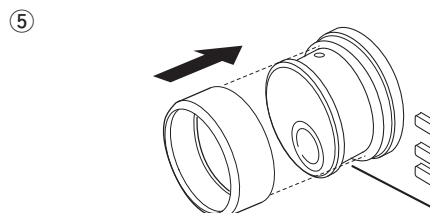
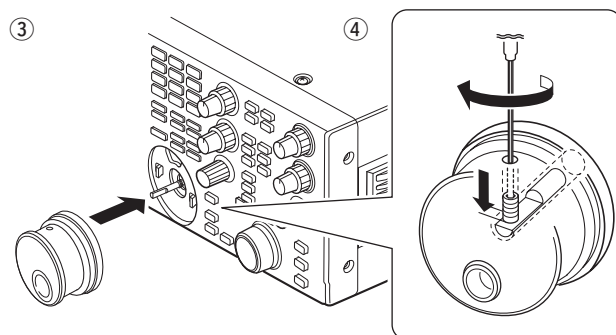
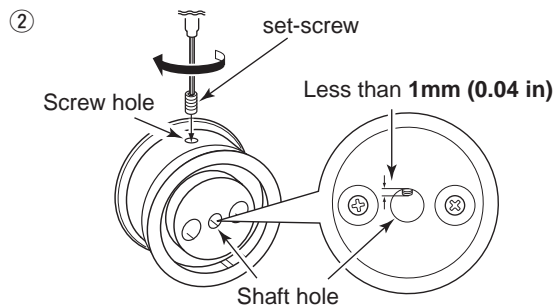
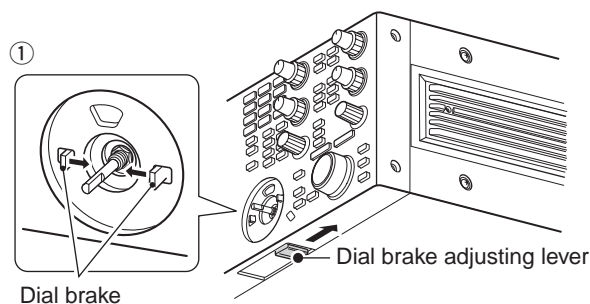

## Required connections

### Front panel (Electronic keyer and microphone)

#### CW key

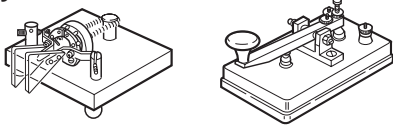

A straight or bug key can be used when the internal electronic keyer is turned OFF in keyer set mode. (p. 5-13)

#### Microphones (pp. 3-9, 3-10)



Optional SM-50

Optional SM-30

Optional HM-36

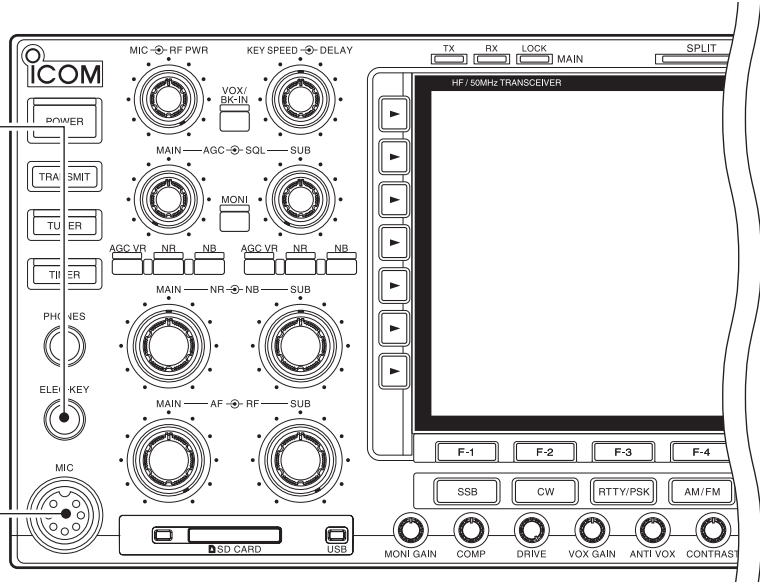

### Rear panel (Basic connection)

#### Antenna 1, 2, 3, 4 (p. 13-2)

[Example]: ANT1 for the 1.8–18 MHz bands, ANT 2 for the 21–28 bands, ANT3 for the 50 MHz band, and ANT 4 for a receive antenna.

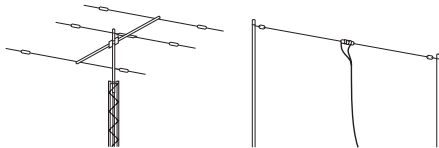

**NOTE:** Attach the supplied antenna connector cap when no antenna or external equipment is connected.

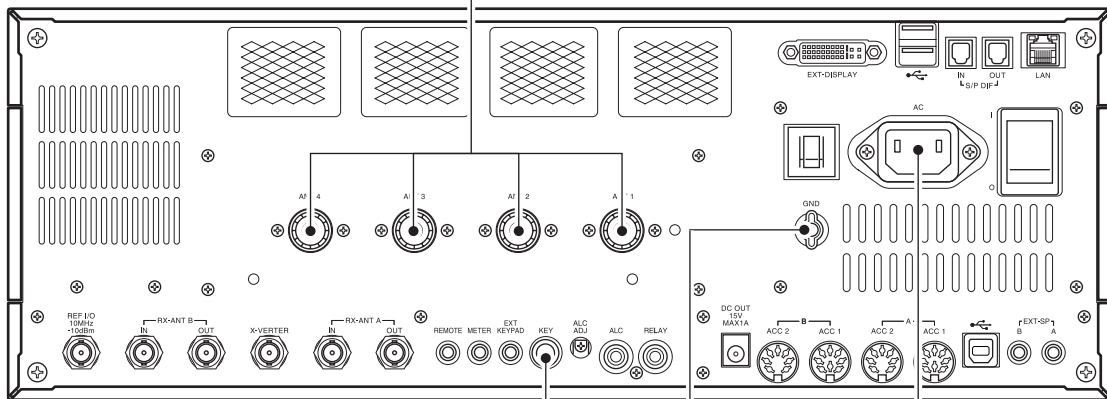

#### Straight key

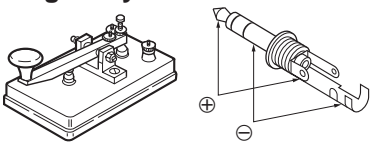

#### Ground (p. 3-2)

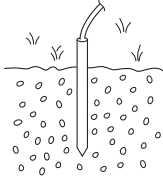

Use the heaviest gauge wire or strap available and make the connection as short as possible.

Grounding prevents electrical shock, TVI and other problems.

#### AC outlet

**WARNING!**  
Use only the supplied AC power cable.

### Advanced connections

#### Front panel (Microphone, headphones and SD card)

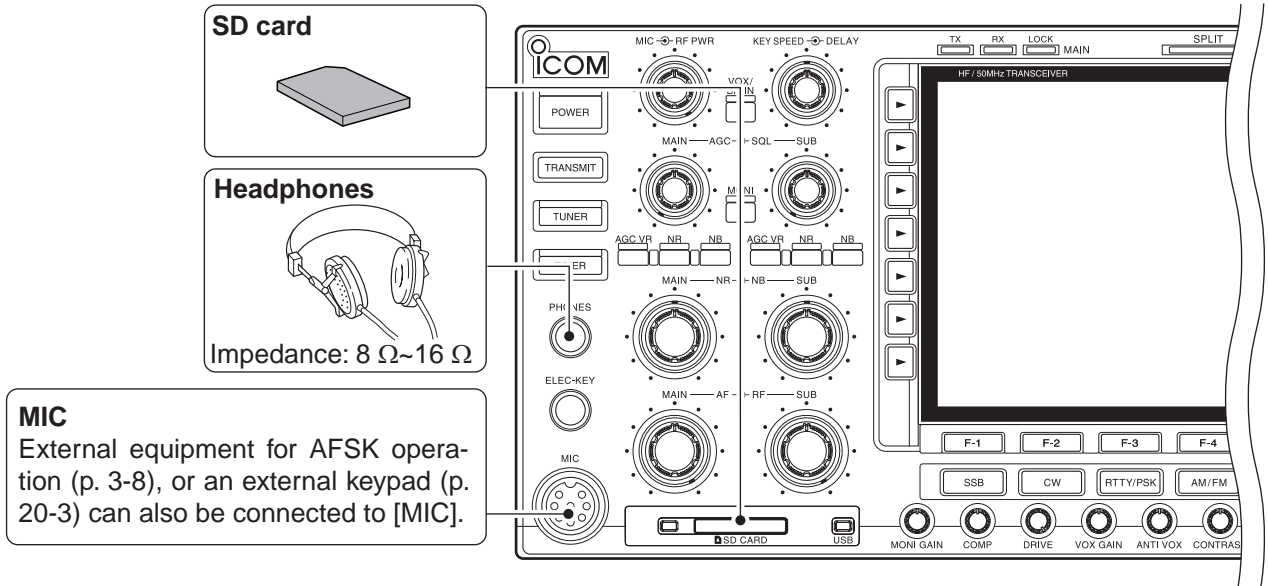

#### Rear panel (Optional products and external equipment)

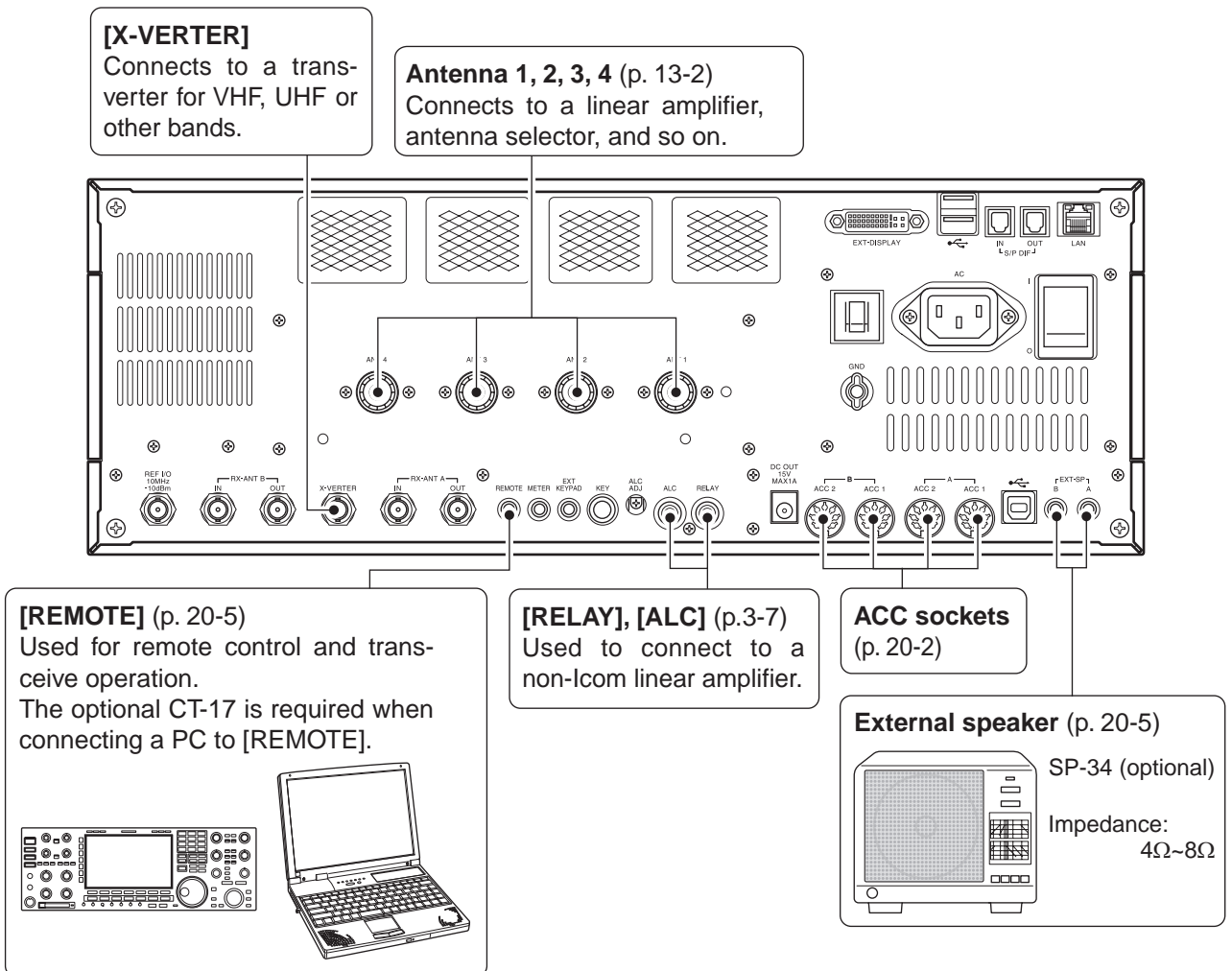

### 3 INSTALLATION AND CONNECTIONS

#### ■ Advanced connections (Continued)

#### ◇ Rear panel (Optional products and external equipment)

##### USB PORT



Connects to a USB device such as keyboard, mouse, hub, memory (USB flash drive), or optional RC-28.

- Turn OFF the transceiver's power before connecting or disconnecting a USB device.
- Do not connect two devices of the same type. (example: Connecting two USB mice.)
- The following devices are not supported.  
Multimedia adaptor, USB HDD, Bluetooth® mouse, Bluetooth® keyboard, a USB flash drive of more than 32 GB.

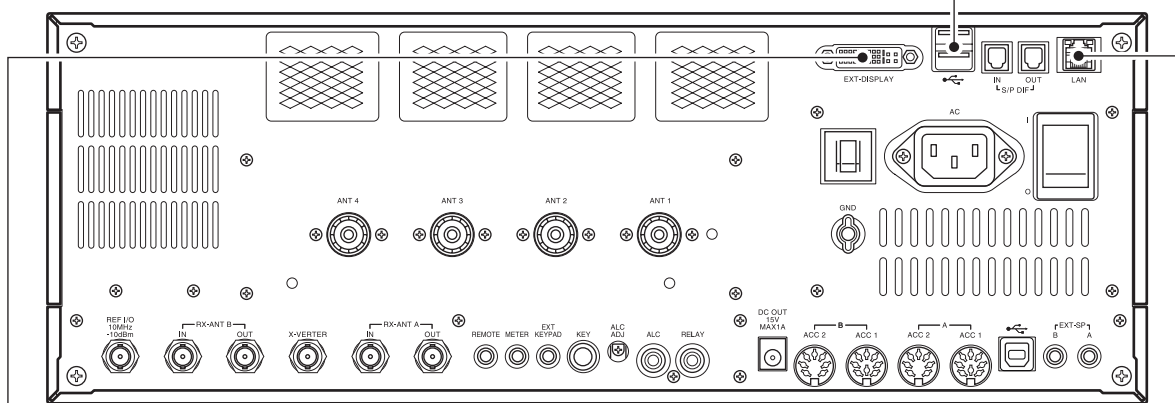

##### External Display



Connects to a PC-style monitor display. (DVI-I)

##### Ethernet connector (p. 18-2)

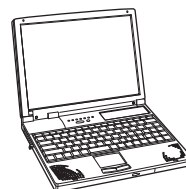

Connects to a PC for remote control through a LAN or the Internet using the RS-BA1, or for updating the CPU firmware.

#### ◇ Rear panel (External keypad and meter)

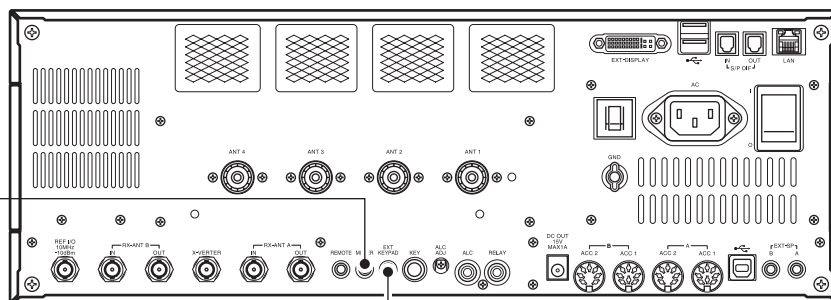
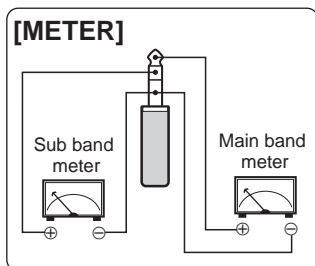

##### External keypad

Connects to an external keypad for voice memory, memory keyer, PSK memory and RTTY memory content transmission. (p. 20-4)

##### ✓ For your information:

An external keypad can also be connected to the microphone connector on the front panel. See page 20-3 for details.

## Linear amplifier connections

### Connecting the IC-PW1/EURO

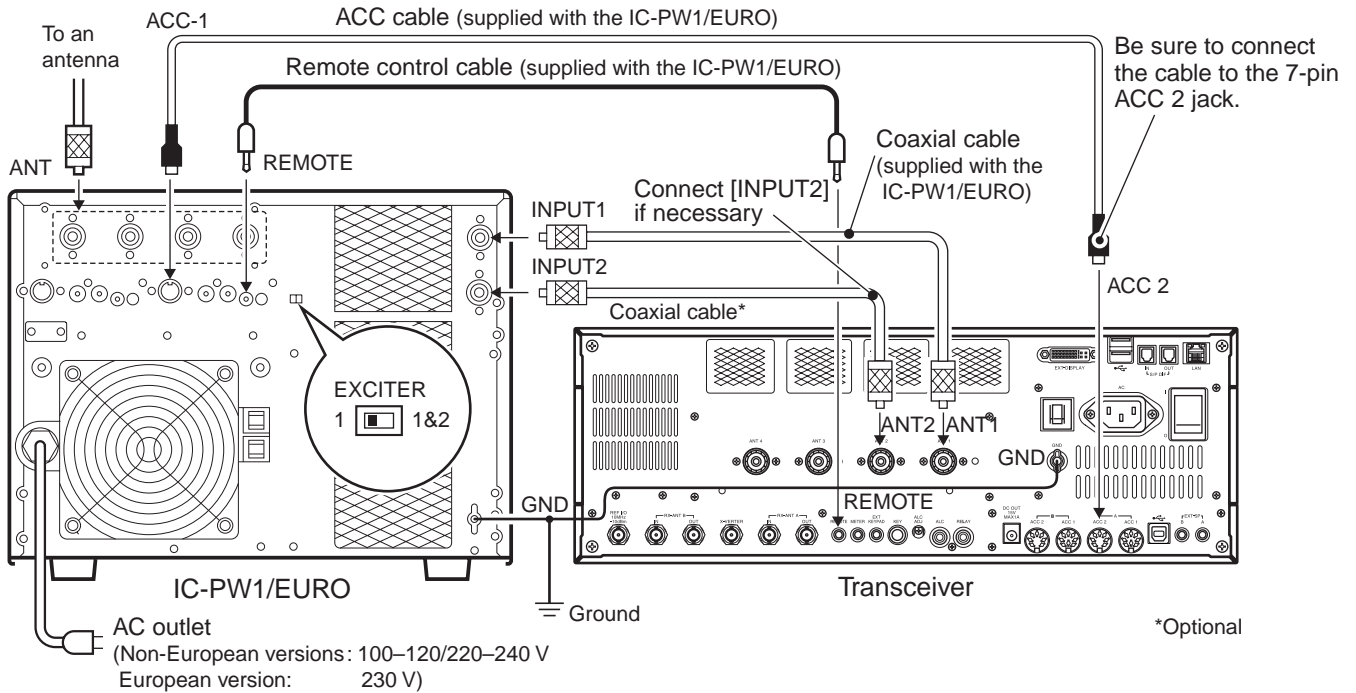

### Connecting a non-Icom linear amplifier

#### ⚠ WARNING!

Set the transceiver output power and linear amplifier ALC output level referring to the linear amplifier instruction manual.

The ALC input level must be in the range 0 V to -4 V. The transceiver does not accept positive voltage. Non-matched ALC and RF power settings could cause a fire or damage the linear amplifier.

The maximum control level of [RELAY] jack is 16 V/0.5 A DC with the initial setting, and 250 V/200 mA with the “MOS-FET” setting (see p. 20-4 for details). Use an external relay unit when your non-Icom linear amplifier requires a control voltage and/or current greater than specified.

When using a linear amplifier that has a time delay between receiving and transmitting, a high SWR might cause the linear amplifier to malfunction. To prevent this, slow the TX Delay the “TX Delay (HF), (50M)” settings in the Others Set mode. (p. 15-13)

SET (F-7) > OTHERS (F-5) > TX Delay (HF), (50M)

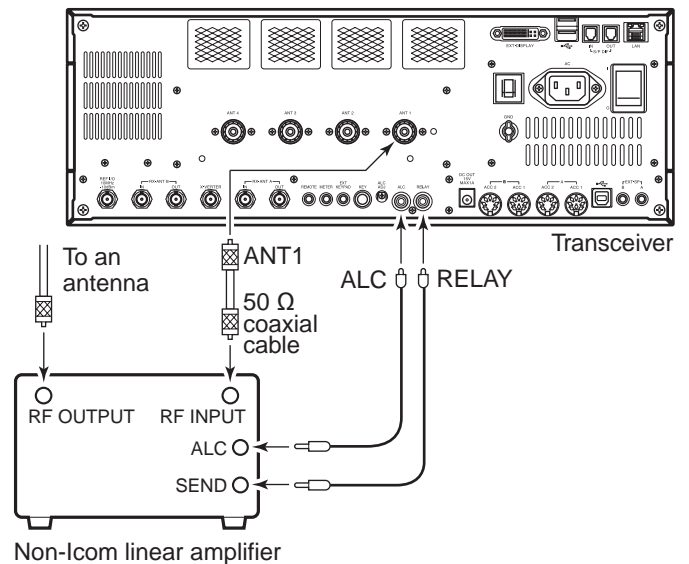

## FSK and AFSK (SSTV) connections

The transceiver has a Modem function for RTTY and PSK. However, if you want to use a PC to operate these digital modes, it is necessary to prepare the following interface circuit, or use a similar 3rd party device.

Refer to the instruction manual for the device prior to connecting it.

### (1) When using the USB port

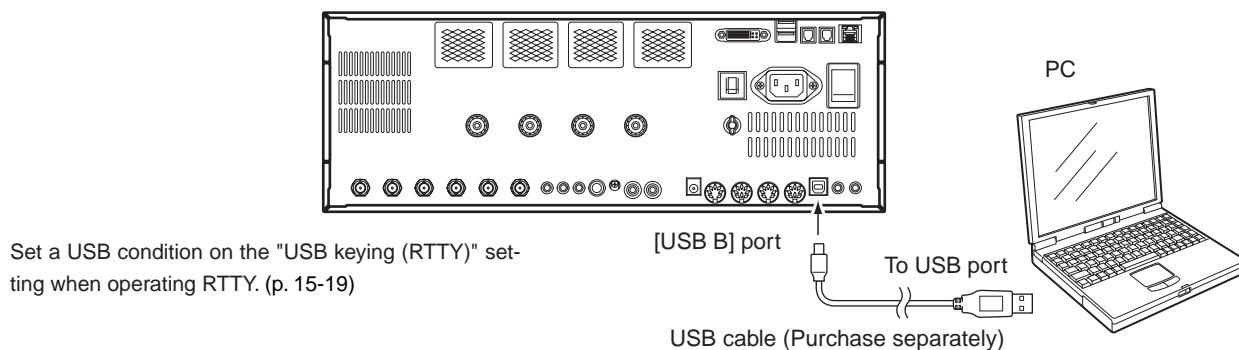

### (2) When using the ACC socket or the microphone connector

Example interface circuit for digital modes (Not provided by Icom)

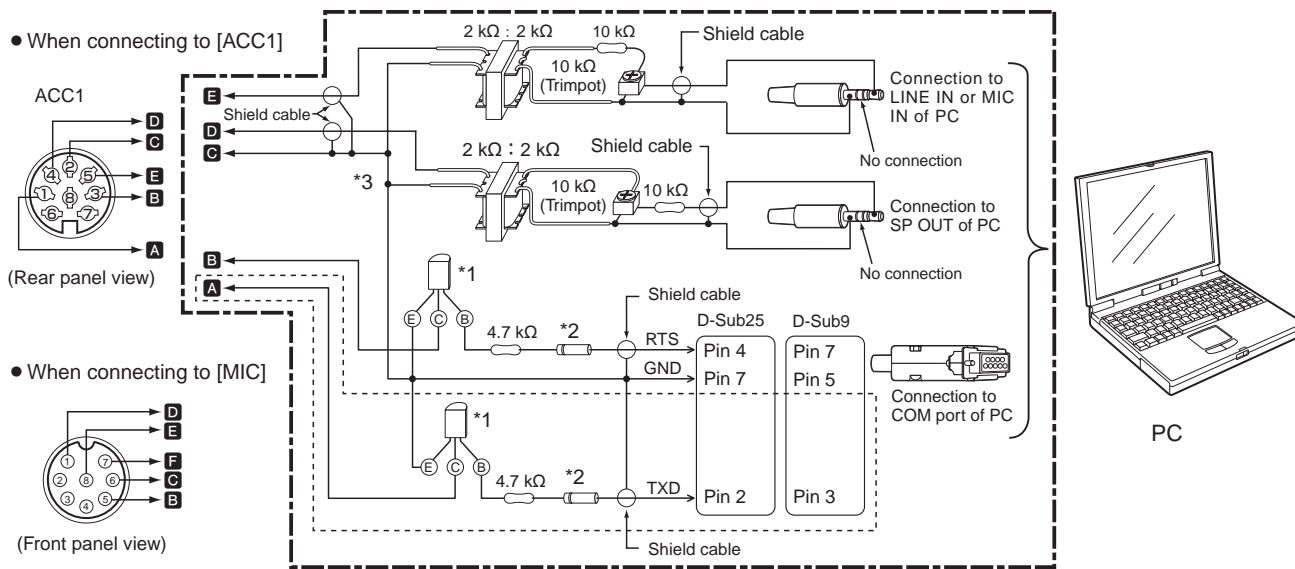

**NOTE:**  
You cannot operate RTTY (FSK) operation when you connect the circuit to the microphone connector.

- \*1 NPN transistor (2SC1815)
- \*2 switching diode (1S1588)
- \*3 Connect to [C] when using ACC1. Connect to [F] when using the microphone connector.

□ The sections shown in squares are required only when Baudot RTTY is used in FSK (RTTY) mode. (Other digital mode operations such as SSTV or PSK are not required.)



## ■ Microphones (optional products)

### ◇ SM-50

TOP VIEW

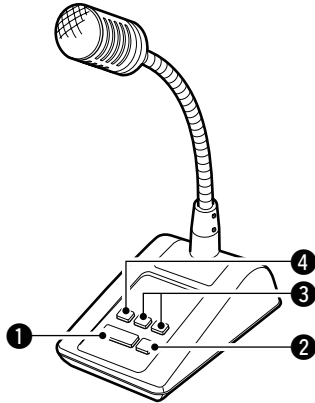

BOTTOM VIEW

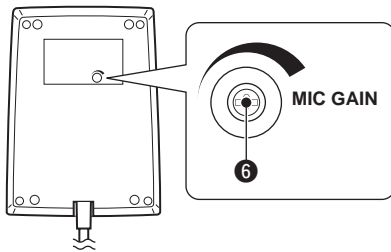

#### ① PTT SWITCH

Hold down to transmit, release to receive.

#### ② PTT LOCK SWITCH

Push to lock the PTT switch in the transmit mode.

#### ③ UP/DOWN SWITCHES [UP]/[DN]

Change the selected readout frequency or memory channel.

- Holding down continuously changes the frequency or memory channel.
- While holding down [XFC], the transmit readout frequency can be controlled while in the split frequency mode.
- The [UP]/[DN] switch can simulate a key paddle. Preset in the keyer set mode. (p. 5-13)

#### ④ LOW CUT SWITCH

Push (SM-50)/Slide (SM-30) to cut out the low frequency components of input voice signals.

#### ⑤ PTT LOCK INDICATOR [LOCK]

(Only for the SM-30)

Lights red when the PTT lock switch (②) is ON.

#### ⑥ MIC GAIN VOLUME [MIC GAIN]

Rotate to adjust the microphone output level.

- Use this control as an addition to the microphone gain setting of the transceiver.

Rotating the control too far clockwise may result in an output level that is too high and transmit signal distortion.

### ◇ SM-30

TOP VIEW

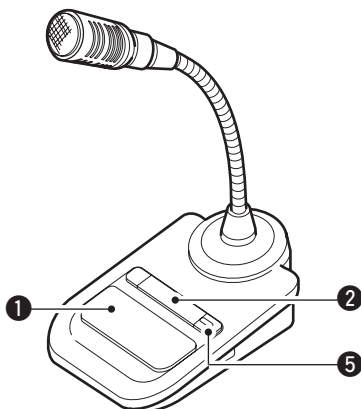

BOTTOM VIEW

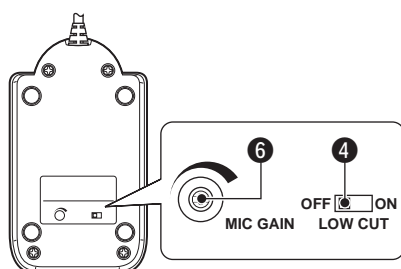



### 3 INSTALLATION AND CONNECTIONS

#### ■ Microphones (optional products) (Continued)

##### ◇ HM-36

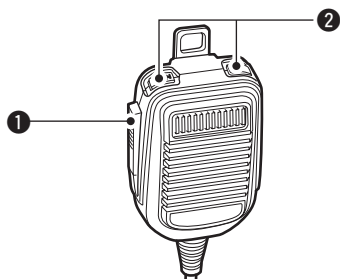

#### ① PTT SWITCH

Hold down to transmit, release to receive.

#### ② UP/DOWN SWITCHES [UP]/[DN]

Change the selected readout frequency or memory channel.

- Holding down continuously changes the frequency or memory channel.
- While holding down [XFC], the transmit readout frequency can be controlled while in the split frequency mode.
- The [UP]/[DN] switch can simulate a key paddle. Preset in the keyer Set mode. (p. 5-13)

### ■ Connecting the RC-28 (optional product)

The optional RC-28 REMOTE ENCODER can be used as a remote control dial.

#### NOTE:

- See the RC-28's manual to use the RC-28 with the RS-BA1 IP REMOTE CONTROL SOFTWARE.
- Using the RC-28 with other than the USB cable supplied with the RC-28, or connecting it through a USB hub, is not guaranteed by Icom.

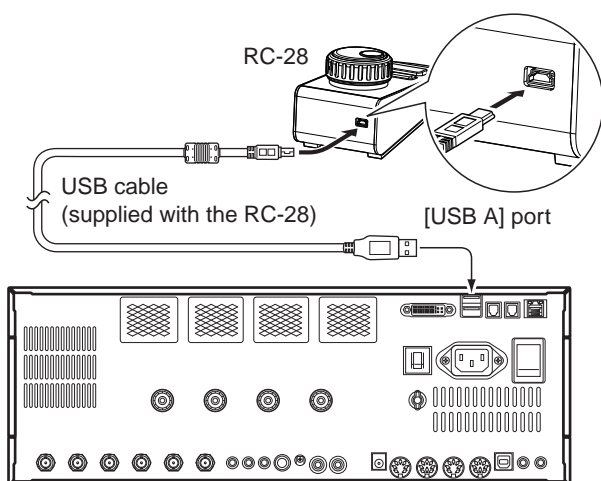

#### ◇ Using the RC-28

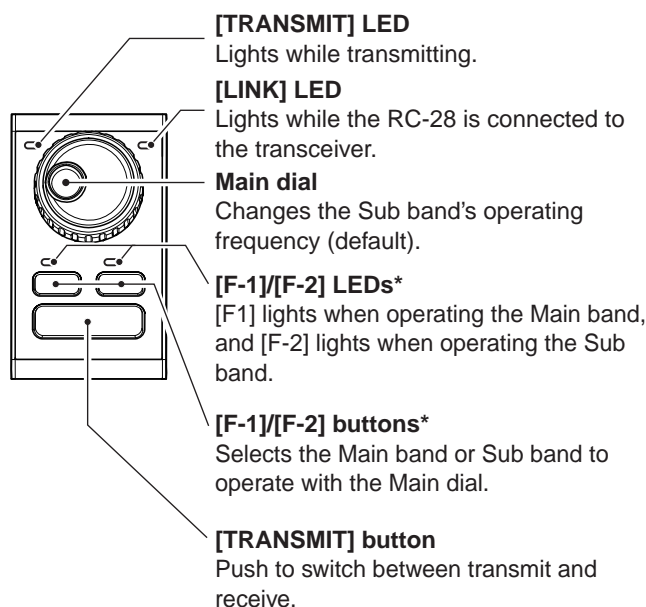

\* The [F-1] and [F-2] buttons are disabled when "USB Dial Select" is set to "SUB Only."

- Setting the "USB DIAL Select" to "MAIN/SUB" enables you to operate both the Main band and the Sub band, using the RC-28.  
(SET [F-7] > OTHERS [F-5] > USB DIAL Select)

---

■ When first applying power .....	4-2
■ Power ON .....	4-3
◇ Resetting the CPU (initial setup) .....	4-3
■ Adjusting the Audio level .....	4-4
■ Adjusting the Squelch level .....	4-4
■ Adjusting the RF gain .....	4-4
■ Selecting the Main and Sub bands .....	4-5
■ Selecting the VFO or Memory mode .....	4-5
■ Selecting an operating band.....	4-6
◇ Using the band stacking registers .....	4-6
■ Setting the frequency .....	4-7
◇ Tuning with [DIAL] .....	4-7
◇ About the Quick tuning step .....	4-7
◇ Selecting the Fine tuning function .....	4-8
◇ About the Auto tuning step function .....	4-8
◇ About the 1/4 tuning step function .....	4-9
◇ Entering the frequency with the keypad.....	4-9
■ Selecting the Operating mode .....	4-10
■ Selecting the Meter readout .....	4-11
◇ Digital multi-function meter .....	4-11
◇ Selecting the meter type .....	4-12
■ Dial lock function .....	4-12
■ Basic transmit operation .....	4-13
◇ Transmitting .....	4-13
◇ Adjusting the microphone gain .....	4-13
◇ Adjusting the drive gain .....	4-14
◇ Transmit power limit .....	4-14
■ Band edge warning beep .....	4-15
◇ Entering the user band edge .....	4-16
■ About the 5 MHz frequency band operation (USA version only) ...	4-18

## ■ When first applying power

Before first applying power, confirm the following connections or settings:

- Antennas are properly connected. (p. 3-4)
- A ground wire is properly connected. (p. 3-2)
- External devices such as a liner amplifier, if used, are properly connected. (pp. 3-5~3-7).
- All controls are set as shown below.

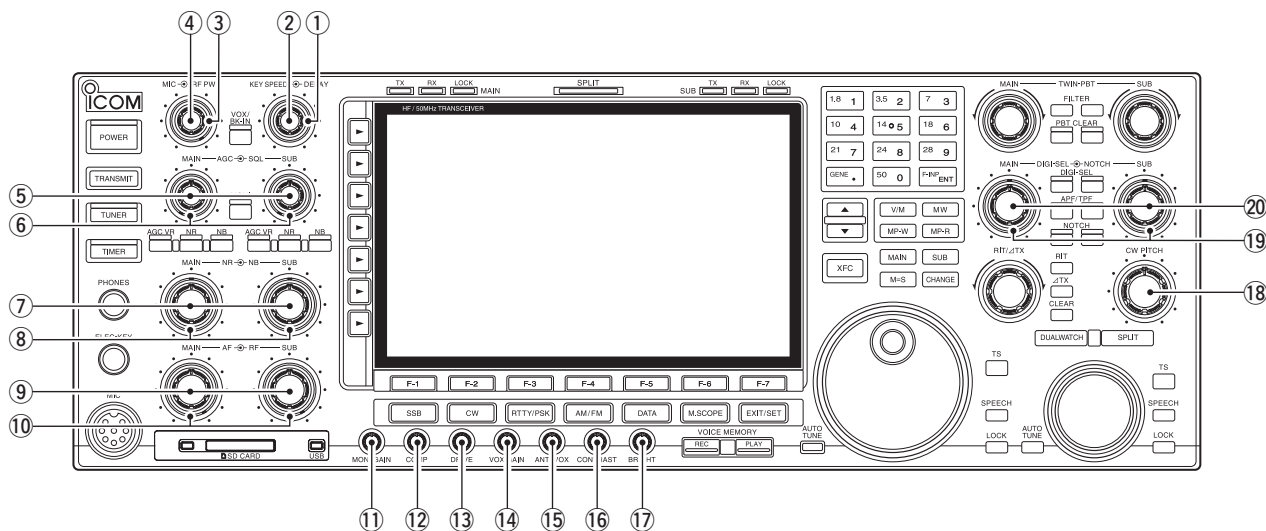

No.	Control	Position	No.	Control	Position
①	DELAY control	Fully counterclockwise	⑪	MONI GAIN control	12 o'clock
②	KEY SPEED control	Fully counterclockwise	⑫	COMP control	12 o'clock
③	RF PWR control	Fully clockwise	⑬	DRIVE control	12 o'clock
④	MIC control	12 o'clock	⑭	VOX GAIN control	12 o'clock
⑤	AGC control	12 o'clock	⑮	ANTI VOX control	12 o'clock
⑥	SQL control	Fully counterclockwise	⑯	CONTRAST control	12 o'clock
⑦	NR control	Fully counterclockwise	⑰	BRIGHT control	12 o'clock
⑧	NB control	Fully counterclockwise	⑱	CW PITCH control	12 o'clock
⑨	AF control	Fully counterclockwise	⑲	NOTCH control	12 o'clock
⑩	RF control	Fully clockwise	⑳	DIGI-SEL control	12 o'clock

All keys of this transceiver are non lock type.

When turned ON, the transceiver starts with all keys' status as they were previously set. However, the [TRANSMIT] key always in the OFF (receive) condition at power ON.

## ■ Power ON

- ① Push [I/O] on the rear panel to turn ON the main power.
  - The transceiver power is still OFF but the [POWER] indicator lights orange.
  - When first applying power, refer to the 'Resetting the CPU (initial setup).'
- ② Push [POWER] on the front panel.
  - The transceiver's power is ON, and the power indicator lights blue.
  - After 4 seconds, the transceiver displays the Opening screen, and then displays the initial screen.
  - To turn OFF the power, hold down [POWER] for 1 second.
  - If you don't operate the transceiver for a long period of time, turn OFF the main power.

### NOTE:

Before turning OFF the main power, make sure the transceiver's power is OFF and the [POWER] indicator lights orange.

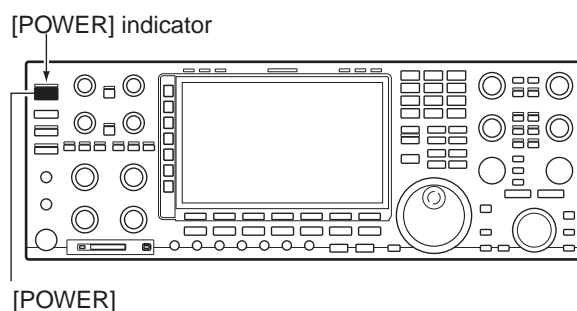
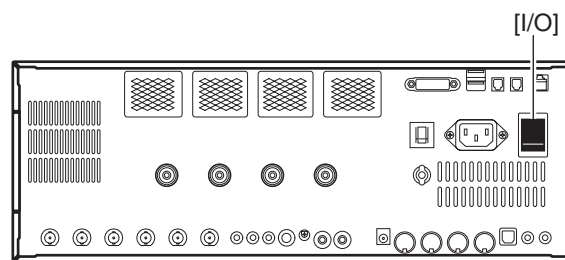

### • Opening screen



### • Opening screen (with opening message)



### ◇ Resetting the CPU (initial setup)

Before first applying power, if a malfunction occurs, or you want to return the transceiver to the original settings, reset the transceiver using the following procedure.

- ➔ While holding down [F-INP] and [MW], push [POWER] to turn ON the power.
  - The transceiver's power is ON, and the power indicator lights blue.
  - After "ALL CLEAR" is displayed, the transceiver displays the initial screen.

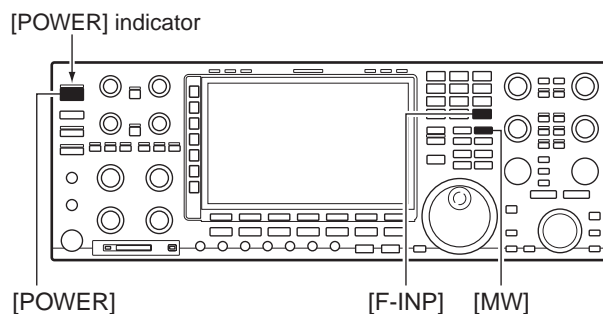

## ■ Adjusting the Audio level

- Rotate the [AF] control to adjust the audio output level.
  - Set a suitable audio level.

Independently adjust the Main and Sub bands.

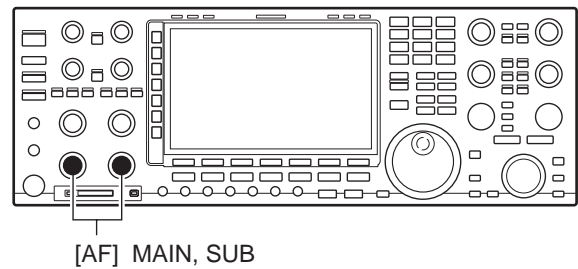

## ■ Adjusting the Squelch level

### Noise squelch:

In the FM mode, rotate the [SQL] control and adjust to the point where the noise just disappears and the RX indicator goes OFF.

The noise squelch works only in the FM mode.

### S-meter squelch:

The S-meter squelch disables the audio output from the speaker or headphones when the received signal is weaker than the specified level.

Rotate the [SQL] control clockwise from the 12 o'clock position to adjust the S-meter level (threshold level).

The S-meter squelch works in all modes.

Independently adjust the Main and Sub bands.

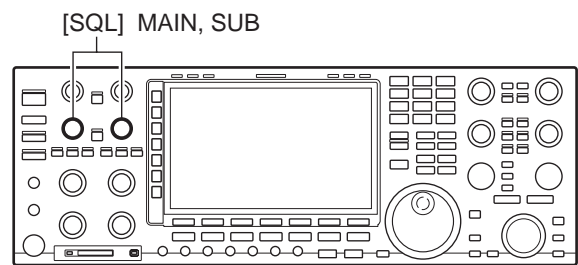

### • In the FM mode

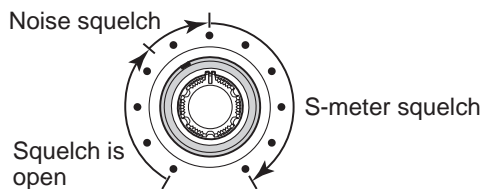

### • In other than the FM mode (SSB/CW/RTTY/PSK/AM)

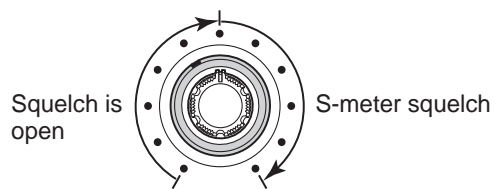

## ■ Adjusting the RF gain

The [RF] control adjusts the receiver sensitivity. This is usually set for maximum sensitivity (maximum clockwise).

When you rotate the [RF] control counterclockwise, the receive sensitivity decreases. At this time, the S-meter indicates the relative sensitivity level.

If you do not want to receive signals or noises from a nearby strong station, rotate the [RF] control to the point the just a little lower than the S-meter level.

Independently adjust the Main and Sub bands.

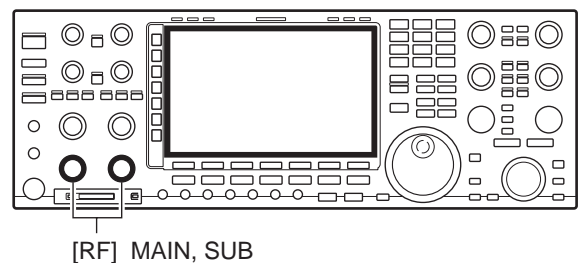

## ■ Selecting the Main and Sub bands

This transceiver has 2 identical receivers, Main and Sub. The Main band is displayed on the left hand side, and the Sub band is displayed on the right hand side of the LCD. Some functions can only be applied to the selected band, and transmission occurs on only the Main band (except during split frequency operation).

- ➔ Push [MAIN] to select the Main band.
  - The key backlight for [MAIN] lights.
  - The Main band's frequency readout is highlighted.
- ➔ Push [SUB] to select the Sub band.
  - The key backlight for [SUB] lights.
  - The Sub band's frequency readout is highlighted.

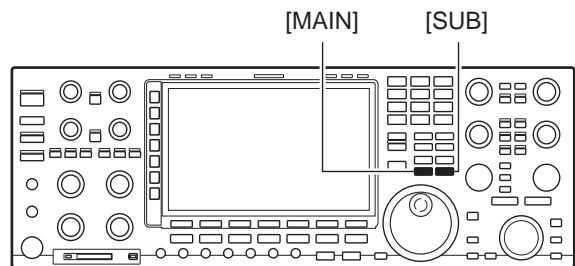

## ■ Selecting the VFO or Memory mode

- ➔ Push [V/M] to toggle between the VFO and Memory modes.
  - "VFO" appears when in the VFO mode, and the selected memory channel number appears when in the Memory mode.
  - Hold down [V/M] for 1 second to transfer the contents of the selected memory channel to the VFO. (p. 11-5)

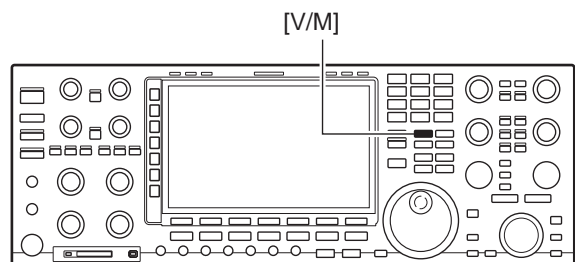

## ■ Selecting an operating band

The triple band stacking register provides three memories for each band to store frequencies and operating modes.

If a band key is pushed once, the last used frequency and operating mode are called up. When the key is pushed again, the next previous stored frequency and operating mode are called up.

- Push the band key that corresponds to the desired operating bands [1.8]~[50] to select the amateur band.
- The frequency and operating mode are memorized into the band register of the selected frequency.

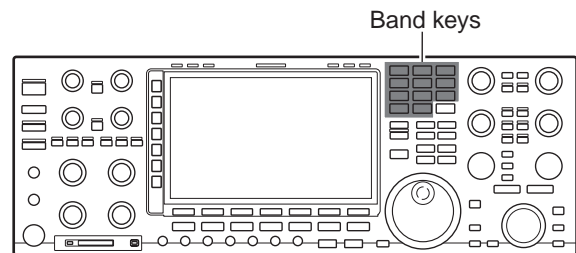

See the table below for a list of the selectable frequency bands and their default frequency and mode settings.

BAND	REGISTER 1	REGISTER 2	REGISTER 3
1.8 MHz	1.900000 MHz CW	1.910000 MHz CW	1.915000 MHz CW
3.5 MHz	3.550000 MHz LSB	3.560000 MHz LSB	3.580000 MHz LSB
7 MHz	7.050000 MHz LSB	7.060000 MHz LSB	7.020000 MHz CW
10 MHz	10.120000 MHz CW	10.130000 MHz CW	10.140000 MHz CW
14 MHz	14.100000 MHz USB	14.200000 MHz USB	14.050000 MHz CW
18 MHz	18.100000 MHz USB	18.130000 MHz USB	18.150000 MHz USB
21 MHz	21.200000 MHz USB	21.300000 MHz USB	21.050000 MHz CW
24 MHz	24.950000 MHz USB	24.980000 MHz USB	24.900000 MHz CW
28 MHz	28.500000 MHz USB	29.500000 MHz USB	28.100000 MHz CW
50 MHz	50.100000 MHz USB	50.200000 MHz USB	51.000000 MHz FM
General*	15.000000 MHz USB	15.100000 MHz USB	15.200000 MHz USB

\* The “General” band stores the frequencies that are out of the frequency ranges of the other bands, [1.8]~[50].

### ◇ Using the band stacking registers

[Example: Operating in the 21 MHz band]

- ① Push the [21] key, and then select a frequency and/or operating mode.
  - The selected frequency and operating mode are memorized in the first band stacking register for that band.
- ② Push [21] again, and then select another frequency and/or operating mode.
  - The selected frequency and operating mode are memorized in the second band stacking register.
- ③ Push [21] again, and then select another frequency and/or operating mode.
  - The selected frequency and operating mode are memorized in the third band stacking register.
- ④ Push other band keys, and then push [21] again.
  - The last used frequency and operating mode in the 21 MHz band are displayed.
  - Each push of [21] selects the next band stacking register.

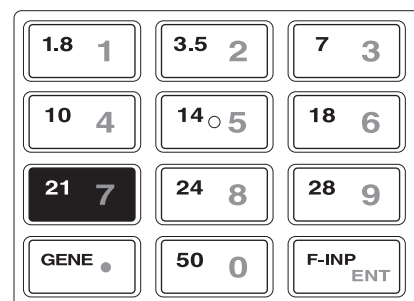



## ■ Setting the frequency

The transceiver has several setting methods for convenient frequency setting.

### ◇ Tuning with [DIAL]

- ① Select the desired band with the band keys.
- ② Rotate [MAIN DIAL] to set the desired frequency in the Main band.  
Rotate [SUB DIAL] to set the desired frequency in the Sub band.

#### ✓ CONVENIENT!

The [SUB DIAL] is always ready to tune the Sub band. The Sub dial allows you to quickly tune the Sub band without changing from Main to Sub.

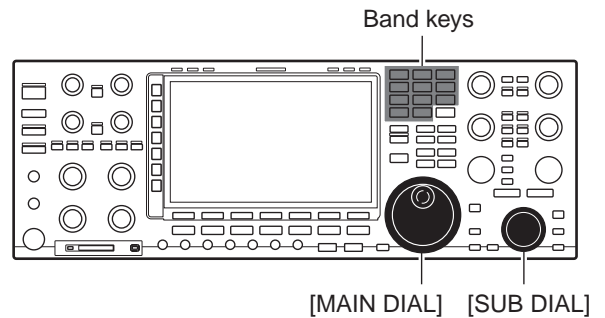

### ◇ About the Quick tuning step

The operating frequency can be changed in kHz steps for quick tuning. The Quick tuning function can be independently set for the Main and Sub bands.

#### • Tuning

- ① Push [TS].
  - “▼” is displayed and the Quick tuning function is turned ON.
- ② Rotate [MAIN DIAL].
  - The frequency changes in kHz steps.
- ③ Push [TS] again.
  - “▼” disappears and the Quick tuning function is turned OFF.

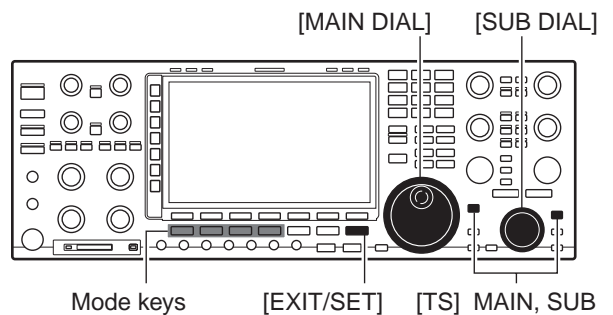

#### • Selecting the desired “kHz” step

- ① Push [TS].
  - “▼” is displayed and the Quick tuning function is turned ON.
- ② Hold down [TS] for 1 second.
  - The TS screen is displayed.
- ③ Push the desired Mode key.
  - The operating mode is selected.
- ④ Rotate [MAIN DIAL] to select a tuning step.
  - Selectable tuning steps: 0.1, 1, 5, 9, 10, 12.5, 20, or 25 kHz
  - Push [DEF](F) for 1 second to return the tuning step to the default setting.
- ⑤ Repeat steps ③ and ④ to select Quick tuning steps for other modes, if desired.
- ⑥ Push [EXIT/SET] to exit the setting display.

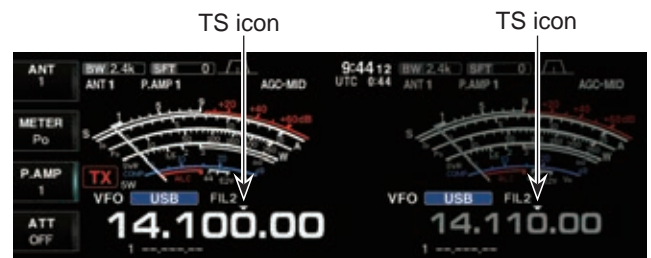

#### • TS screen

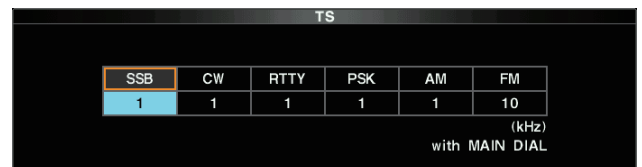

The TS screen can be entered from the Main or Sub band.

The selected tuning step is used for both the Main and Sub bands.

## 4 BASIC OPERATION

### ■ Setting the frequency (Continued)

#### ◇ Selecting the Fine tuning function

The minimum tuning step of 1 Hz can be used for fine tuning.

○ With the Quick tuning function OFF.

- ① Hold down [TS] for 1 second.
  - The 1 Hz digit is displayed.
- ② Rotate [MAIN DIAL] to tune the frequency.
  - The frequency changes in 1 Hz steps.
  - The RIT or ΔTX frequency also changes in 1Hz steps.
  - Pushing the [UP] or [DN] key on the microphone changes the frequency in 50 Hz steps, even if this Fine tuning function is ON.
  - To turn OFF the Fine tuning function, hold down [TS] for 1 second with the Quick tuning function OFF.



/// **NOTE:** 1 Hz tuning step functions for both Main and Sub bands simultaneously. Therefore, either [TS] can be used to select the 1 Hz tuning steps.

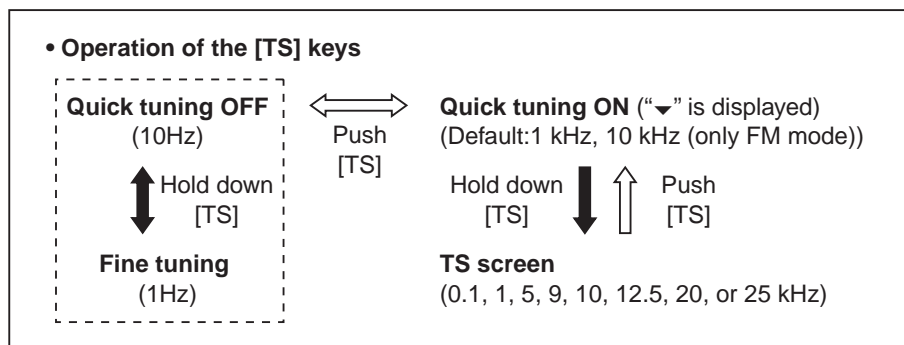

#### ◇ About the Auto tuning step function

When rapidly rotating [MAIN DIAL] or [SUB DIAL], the tuning speed automatically accelerates as selected.

- ① Select the “MAIN DIAL Auto TS” item in the Others set screen.

**SET [F-7] ▾ OTHERS [F-5] ▾ MAIN DIAL Auto TS**

- “MAIN DIAL Auto TS” for [MAIN DIAL], “SUB DIAL Auto TS” for [SUB DIAL] selection.
- ② Rotate [MAIN DIAL] to select the option.
    - Auto tuning step options
      - HIGH: Approximately 5 times faster when the tuning step is set to 1 kHz or smaller steps. Approximately 2 times faster when the tuning step is set to 5 kHz or larger steps.
      - LOW: Approximately 2 times faster.
      - OFF: Auto tuning step is turned OFF.
  - ③ Push [EXIT/SET] several times.
    - Exits the Set screen.

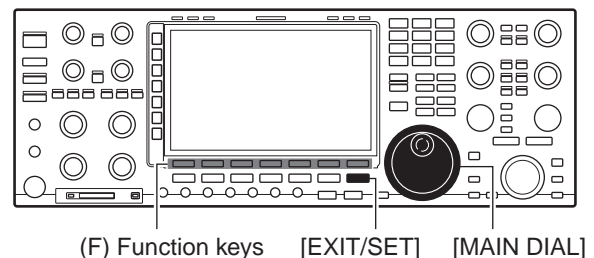

◇ About the 1/4 tuning step function

When operating in the SSB data, CW, RTTY or PSK modes, the 1/4 tuning function is selectable. When the function is ON, the dial speed is reduced to 1/4 of the normal speed, for finer tuning control.

- ➔ Push the Multi-function [1/4] key to toggle the 1/4 tuning function ON or OFF.
  - “1/4” is displayed when the function is ON.

1/4 tuning step OFF

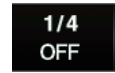

1/4 tuning step ON



◇ Entering the frequency with the keypad

The transceiver has a keypad for direct frequency entry, as described below.

- ① Push [F-INP].
  - The “F-INP” indicator is displayed.
  - The keypad backlight lights and the keys stand by for key entry.
- ② Enter the desired frequency from the highest digit.
  - The frequency disappears and the entered number is displayed on the right end digit.
- ③ Enter the next digit.
  - The previously entered number shifts one digit left.
- ④ After entering the MHz digit, push [.] (decimal point).
  - The previously entered numbers shift to the MHz digit.
- ⑤ After entering the 100 kHz and lower digits, push [ENT].
  - The “F-INP” indicator disappears and the frequency is set.
  - If the 100 kHz or lower digits are all ‘0,’ directly push [ENT] to automatically enter ‘0s.’
  - If you want to change only the 100 kHz or lower digits, skip steps ② and ③.
  - To cancel the entry, push any key (except [▲]/[▼]) before pushing [ENT].

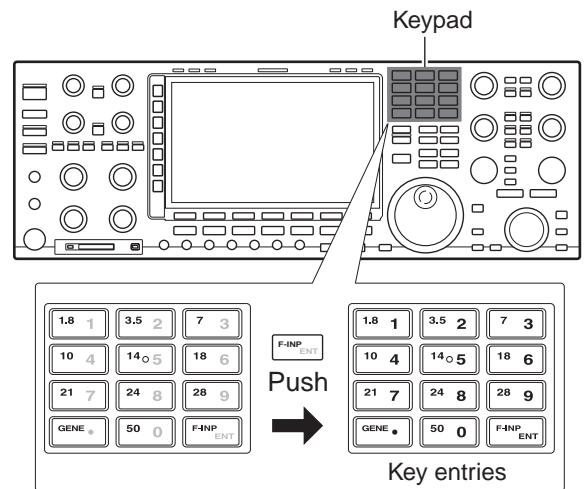

[EXAMPLE]

7.0000 MHz

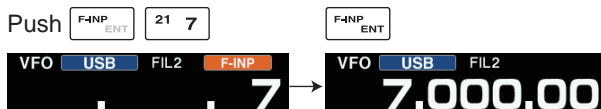

21.2400 MHz

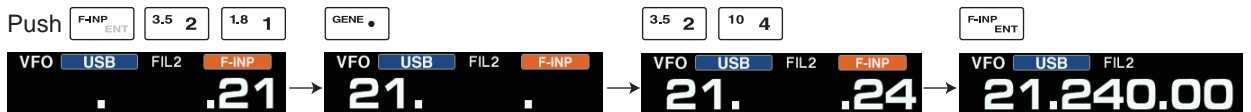

21.2400 MHz ⇨ 21.3600 MHz

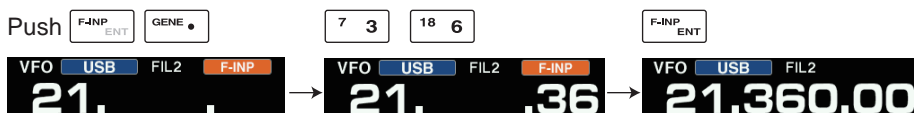

## ■ Selecting the Operating mode

The following modes are selectable.

- SSB (USB/LSB) and SSB data (USB data/LSB data) modes
- CW and CW reverse (CW-R) modes
- RTTY and RTTY reverse (RTTY-R) modes
- PSK and PSK reverse (PSK-R) modes
- AM and AM data modes
- FM and FM data modes

Select the desired operating mode as follows.

To select an operating mode

- 1 Push the desired Mode key.
- 2 Push the key again to toggle between USB and LSB, CW and CW-R, RTTY/RTTY-R and PSK/PSK-R, AM and FM, if desired.
- 3 Hold down the key for 1 second to toggle between RTTY and RTTY-R, PSK and PSK-R.

See the diagram to the right for the order of selection. When the data mode is selected, the microphone signals may be muted, depending on the Set mode setting.

### • Selecting the SSB mode

- Push [SSB] to select USB or LSB.
  - USB is selected first when operating above 10 MHz, LSB is selected first when operating below 10 MHz.
- USA version:**
  - USB is selected when the 5 MHz band is selected.
- After USB or LSB is selected, push to toggle between USB and LSB.

### • Selecting the CW mode

- Push [CW] to select CW.
  - After CW is selected, push to toggle between CW and CW reverse mode.

### • Selecting the RTTY or PSK mode

- Push [RTTY/PSK] to select RTTY or PSK.
  - After RTTY or PSK is selected, push to toggle between RTTY and PSK.
  - After RTTY or PSK is selected, hold down for 1 second to toggle between RTTY and RTTY reverse, or, PSK and PSK reverse mode, respectively.

### • Selecting the AM or FM mode

- Push [AM/FM] to select AM or FM.
  - After AM or FM is selected, push to toggle between AM and FM.

### • Selecting the DATA mode

- After USB, LSB, AM or FM is selected, push [DATA] to select the USB data, LSB data, AM data or FM data mode, respectively.
  - After a data mode is selected, push to toggle between regular voice and data mode.
  - After the data mode is selected, hold down for 1 second to sequentially select data 1, 2, and 3.

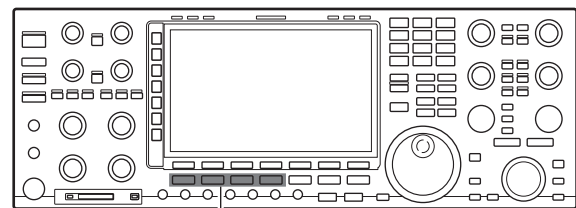

Mode keys

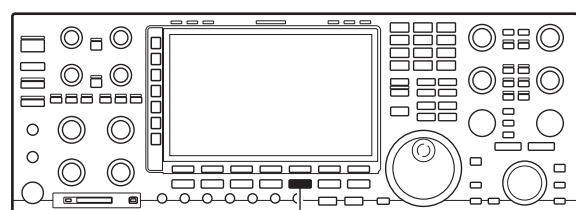
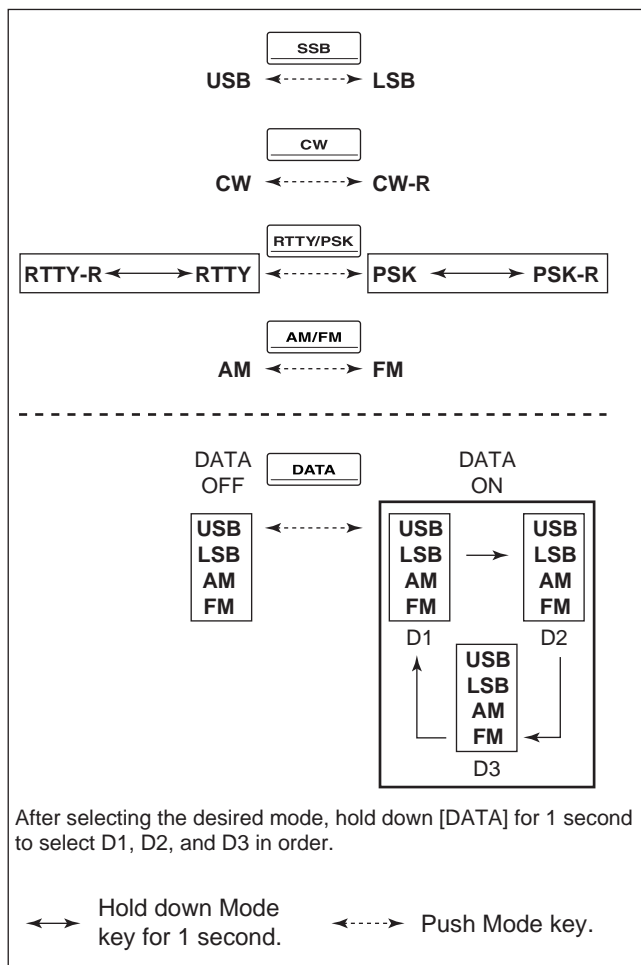

[DATA]

## ■ Selecting the Meter readout

The S/Rf meter readout during transmit can be selected from the following items.

- Push the Multi-function [METER](▶) key several times to select the desired meter item.
  - The selectable meters are:  
Po → SWR → ALC → COMP → V<sub>D</sub> → I<sub>D</sub> in that order.

<b>METER</b> Po	Displays the RF output power in watts.
<b>METER</b> SWR	Displays the VSWR on the transmission line.
<b>METER</b> ALC	Displays the ALC level. The ALC circuit begins to activate when the RF output power reaches a preset level.
<b>METER</b> COMP	Displays the compression level when the speech compressor is in use.
<b>METER</b> V <sub>D</sub>	Displays the drain current of the final amplifier MOS-FETs.
<b>METER</b> I <sub>D</sub>	Displays the drain terminal voltage of the final amplifier MOS-FETs.

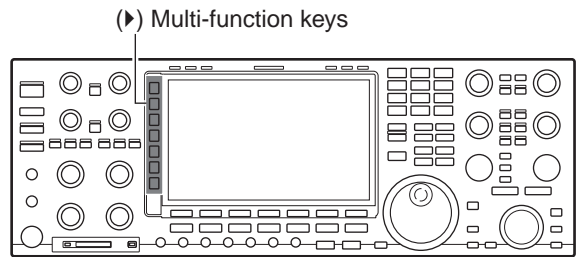
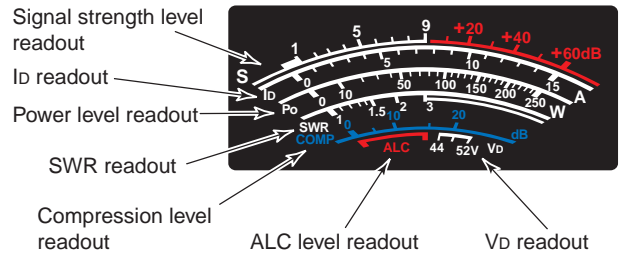

### ◇ Digital multi-function meter

The digital multi-function meter can simultaneously display all transmit parameters on the LCD display.

- Hold down the Multi-function [METER](▶) key for 1 second.
  - The digital multi-function meter is displayed.
  - Hold down the Multi-function [METER](▶) key for 1 second to turn OFF the meter.
- Push [P-HOLD](F) to turn ON the peak level hold function.
  - “P-HOLD” is displayed in the window title when the function is ON.

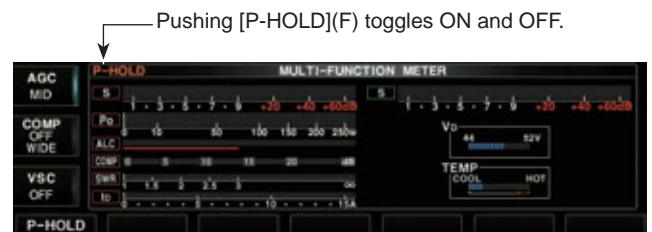

## 4 BASIC OPERATION

### ■ Selecting the Meter readout (Continued)

#### ◇ Selecting the meter type

A total of 3 meter types are selectable.

The meter types are Standard, Edgewise and Bar meters. Follow the instructions to select the meter type.

- ① Select the "Meter Type (Normal Screen)" item in the Display set screen.

**SET [F-7] ▾ DISPLAY [F-3] ▾ Meter Type (Normal screen)**

- ② Rotate [MAIN DIAL] to select the option.
- ③ Push [EXIT/SET] several times.
  - Exits the Set screen.

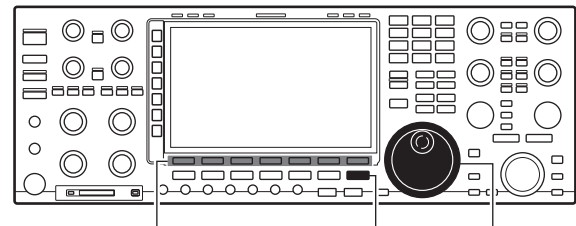

(F) Function keys [EXIT/SET] [MAIN DIAL]

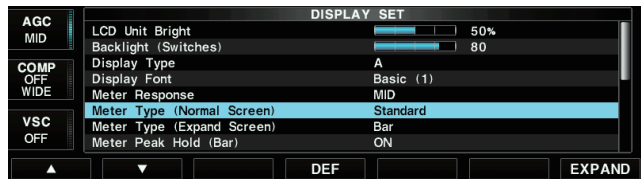

#### • Bar meter

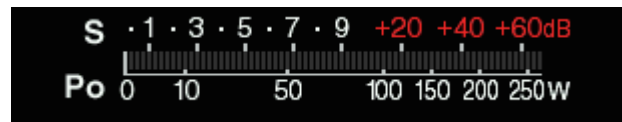

#### • Edgewise meter

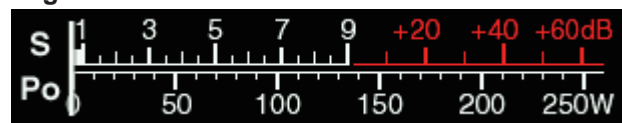

### ■ Dial lock function

The Dial lock function prevents frequency changes by accidental movement of the tuning dial. The lock function electronically locks the dial.

➔ Push [LOCK].

- Each push toggles the Dial lock function ON or OFF.
- The [LOCK] indicator lights when the function is ON.
- [MAIN DIAL] or [SUB DIAL] is locked when the function is ON.

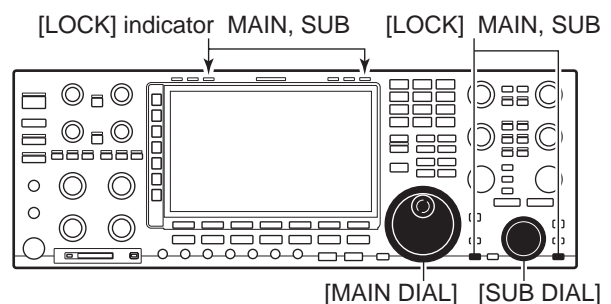

[LOCK] indicator MAIN, SUB [LOCK] MAIN, SUB  
[MAIN DIAL] [SUB DIAL]

Before transmitting, monitor your selected operating frequency to make sure you don't cause interference to other stations on the same frequency. It's good amateur practice to listen first, and then, even if nothing is heard, ask "is the frequency in use" once or twice, before you begin operating.

## Basic transmit operation

### Transmitting

- ① Push [TRANSMIT] or [PTT] (microphone) to transmit.
  - The Main band's [TX] indicator lights red.
  - When split operation is selected, the Sub band's [TX] indicator lights.
- ② Push [TRANSMIT] again or release [PTT] (microphone) to receive.

#### Adjusting the transmit output power

- ➔ Rotate [RF PWR].
  - Adjustable range: Less than 5 W to 200 W  
(AM mode: Less than 5 W to 50 W)

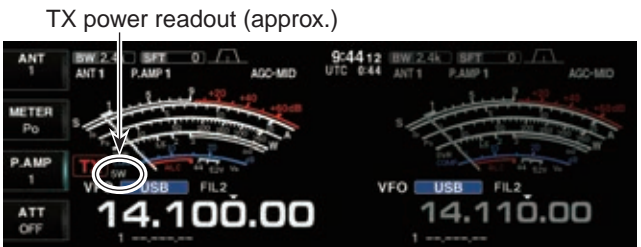
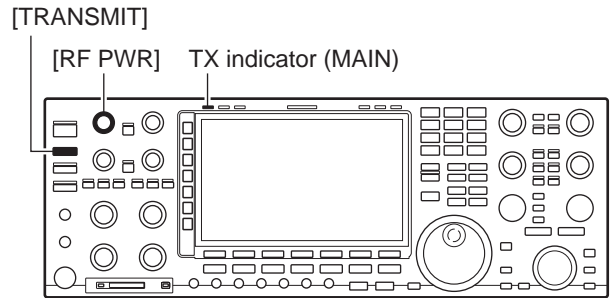

"<5W" is displayed when the power is set less than 5 W.

### Adjusting the microphone gain

- ① Push the Multi-function [METER](▶) key to select the ALC meter.
- ② Push [PTT] to transmit.
  - Talk into the microphone at your normal voice level.
- ③ While talking, rotate [MIC] so that the ALC meter reading doesn't go outside the ALC zone (see to the right).
- ④ Release [PTT] to receive.

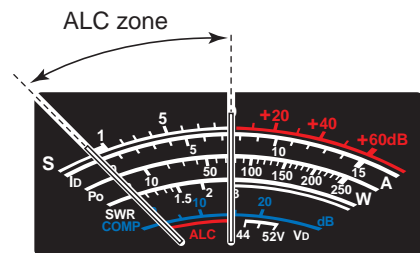
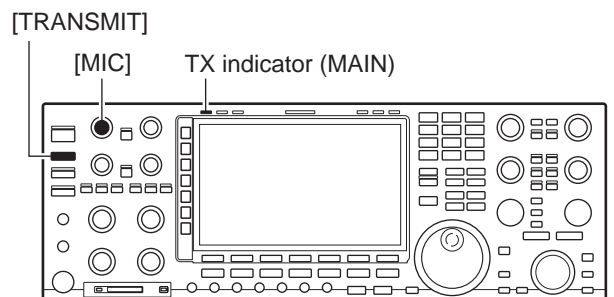



## 4 BASIC OPERATION

### ■ Basic transmit operation (Continued)

#### ◇ Adjusting the drive gain

The drive gain is active for all modes except SSB without speech compressor. The [DRIVE] control adjusts the amplifying gain at the driver stage.

- ① Push the Multi-function [METER](▶) key to select the ALC meter.
- ② Push [PTT] (microphone; SSB with [COMP] ON, AM or FM), key down (CW) or push [TRANSMIT] (RTTY or PSK) to transmit.
- ③ While speaking into the microphone, keying down or transmitting, rotate [DRIVE] so that the ALC meter reading swings within 30 to 50% of the ALC scale. (see to the right)
  - Speak into the microphone at your normal voice level.
- ④ Release [PTT], stop keying or push [TRANSMIT] again to receive.

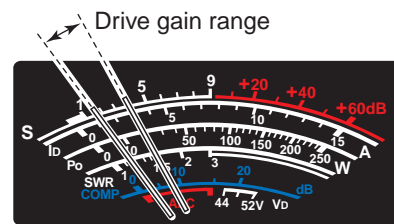
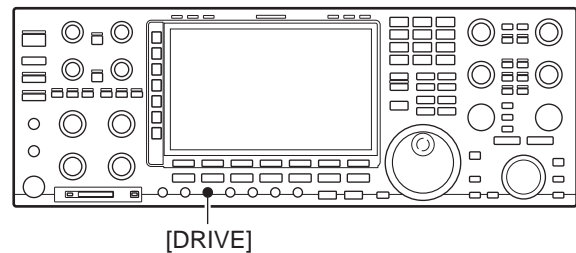

#### ◇ Transmit power limit

The transceiver can be set to a maximum output power on each operating band. You can separately set the maximum output power for operating in the DATA mode.

○ The Multi-function screens are OFF:

- ① Select the "TX Power Limit" item in the Others set screen.

**SET [F-7] ▾ OTHERS [F-5] ▾ TX Power Limit**

- ② Rotate [MAIN DIAL] to select "ON."
  - When ON is selected, the TX power limit is active.
- ③ Push [LIMIT](F).
  - The TX power limit screen is displayed.
- ④ Push the band key.
  - Select the desired band to set the TX power limit.
  - In the Phone mode (SSB, AM, or FM mode), push [DATA] to select the Data mode.
- ⑤ Rotate [MAIN DIAL] to set the maximum power.
- ⑥ Push [EXIT/SET] several times.
  - Exits the Set screen.

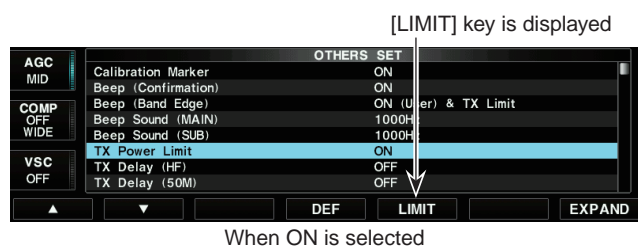
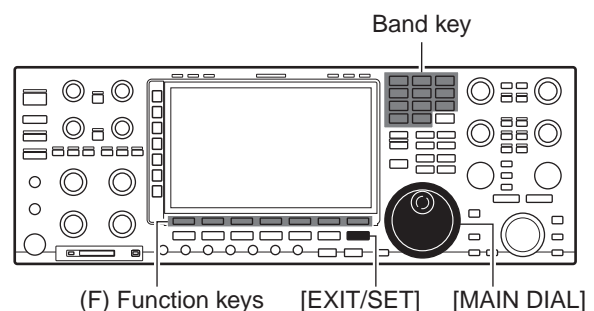

When ON is selected

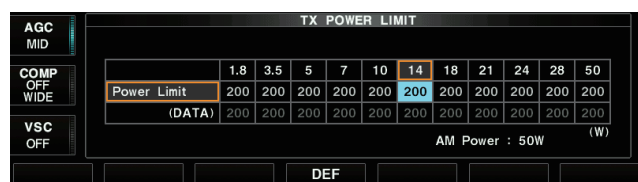

TX power limit screen



## ■ Band edge warning beep

This function allows you to hear a beep tone when you tune in or out of an amateur band's frequency range. A regular beep sounds when you tune into a range, and a lower tone error beep will sound when you tune out of a range.

Also, the TX indicator describes if the selected frequency is in or out of an amateur band, when an option other than "OFF" is set.

- A TX icon with a dotted rectangle, "TX" is displayed, instead of the regular "TX" TX icon, when a frequency outside of an amateur band frequency range is selected.

○ The Multi-function screens are OFF:

- ① Select the "Beep (Band Edge)" item in the Others set screen.

SET [F-7] > OTHERS [F-5] > **Beep (Band Edge)**

- ② Rotate [MAIN DIAL] to select the option.

• Band Edge Beep options:

- OFF: Band edge beep is OFF.
- ON (Default): When you tune into or out of the default amateur band's frequency range, a beep sounds. (default)
- ON (User): When you tune outside of, or back into a user programmed amateur band's frequency range, a beep sounds.
- ON (User) & TX Limit: When you tune outside of, or back into a user programmed amateur band's frequency range, a beep sounds. Transmission is also inhibited outside the programmed range.

- ③ Push [EXIT/SET] several times.

- Exits the Set screen.

### • About setting the User band edge

When the "ON (User)" or "ON (User) & TX Limit" option is selected, up to 30 band edges can be registered.

➡ Push [BAND](F).

- The Band edge screen is displayed, and then you can change, add, or delete the frequency range.

When the transverter function is in use, the band edge warning beep sounds at the default settings.

### • When no beep sounds:

When the "Beep Level" item in the Level set mode is set to 0%, no beep sounds. (p. 15-5)  
(SET [F-7] > LEVEL [F-1] > Beep Level)

▨ The beep output level can be set in the Level set mode.

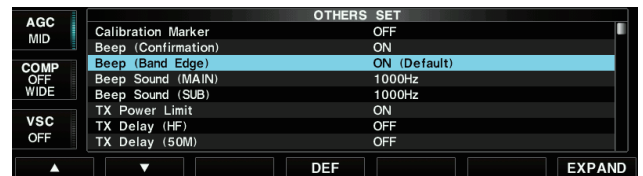
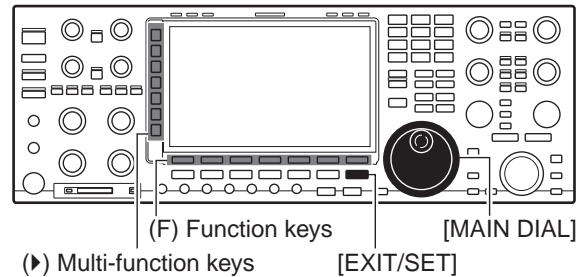

ON(Default) is selected

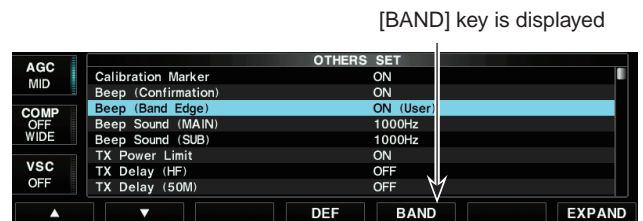

ON(User) is selected

### • Band edge screen

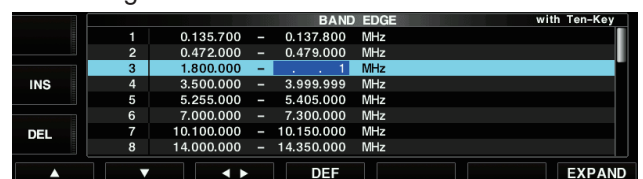

While setting the frequency range

See the next page for details of entering a frequency range on the Band edge screen.

## 4 BASIC OPERATION

### ■ Band edge warning beep (Continued)

#### ◇ Entering the user band edge

Up to 30 frequency ranges can be set.

- In the default setting, all frequency ranges that can be used, are entered.

When new band edge is entered, change or delete the band edge that includes the duplicate frequency range.

#### • Register the Band edge

○ The Multi-function screens are OFF:

- ① Select the “Beep (Band Edge)” item in the Others set screen.

**SET [F-7] ▸ OTHERS [F-5] ▸ Beep (Band Edge)**

- ② Rotate [MAIN DIAL] to select either the “ON (User)” or “ON (User) & TX Limit” option.

- The [BAND] key is displayed in the Function keys.
- When the “ON (User) & TX Limit” option is selected, the transmit ranges are also limited in the ranges you can enter.

- ③ Push [BAND](F).

- The Band edge screen is displayed.

- ④ Push [▲](F) or [▼](F) to select the band edge that is changed or deleted.

- Hold down to continuously move the lines.
- Push [◀▶](F) to toggle between the entry cells of the upper and lower band edge frequencies.
- Push [INS](▶) to insert a new blank line.
- Hold down [DEL](▶) for 1 second to delete the selected line.
- Hold down [DEF](F) for 1 second to reset all band edge frequencies.

The Band edge initialize screen appears as shown to the right, then push [OK](F) to reset all frequencies.

- ⑤ Enter the Band edge frequencies with the keypad.

- ① Push [F-INP] to enter the frequency input mode.

- ② Enter the desired frequency.

- ③ Push [ENT] to save the frequency.

- Push [.] to input decimal point (“.”) between the MHz and kHz digits.

- Enter each channel from left to right and each frequency must be higher than the preceding frequency.

- A frequency that is duplicated, or out of an amateur band, cannot be entered.

- ⑥ Push [EXIT/SET] several times.

- Exits the Set screen.

**NOTE:** The duplicated frequency with the already registered frequency range, cannot be registered.

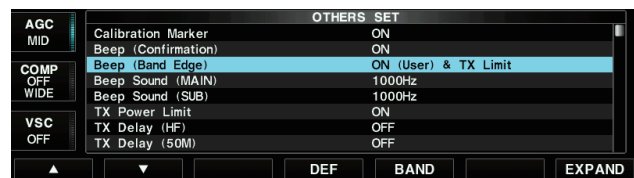
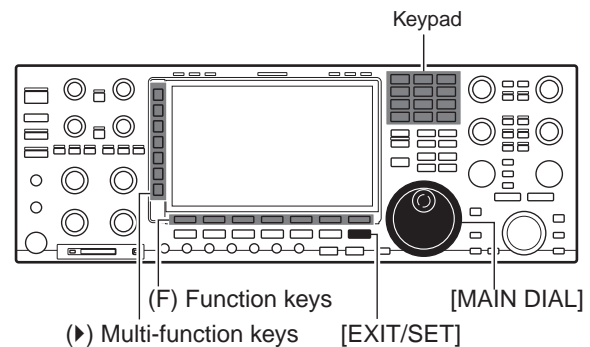

ON (User) & TX Limit is selected

#### • Band edge screen



While setting the frequency range

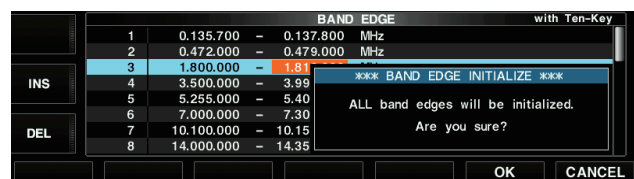

Confirmation window



- **The Multi-function keys for entering the frequency range:**

When inserting a blank line, push [▲](F) or [▼](F) to select the line below the one where you want to insert a new line. And then push [INS](▶).

- If 30 band edges are already entered, a new line cannot be inserted.

To delete a frequency range, push [▲](F) or [▼](F) to select the line that you want to delete. And then hold down [DEL](▶) for 1 second.

- Be careful! The deleted frequency range cannot be recalled. However, hold down [DEF](F) for 1 second to call the confirmation window and to reset all band edges to their default settings.

Multi-function keys	Description
	Insert a line above the selected line
	Delete the selected frequency range

## ■ About the 5 MHz frequency band operation (USA version only)

Operation on the 5 MHz frequency band is allowed on 5 discrete frequencies and must adhere to the following:

- The USB, USB Data, CW, and PSK modes.
- Maximum of 100 watts ERP (Effective Radiated Power)
- 2.8 kHz bandwidth (maximum)

It is your responsibility to set all controls so that transmission in this frequency band meets the stringent conditions under which amateur operations may use these frequencies.

**NOTE:** We recommend that you store these frequencies, modes and filter settings into memory channels, for easy recall.

To assist you in operating within the rules specified by the FCC, transmission is illegal on any frequencies other than the five shown in the tables below.

### • For the USB and USB Data modes

The FCC specifies center frequencies on the 5 MHz frequency band. However, the transceiver displays carrier frequency. Therefore, tune the transceiver to 1.5 kHz below the specified FCC channel center frequency.

Transceiver Displayed Frequency	FCC Channel Center Frequency
5.33050 MHz	5.33200 MHz
5.34650 MHz	5.34800 MHz
5.35700 MHz	5.35850 MHz
5.37150 MHz	5.37300 MHz
5.40350 MHz	5.40500 MHz

### • For the CW and PSK modes

The transceiver displays the center frequency. Therefore, tune the transceiver to the specified FCC channel frequency when you operate in these modes.

Transceiver Displayed Frequency	FCC Channel Center Frequency
5.33200 MHz	5.33200 MHz
5.34800 MHz	5.34800 MHz
5.35850 MHz	5.35850 MHz
5.37300 MHz	5.37300 MHz
5.40500 MHz	5.40500 MHz

■ Convenient functions for Receive .....	5-2
■ Convenient functions for Transmit .....	5-3
■ Operating SSB .....	5-4
■ Operating CW .....	5-5
◇ About the CW pitch control .....	5-6
◇ APF (Audio Peak Filter) operation .....	5-6
◇ Adjusting the Key speed .....	5-7
◇ About the CW reverse mode .....	5-7
◇ CW side tone function .....	5-7
◇ About 137 kHz band operation (Europe version only) .....	5-8
■ Electronic keyer functions .....	5-9
◇ Memory keyer screen .....	5-10
◇ Editing a Keyer memory .....	5-11
◇ Contest number set mode .....	5-12
◇ Keyer set mode .....	5-13
■ Operating RTTY (FSK) .....	5-14
◇ About the RTTY reverse mode .....	5-15
◇ Twin peak filter .....	5-15
◇ Functions for the RTTY decoder display .....	5-16
◇ Setting the decoder threshold level.....	5-17
◇ RTTY memory transmission .....	5-17
◇ Automatic transmission/reception setting .....	5-18
◇ Editing the RTTY memory .....	5-19
◇ Turning ON the RTTY log.....	5-20
◇ Confirm the RTTY log contents .....	5-21
◇ RTTY decode set mode .....	5-22
■ Operating PSK .....	5-24
◇ Vector indicator and Waterfall display.....	5-25
◇ Functions for the PSK decoder display .....	5-26
◇ About the BPSK and QPSK modes .....	5-27
◇ About the BPSK31 and BPSK63 modes .....	5-27
◇ Setting the decoder threshold level.....	5-28
◇ About the PSK reverse mode .....	5-28
◇ AFC/NET functions .....	5-28
◇ PSK memory transmission .....	5-29
◇ Automatic transmission/reception setting .....	5-30
◇ Editing the PSK memory .....	5-31
◇ Turning ON the PSK log .....	5-32
◇ Confirm the PSK log contents .....	5-33
◇ PSK decode set mode .....	5-34
■ Operating AM or FM .....	5-36
■ Repeater operation .....	5-37
◇ Checking the repeater input signal .....	5-37
◇ Repeater tone frequency setting.....	5-38
■ Tone squelch operation.....	5-39
■ Data mode (AFSK) operation .....	5-40

## 5 RECEIVE AND TRANSMIT

This section, describes particular operations for each operating mode, such as operating the Memory keyer in the CW mode, or operating the Encoder or Decoder in the RTTY or PSK mode.

If you use functions that are described in Section 6: Scope operation, Section 7: Functions for Receive, or Section 8: Functions for Transmit, you can operate the transceiver more conveniently.

### ■ Convenient functions for Receive

#### ○ All operating modes

##### Preamplifier (p. 7-2)

The preamp amplifies received signals in the receiver front end, to improve the S/N ratio and sensitivity. When receiving weak signals, select to P.AMP 1 or P.AMP 2.

- Push [P.AMP] several times to turn ON preamp 1 or preamp 2 or, to turn OFF the preamp.
  - “P.AMP1” or “P.AMP2” is displayed when preamp 1 or preamp 2 is ON. (The Main and Sub bands have independent preamp controls.)

##### Attenuator (p. 7-2)

The attenuator prevents a desired signal from becoming distorted when very strong signals are near the frequency, or when very strong electric fields, such as from broadcasting stations, are near your location.

- Push [ATT] several times to set the attenuator in 6 dB steps.
  - Hold down [ATT] for 1 second to set the attenuator in 3 dB steps.
  - “ATT” and the attenuation level are displayed when the attenuator is ON.

##### Notch filter (p. 7-13)

The Auto notch function uses DSP to automatically attenuates beat tones, tuning signals, and so on, even if they are moving.

The Manual notch can be set to attenuate a frequency by rotating the [NOTCH] control.

- When the SSB or AM mode is selected:
  - Auto notch or Manual notch can be used.
- When the CW, RTTY, or PSK mode is selected:
  - Only the Manual notch can be used.
- When the FM mode is selected:
  - Only the Auto notch can be used.
- Push the [NOTCH] key to turn the Auto or Manual notch function ON or OFF.
  - Rotate the [NOTCH] control to set the “valley” frequency for the Manual notch function.
  - The Notch indicator (above the [NOTCH] key) lights when either the Auto or Manual notch function is ON.

#### ○ SSB/CW/RTTY/PSK/AM modes

##### Noise blanker (p. 7-11)

The noise blanker eliminates pulse-type noise such as the noise from car ignitions.

- Push the [NB] key to turn the noise blanker ON or OFF, and then rotate the [NB] control to adjust the threshold level.
  - The Noise blanker indicator (above the [NB] key) lights when the noise blanker is ON.
  - Hold down the [NB] key for 1 second to enter the NB screen.

##### Noise reduction (p. 7-12)

The Noise reduction function reduces random noise components and enhances desired signals that are buried in noise. The DSP does the random noise reduction function.

- Push the [NR] key to turn the Noise reduction ON or OFF.
  - Rotate the [NR] control to adjust the noise reduction level.
  - The Noise reduction indicator (above the [NR] key) lights when the Noise reduction is ON.

##### AGC (p. 7-4)

The AGC (Auto Gain Control) controls receiver gain to produce a constant audio output level even when the received signal strength greatly varies.

##### Twin PBT (p. 7-5)

The PBT (Passband Tuning) electronically narrows the IF passband width by shifting the IF frequency to slightly outside of the IF filter passband, to reject interference. The transceiver uses DSP for the PBT function. Moving both the [TWIN PBT] controls to the same position shifts the IF.

- Rotate the [TWIN PBT] controls (inner/outer).
  - Hold down [PBT CLEAR] for 1 second to clear the settings.

## ■ Convenient functions for Receive (Continued)

### ○ SSB data/CW/RTTY/PSK modes

#### 1/4 function (p. 4-9)

When operating in the SSB data, CW, RTTY or PSK mode, the 1/4 tuning function is selectable. When the function is ON, the Dial speed is reduced to 1/4 of the normal speed, for finer tuning control.

➔ Push the Multi-function [1/4](▶) key to turn the 1/4 function ON or OFF.

- “1/4” is displayed when the function is ON.

### ○ CW/AM modes

#### Auto tuning function (p. 7-14)

➔ Push [AUTO TUNE] to turn ON the Auto tuning function.

- When the CW mode is selected:  
The transceiver automatically tunes the desired signal within a  $\pm 500$  Hz range.
- When the AM mode is selected:  
The transceiver automatically tunes the desired signal within a  $\pm 5$  kHz range.

### IMPORTANT!

When receiving a weak signal, or receiving a signal with interference, the Automatic tuning function may not tune, or may tune to an undesired signal.

## ■ Convenient functions for Transmit

### ○ SSB/AM/FM modes

#### VOX function (p. 8-2)

The VOX (Voice-Operated Transmission) function switches between transmit and receive with your voice. This function provides hands-free operation.

➔ Push [VOX/BK-IN] to turn the VOX function ON or OFF.

- “VOX” is displayed when the VOX function is ON.

#### Transmit monitor (p. 8-5)

The Monitor function allows you to monitor your transmit signals.

#### Audio tone control (p. 15-4)

You can adjust the transmit voice characteristics (Bass or Treble).

### ○ SSB mode

#### Speech compressor (p. 8-6)

The speech compressor increases average RF output power, improving signal strength and readability.

➔ Push the Multi-function [COMP](▶) key to turn the Speech compressor ON or OFF.

#### Transmit filter width (p. 8-6)

➔ Hold down the Multi-function [COMP](▶) key for 1 second to select the compression bandwidth between Wide, Mid, and Narrow.

### ○ CW mode

#### Break-in function (p. 8-4)

The break-in function is used to automatically toggle the transceiver between transmit and receive when keying. The transceiver is capable of full break-in or semi break-in CW operation.

- Semi-break-in operation:  
In the semi break-in mode, the transceiver transmits when keying, then automatically returns to receive after a preset time after you stop keying.
  - Full break-in operation:  
In the full break-in mode, the transceiver automatically transmits while keying and returns to receive immediately after you stop keying.
- ➔ Push [VOX/BK-IN] several times to select the break-in OFF, semi break-in or full break-in.
- “BK IN” or “F-BK IN” is displayed when the Semi break-in or Full break-in function is ON.



## ■ Operating SSB

Before transmitting, monitor your selected operating frequency to make sure you don't cause interference to other stations on the same frequency.

- ① Push a band key to select desired band.
- ② Push the Mode key [SSB] to select the SSB mode.
  - "USB" or "LSB" is displayed.
  - Below 10 MHz LSB is automatically selected, above 10 MHz USB is automatically selected.
  - Push [SSB] again to select the LSB or USB mode.
- ③ Rotate [MAIN DIAL] to tune a desired signal.
  - The S-meter indicates received signal strength when a signal is received.
- ④ Rotate [AF] to set the audio to a comfortable listening level.
- ⑤ Rotate [RF PWR] to adjust the output power.
  - The TX power readout displays the setting level.
- ⑥ Push the Multi-function [METER](▶) key to select the ALC meter.
- ⑦ Transmit.
  - Push [TRANSMIT] or [PTT] (microphone).
  - The [TX] indicator lights red.
- ⑧ Rotate [MIC] to adjust the microphone gain.
  - While speaking into the microphone at your normal voice level, adjust the microphone gain so that the ALC meter reading swings within 30 to 50% of the ALC scale.
- ⑨ After your transmission is finished, returns to receive.
  - Push [TRANSMIT] or release [PTT].

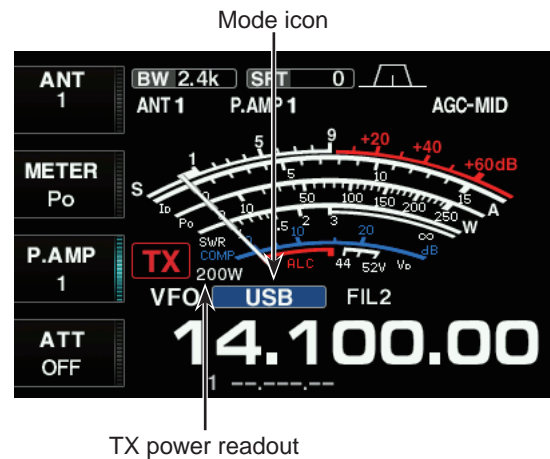
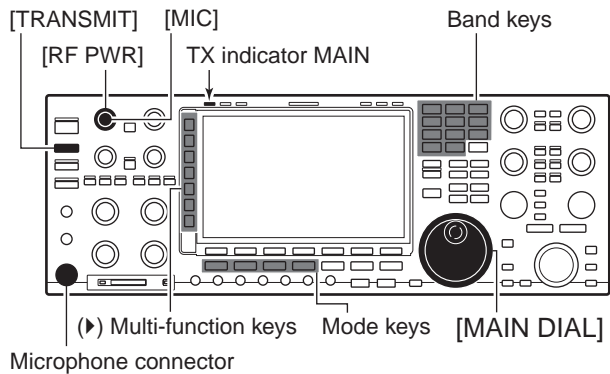



## ■ Operating CW

Before transmitting, monitor your selected operating frequency to make sure you don't cause interference to other stations on the same frequency.

- ① Push a band key to select the desired band.
- ② Push the Mode key [CW] to select the CW mode.
  - "CW" or "CW-R" is displayed.
  - Push [CW] again to select the CW or CW-R mode.
  - The carrier point of the CW mode is the LSB side by default. You can change it to the USB side in the "CW Normal Side" item of the Others set screen. (SET [F-7] > OTHERS [F-5] > CW Normal Side)
- ③ Rotate [MAIN DIAL] to tune a desired signal.
  - Try to match the specified signal's tone to the side tone frequency.
  - The S-meter indicates the received signal strength when signal is received.
- ④ Rotate [AF] to set the audio to a comfortable listening level.
- ⑤ Rotate [RF PWR] to adjust the output power.
  - The TX power readout displays the setting level.
- ⑥ Transmit.
  - Push [TRANSMIT].
  - The [TX] indicator lights red.
- ⑦ Use the electric keyer or a paddle to key your CW signals.
  - The power meter indicates transmitted CW output power.
- ⑧ Push the Multi-function [METER](▶) key to select the ALC meter.
- ⑨ Rotate [DRIVE] to adjust the Drive gain.
  - While keying, adjust the Drive gain so that the ALC meter reading swings within 30 to 50% of the ALC scale.
  - If the ALC meter reading goes outside the ALC zone, the rise time becomes faster than the setting time in the Keyer set screen (p. 5-13).
- ⑩ After your transmission is finished, returns to receive.
  - Push [TRANSMIT].

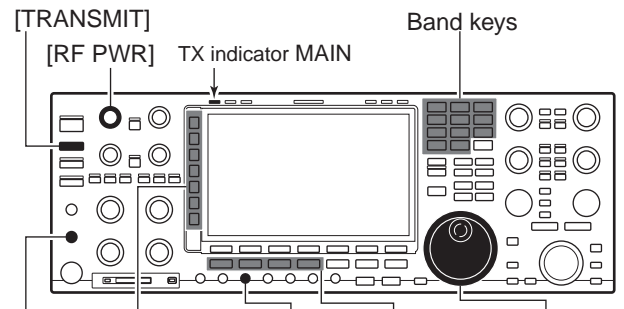

(▶) Multi-function keys [DRIVE] Mode keys [MAIN DIAL]  
Connect a paddle (or connect an Electric key or external electric keyer to the [KEY] jack on the Rear panel).

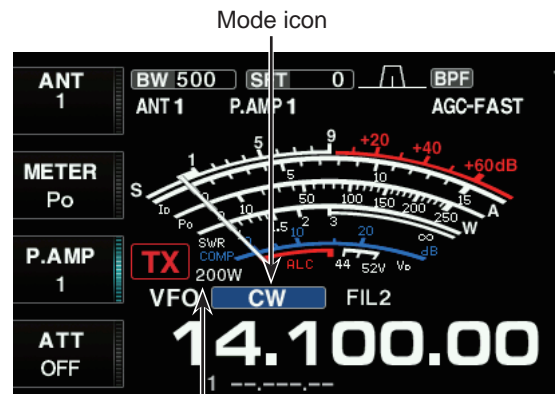

## 5 RECEIVE AND TRANSMIT

### ■ Operating CW (Continued)

#### ◇ About the CW pitch control

The received CW audio pitch and CW side tone can be adjusted to suit your preference. This does not change the operating frequency.

- ① Rotate [CW PITCH] to suit your preference.
  - Adjustable between 300 to 900 Hz in 5 Hz steps.
- ② Hold down [FILTER] for 1 second.
  - The Filter screen is displayed.
  - The Filter screen graphically displays the CW pitch.

Digital IF filter		Filter screen
Passband width	Below 500 Hz	The CW pitch frequency is changed in 5 Hz steps. • “BPF” is displayed.
	Above 600 Hz	The CW pitch frequency is changed in 25 Hz steps. • “BPF” disappears.

- ③ Push [EXIT/SET].
  - Exits the Set screen.

#### ◇ APF (Audio Peak Filter) operation

The APF changes the audio frequency response by boosting a particular frequency to enhance a desired CW signal.

- ① In the CW mode, push [APF/TPF] to turn the audio peak filter ON or OFF.
  - “APF” is displayed and the [APF/TPF] indicator above this key lights white.
- ② Hold down [APF/TPF] for 1 second.
  - Hold down [APF/TPF] for 1 second selects the Audio filter width.

APF type*	Filter width
SOFT	WIDE, MID, NAR
SHARP	320 Hz, 160 Hz, 80 Hz

\* The audio filter shape is also selectable between “SOFT” and “SHARP” in the “APF TYPE” item of the Others set screen. (p. 15-14)  
(SET [F-7] > OTHERS [F-5] > APF TYPE)

- ③ Rotate the [DIGI-SEL] control to suit your preference.
  - The peak frequency can be adjusted with the [DIGI-SEL] control when “APF” is selected in the “DIGI-SEL VR Operation” item of the Others set screen (p. 15-15).  
(SET [F-7] > OTHERS [F-5] > DIGI-SEL VR Operation)

The APF audio level can be adjusted in the Level set screen (p. 15-5).

(SET [F-7] > LEVEL [F-1] > APF AF LEVEL)

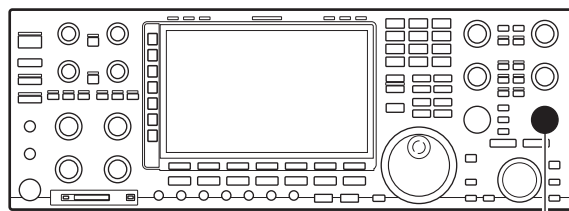

[CW PITCH]

#### • Filter screen



CW PITCH display (Example: 700 Hz)

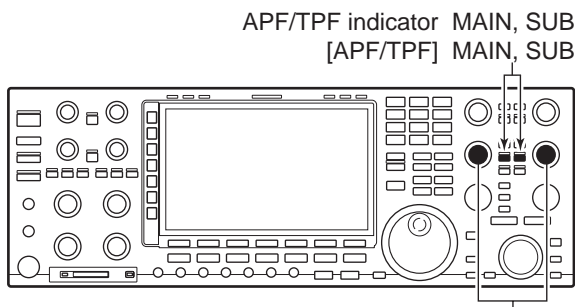

[DIGI-SEL] MAIN, SUB

### ◇ Adjusting the Key speed

When using the internal electric keyer, you can adjust the Key speed.

➔ Rotate [KEY SPEED].

- The key speed popup appears. You can confirm the adjusted speed by numeral.
- Selectable speed: 6 ~ 48 WPM (Word Per Minutes).

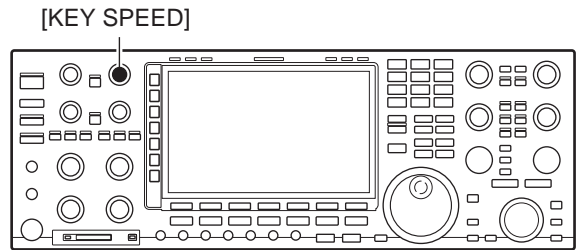

Key speed popup

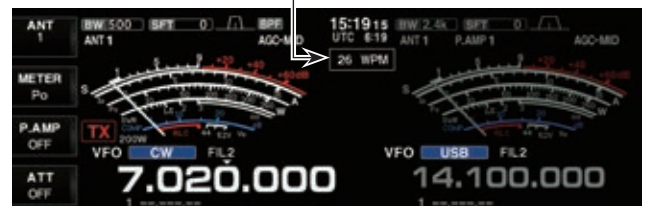

### ◇ About the CW reverse mode

The CW-R (CW Reverse) mode uses the opposite side band to receive CW signals.

Use when interfering signals are near a desired signal and you want to use CW-R to reduce the interference.

➔ In the CW mode, push [CW] to select the CW and CW-R mode.

The carrier point of the CW mode is the LSB side by default. You can change it to the USB side in the "CW Normal Side" item of the Others set screen.

(SET [F-7] > OTHERS [F-5] > CW Normal Side)

- When this setting is set to "USB," the CW and CW-R modes are reversed.

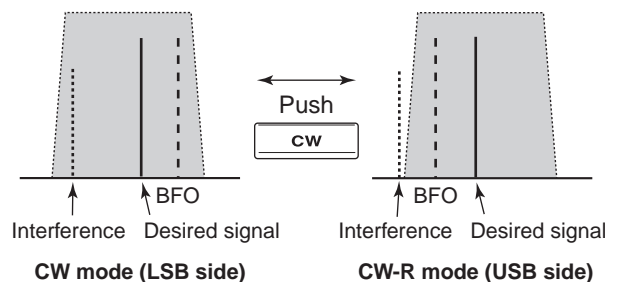

### ◇ CW side tone function

When the transceiver is in standby (and the break-in function is OFF— p. 8-4) you can listen to the CW side tone without actually transmitting.

This allows you to match your transmit frequency exactly to another station's by matching the audio tone. You can also use the CW side tone (be sure to turn OFF break-in!) to practice CW sending. The CW side tone level can be adjusted in the Level set mode (p. 15-5).

(SET [F-7] > LEVEL [F-1] > Side Tone Level)

## 5 RECEIVE AND TRANSMIT

### ■ Operating CW (Continued)

#### ◇ About 137 kHz band operation (Europe version only)

The 137 kHz band, between the 135.7 kHz to 137.8 kHz, operation in the CW mode is optionally available. The RF signal from [X-VERTER] is used for the 137 kHz band operation, and an external amplifier unit is necessary.

See the connection diagram below for reference.

#### • Connection diagram for 137 kHz band operation

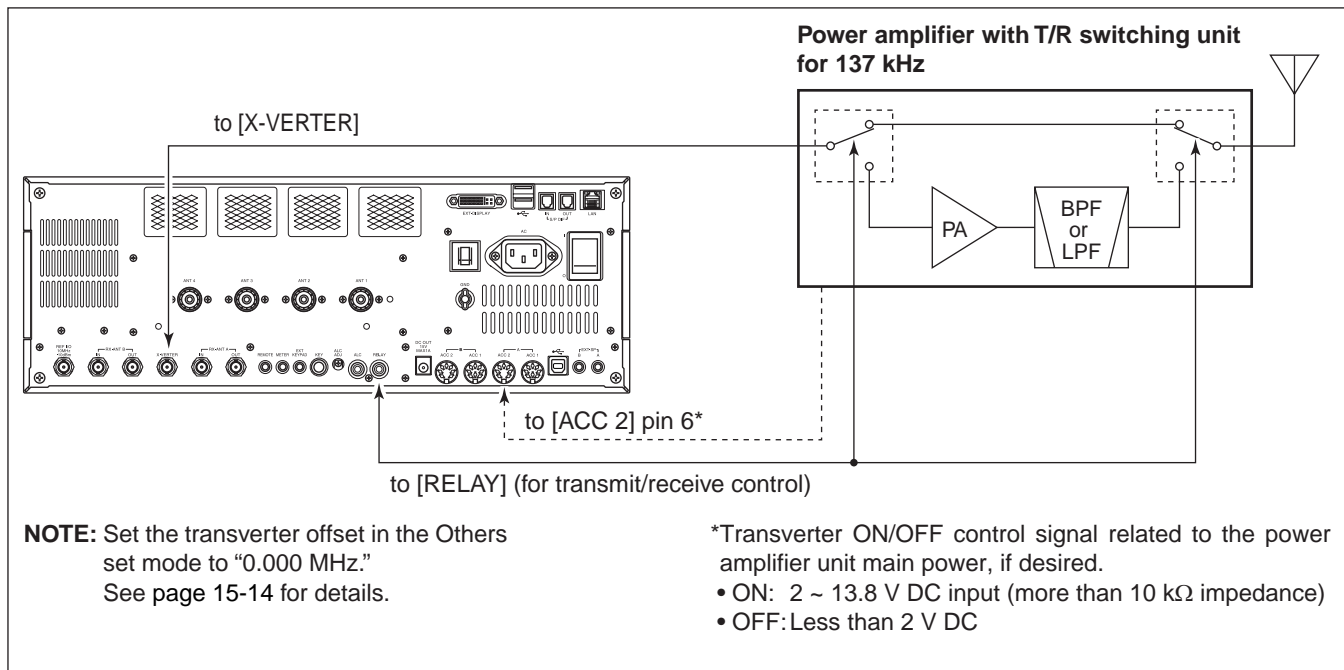

## Electronic keyer functions

This transceiver has a number of convenient functions for the built-in electronic keyer.

- The Multi-function screens are OFF:
- ① Push the Mode key [CW].
- ② Push [KEYER](F).

  - The Memory keyer screen is displayed.

- ③ Push [EXIT/SET].

  - The Memory keyer menu screen is displayed.

- ④ Push one of the Function keys ([F-1] to [F-4]).

  - The selected menu screen is displayed. See the diagram below.
  - To return to the Memory keyer menu screen, push [EXIT/SET].

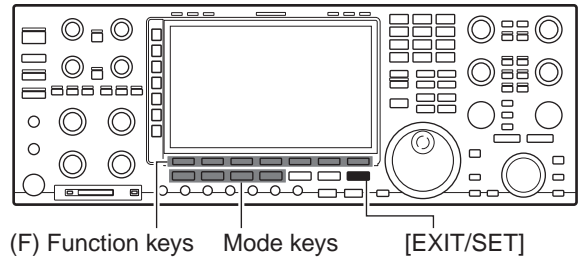

• Memory keyer screen (p. 5-10)



• Keyer edit screen (p. 5-11)

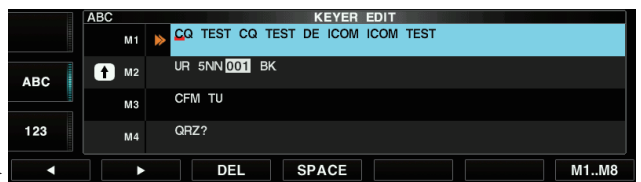

• Memory keyer menu screen

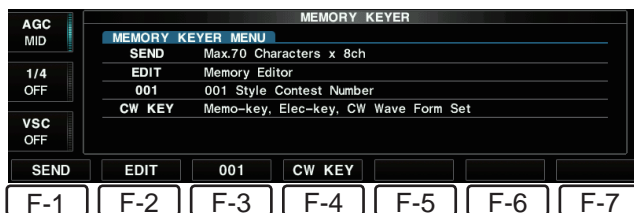

• Keyer 001 screen (p. 5-12)

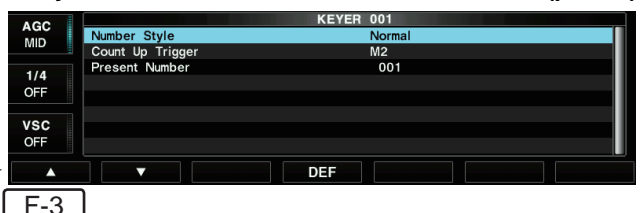

• Keyer CW-Key screen (p. 5-13)

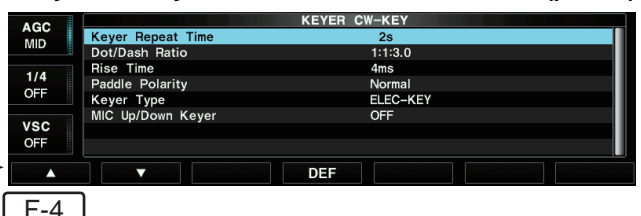

## 5 RECEIVE AND TRANSMIT

### ■ Electronic keyer functions (Continued)

#### ◇ Memory keyer screen

Preset characters can be sent using the Memory keyer screen. Contents of the memory keyer are entered in the Keyer edit screen.

##### • Transmitting

- The Multi-function screens are OFF:
- ① Push the Mode key [CW].
- ② Push [KEYER](F).
  - The Memory keyer screen is displayed.
- ③ Push [1-4/5-8] to select the Memory bank.
  - M5 ~ M8 are blank by default, edit the contents to use these memories.
- ④ Push [TRANSMIT], or turn ON the Break-in function (p. 8-4).
- ⑤ Push one of the function keys [M1] ~ [M4] or [M5]~[M8].
  - Send the selected Memory keyer content.
  - M1 ~ M8 and the contents are highlighted orange.
  - Holding down for 1 second to repeatedly send the contents.
  - Set the repeat interval in the “Keyer Repeat Time” item of the Keyer set screen. (p. 5-13)
  - To cancel sending the content, push any function key.

##### Count up trigger

The contest number counter advances each time the contents are sent. The counter is 4 digits.

- The count up trigger can be assigned in the Keyer 001 screen. (p. 5-12)
- The arrow icon indicates the assigned memory keyer. In the default setting, Memory keyer M2 is assigned.
- Push [-1](F) to reduce the contest number advances by one before sending the Memory keyer contents to a station a second time.

- ⑥ After your transmission is finished, returns to receive.
  - Push [TRANSMIT].
- ⑦ Push [EXIT/SET].
  - Exits the Memory keyer screen.

##### ✓ For your convenience

When an external keypad or PC keyboard is connected, the preset contents, M1 ~ M4 or M5 ~ M8, can be transmitted without selecting the Memory keyer screen.

See pages 3-6 and 15-16 for details.

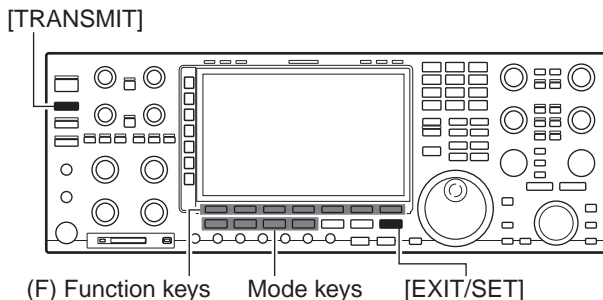

##### • Memory keyer screen (SEND)



##### • Functions in the Memory keyer screen

Function	Action	
M1 ~ M8	Push	Sends the Memory keyer content.
	Hold down	Repeatedly sends the Memory keyer content.
-1	Reduces the contest number counter advances by one. <ul style="list-style-type: none"> <li>• You can change or reset the number in the Keyer 001 screen.</li> </ul>	
1-4/5-8	Selects the Memory bank. <ul style="list-style-type: none"> <li>• Toggles between M1 ~ M4 and M5 ~ M8.</li> </ul>	

## ◇ Editing a Keyer memory

The contents of the Memory keyer memories can be set in the Keyer edit screen. The Memory keyer can memorize and retransmit eight CW key codes for often-used CW sentences, contest serial numbers, and so on. The capacity of the Memory keyer is 70 characters per memory.

### • Programming contents

○ The Multi-function screens are OFF:

- ① Push [KEYER](F).
  - The Memory keyer screen is displayed.
- ② Display the Memory keyer menu screen, then push [EDIT](F).
  - The Keyer edit screen is displayed.
- ③ Push [M1..M8] several times.
  - Push [M1..M8] to select the memory keyer. (M1 → M2 → M3 → ... → M8 → M1)
- ④ Rotate [MAIN DIAL] to select the character.

Keys	Input mode/Action
[ABC](▶)	Selects the Alphabet input mode.
[123](▶)	Selects the Number input mode. • Push to toggle between [123](▶) and [Symbol](▶).
[Symbol](▶)	Selects the Symbol input mode.
[DEL](F)	Deletes a character.
[SPACE](F)	Enters a space.

• When a keyboard is connected to the [USB A] port on the rear panel, you can directly enter the contents using the keyboard.

• Push keypad to enter 0 ~ 9 or a period (.).

- ⑤ Push [◀](F) or [▶](F) to move the cursor.
- ⑥ Repeat steps ④ and ⑤ to input the desired characters.
- ⑦ After editing the contents, push [EXIT/SET].
  - Exits the Keyer edit screen.

• Selectable characters (with [MAIN DIAL])

ABC	A B C D E F G H I J K L M N O P Q R S T U V W X Y Z
123	1 2 3 4 5 6 7 8 9 0
Symbol	/ ? ^ . , @ *

### About the Symbols:

“^” is used to transmit a string of characters with no inter-character space. Put a “^” before a text string such as ^AR, and the string “AR” is sent with no space.

“\*” is used to insert the CW contest number. The number automatically advances by 1. This function is available for only one memory keyer channel at a time. “\*” is used in memory keyer channel M2 by default.

(▶) Multi-function keys

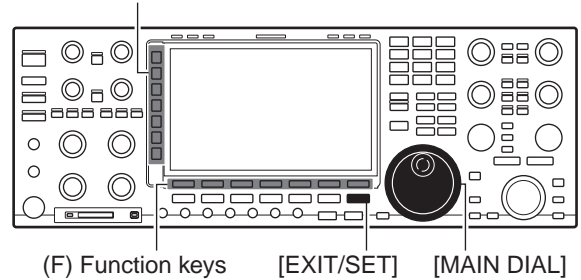

### • Keyer edit screen

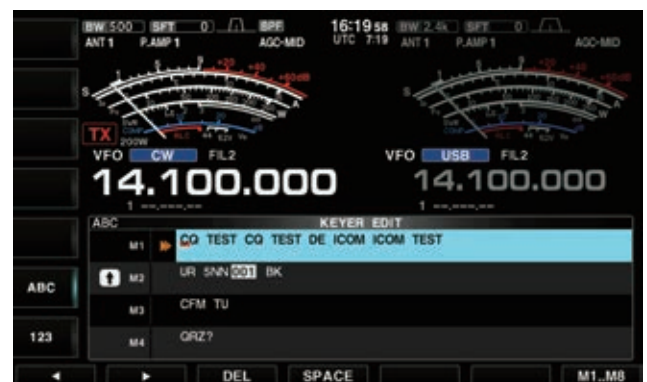

### • Example: Entering “QSL TU DE JA3YUA TEST” into the Memory keyer M3



### • Preset contents

CH	Contents
M1	CQ TEST CQ TEST DE ICOM ICOM TEST
M2	UR 5NN* BK
M3	CFM TU
M4	QRZ?



## 5 RECEIVE AND TRANSMIT

### ■ Electronic keyer functions (Continued)

#### ◇ Contest number set mode

This mode is used to set the Number style, Count up trigger and Present number.

##### • Setting contents

○ The Multi-function screens are OFF:

- ① Push [KEYER](F).
  - The Memory keyer screen is displayed.
- ② Display the Memory keyer menu screen, then push [001](F).

[EXIT/SET] ▾ 001 [F-3]

- The Keyer 001 screen is displayed.
- ③ Push [▲](F) or [▼](F) to select the item.
- ④ Rotate [MAIN DIAL] to set the desired setting.
  - Hold down [DEF](F) for 1 second to select the default setting.
- ⑤ Push [EXIT/SET].
  - Exits the Keyer 001 screen.

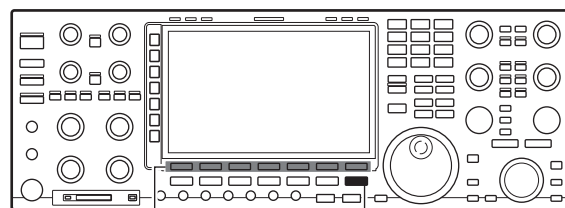

(F) Function keys

[EXIT/SET]

##### • Keyer 001 screen

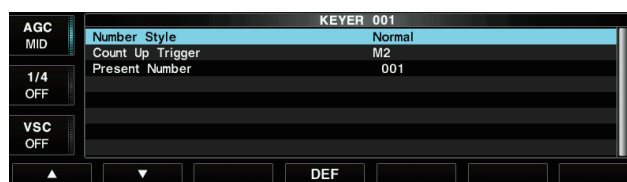

#### Number Style (Default: Normal)

This item sets the numbering system used for contest (serial) numbers— normal or short morse numbers.

- Normal: Does not use short morse numbers
- 190→ANO: Sets 1 as A, 9 as N and 0 as O.
- 190→ANT: Sets 1 as A, 9 as N and 0 as T.
- 90→ NO: Sets 9 as N and 0 as O.
- 90→ NT: Sets 9 as N and 0 as T.

#### Count Up Trigger (Default: M2)

This selects which of the four memories will contain the contest serial number exchange. The count up trigger allows the serial number to be automatically incremented after each complete serial number exchange is sent.

- Selectable memory: M1 ~ M8.

#### Present Number (Default: 001)

This item shows the current number for the count-up trigger channel set above.

- Rotate [MAIN DIAL] to change the number (001 ~ 9999), or hold down [001CLR](F) for 1 second to reset the current number to 001.

### ◇ Keyer set mode

This Set mode is used to set the memory keyer repeat time, dash weight, paddle specifications, keyer type, and so on.

#### • Setting contents

- The Multi-function screens are OFF:
- ① Push [KEYER](F).
  - The Memory keyer screen is displayed.
- ② Display the Memory keyer menu screen, then push [CW KEY](F).
  - The Keyer CW-Key screen is displayed.
- ③ Push [▲](F) or [▼](F) to select the item.
- ④ Rotate [MAIN DIAL] to set the desired setting.
  - Hold down [DEF](F) for 1 second to select the default setting.
- ⑤ Push [EXIT/SET].
  - Exits the Keyer CW-Key screen.

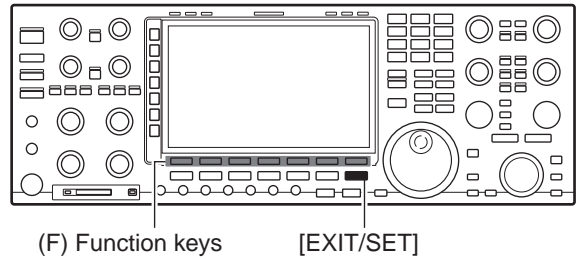

#### • Keyer CW-Key screen

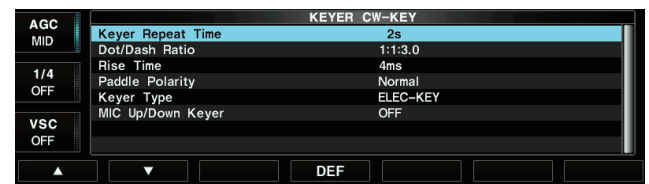

### Keyer Repeat Time (Default: 2s)

When sending CW using the repeat timer, set the time between transmission.

- Selectable time: 1 ~ 60 seconds in 1 second steps.

### Dot/Dash Ratio (Default: 1:1:3.0)

Sets the dot/dash ratio.

- Selectable ratio: 1:1:2.8 ~ 1:1:4.5 in 0.1 steps.

#### Keying weight example: Morse code "K"

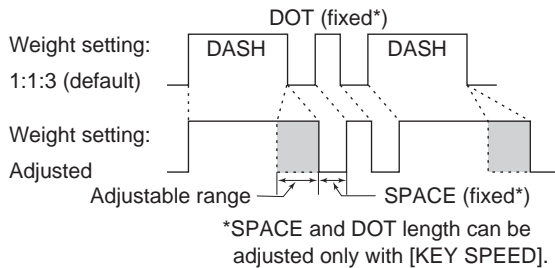

### Rise Time (Default: 4ms)

Sets the rise time of the transmitted CW envelope.

- Selectable time: 2, 4, 6 or 8 milliseconds.

#### • About rise time

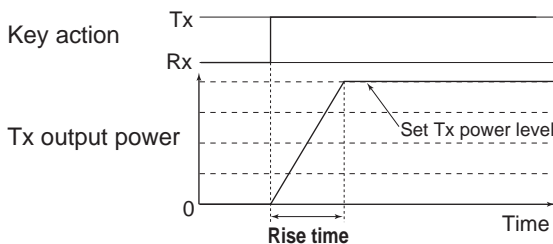

### Paddle Polarity (Default: NORMAL)

Sets the paddle polarity.

- Normal: Right – Dash, Left – Dot.
- Reverse: Right – Dot, Left – Dash.

### Keyer Type (Default: ELEC-KEY)

Selects the keyer type for the [ELEC-KEY] connector on the front panel.

- Selectable key: Straight, BUG-KEY, or ELEC-KEY.

### MIC Up/Down Keyer (Default: OFF)

Sets the microphone [UP]/[DN] switches to be used as a key. (The microphone [UP]/[DN] switches do not work as a "squeeze key.")

- ON: The [UP]/[DN] switches can be used as a key for CW.
- OFF: The [UP]/[DN] switches cannot be used as a key for CW.

**NOTE:** When "ON" is selected, the frequency and the Memory channels cannot be changed using the [UP]/[DN] switches.

## ■ Operating RTTY (FSK)

A DSP-based high-quality Baudot RTTY encoder/decoder is built-in to the transceiver. When connecting a PC keyboard, you can operate RTTY without an external RTTY terminal or PC.

If you would rather use your RTTY terminal, consult the equipment manual.

Before transmitting, monitor your selected operating frequency to make sure you don't cause interference to other stations on the same frequency.

- Connect a keyboard to the [USB A] port on the rear panel:
- The Multi-function screens are OFF:
  - ① Push a band key to select a desired band.
  - ② Push the Mode key [RTTY/PSK] to select the RTTY mode.
    - After the RTTY mode is selected, hold down [RTTY/PSK] for 1 second to toggle between the RTTY and RTTY-R modes.
    - "RTTY" or "RTTY-R" is displayed.
  - ③ Push [DECODE](F).
    - The RTTY decode screen is displayed.
  - ④ Rotate [MAIN DIAL] to tune a desired signal.
    - Aim for a symmetrical wave form, and ensure the peak points align with the mark (2125 Hz) and shift (170 Hz) frequency lines in the FFT scope.
  - ⑤ Rotate [RF PWR] to adjust the output power.
    - The TX power readout displays the setting level.
  - ⑥ Push the Multi-function [METER](▶) key to select the Po meter.
  - ⑦ Push [F12] on the keyboard to transmit.
    - The [TX] indicator lights red.
  - ⑧ Type on the keyboard to enter the contents that you want to transmit.
    - The typewritten contents are displayed in the TX buffer screen and immediately transmitted.
    - The text color will be changed when transmitted.
    - Push one of [F1]–[F8] to transmit the TX memory contents.
  - ⑨ Push [F12] on the keyboard to return to receive.

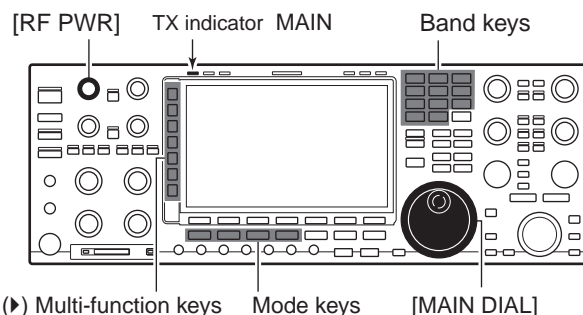

### • Waterfall display

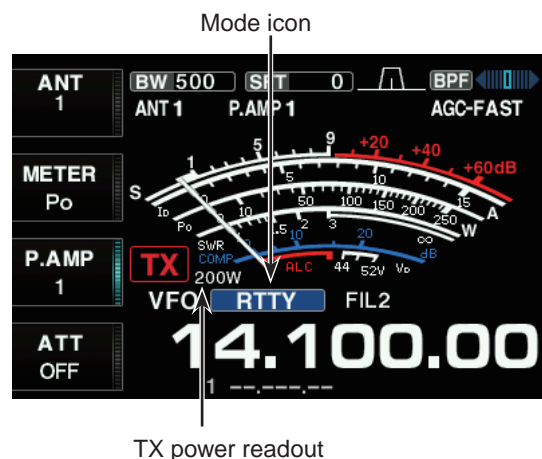
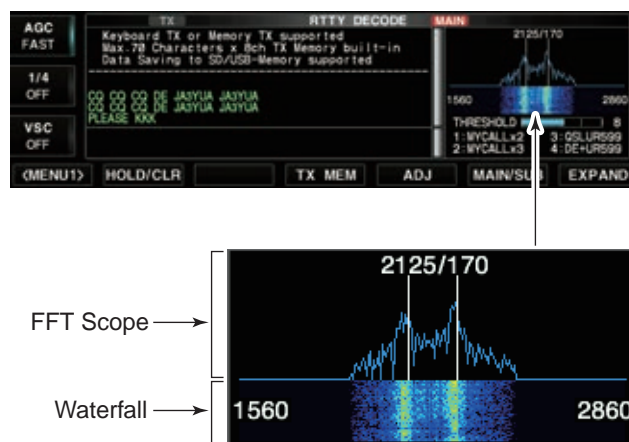

✓ **For your convenience**  
The desired text can be typed before being transmitted.

- ① Do steps ① to ④ above.
- ② Type on the keyboard to enter the message that you want to transmit.
  - The typewritten contents are displayed in the TX buffer screen.
- ③ Push [F12] on the keyboard to transmit the typewritten contents.
  - The color of displayed text in the TX buffer screen, will change when transmitted.
  - To cancel the transmission, push [F12] twice.
- ④ Push [F12] on the keyboard to return to receive.

✓ **For your convenience**  
When an external keypad is connected, the preset contents, RT1 ~ RT4 or RT5 ~ RT8, can be transmitted. See pages 3-6 and 15-16 for details.

### ◇ About the RTTY reverse mode

Received characters are occasionally garbled when the received signal has the Mark and Space tones reversed. This reversal can be caused by incorrect TNC connections, setting, or commands. To receive reversed RTTY signals correctly, select the RTTY-R mode.

- ➔ In the RTTY mode, hold down [RTTY/PSK] for 1 second to select the RTTY and RTTY-R modes.

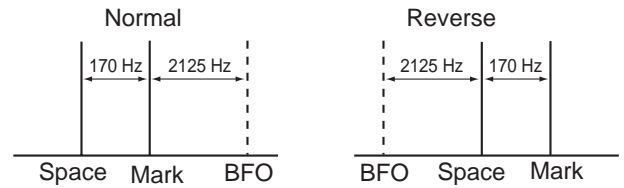

### ◇ Twin peak filter

The Twin peak filter changes the audio frequency response by boosting the mark and space frequencies (2125 and 2295 Hz) for better reception of RTTY signals.

- ➔ In the RTTY mode, push [APF/TPF] to turn the Twin peak filter ON or OFF.
  - “TPF” is displayed and the [APF/TPF] indicator above this key lights white while the filter is in use.

**NOTE:** When the Twin peak filter is used, the audio output may increase. This is a normal, not a malfunction.

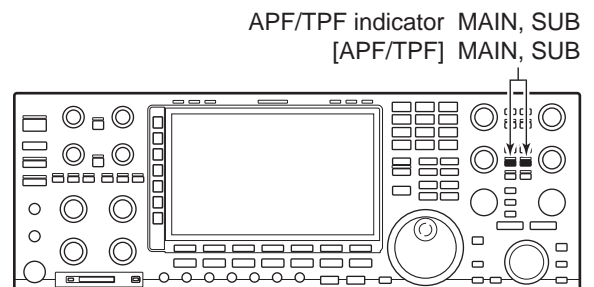

## 5 RECEIVE AND TRANSMIT

### ■ Operating RTTY (FSK) (Continued)

#### ◇ Functions for the RTTY decoder display

- ① Push the Mode key [RTTY/PSK] to select the RTTY mode.
  - After the RTTY mode is selected, hold down [RTTY/PSK] for 1 second to toggle between the RTTY and RTTY-R modes.
  - “RTTY” or “RTTY-R” appears.
- ② Push [DECODE](F).
  - The RTTY decode screen is displayed.
  - When tuned to an RTTY signal, the decoded characters are displayed in the RX contents screen.

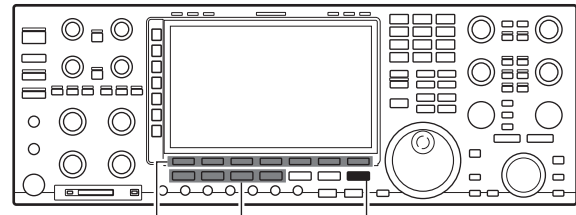

(F) Function keys    Mode keys    [EXIT/SET]

Function	Action	
<MENU1> <MENU2>	Selects the Function menu.	
HOLD/ CLR	Push	Turns ON or OFF the Hold function. • “ <b>HOLD</b> ” is displayed and the current screen freezes.
	Hold down	Clears the displayed characters. • While the Hold function is ON, clears the characters and releases the function.
TX MEM	Enters the RTTY memory screen.	
ADJ	Enters the threshold level setting mode.	
MAIN/ SUB	Toggles between the Main and Sub bands.	
LOG	Enters the RTTY log set screen. • Starts/Stop making a log file, or sets the File type or Storage media.	
LOG VIEW	Displays a log file. • You can view the log contents.	
SET	Enters the RTTY decode set screen.	
EXPAND	Toggles between the Expanded or Normal screens.	

- The Dualwatch function should be ON when the Sub band is selected (p. 7-10).
- ③ Push [EXIT/SET].
    - Exits the RTTY decode screen.

#### • RTTY decode screen (MENU1)



#### • Function menu (MENU2)

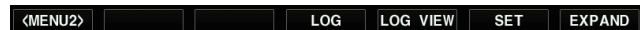

### ◇ Setting the decoder threshold level

Adjust the RTTY decoder threshold level if some characters are displayed, even though no signal is received.

- ① Display the RTTY decode screen, then push [ADJ] (F).

**DECODE [F-3] ▸ ADJ [F-5]**

- The RTTY threshold setting screen is displayed.
- ② Rotate [MAIN DIAL] to adjust the RTTY decoder threshold level.
    - Hold down [DEF](F) for 1 second to select the default setting.
  - ③ Push [EXIT/SET].
    - Exits the Setting screen.

#### • RTTY threshold setting screen



### ◇ RTTY memory transmission

Preset characters can be sent using the RTTY memory. Contents of the memory are entered in the RTTY memory edit screen.

- The Multi-function screens are OFF:

- ① Push [DECODE](F).
  - The RTTY decode screen is displayed.
- ② Push [TX MEM](F) to select the RTTY memory screen.
- ③ Push [1-4/5-8] to select the RTTY memory bank.
- ④ Push the desired function key [RT1](F) ~ [RT4](F) or [RT5](F) ~ [RT8](F).
  - When no keyboard is connected, the selected memory contents will be immediately transmitted.
  - When a keyboard is connected, the memory contents will be immediately transmitted when the function key is pushed, or transmitted after [F12] on the keyboard is pushed, depending on the Auto transmission/reception setting (see page 5-18).
  - The transmission date, time, reception date and/or time may be displayed in RX contents screen, depending on the setting.

#### ✓ For your convenience

When an external keypad is connected, the preset contents, RT1 ~ RT4 or RT5 ~ RT8, can be transmitted. See pages 3-6 and 15-16 for details.

TX indicator MAIN

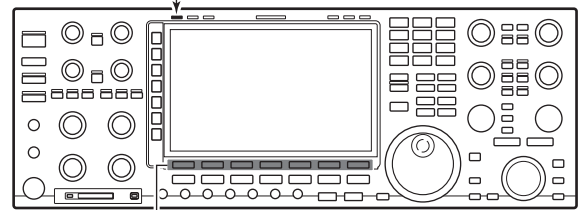

(F) Function keys

#### • RTTY memory screen (RT1-RT4)

		RTTY MEMORY		
AGC MID	RT1	MYCALLx2	„DE ICOM ICOM K„	AUTO TX/RX
1/4 OFF	RT2	MYCALLx3	„DE ICOM ICOM ICOM K„	AUTO TX/RX
VSC OFF	RT3	QSLUR599	„QSL UR 599-599 BK„	AUTO TX/RX
	RT4	DE+UR599	„QSL DE ICOM ICOM UR 599-599 BK„	AUTO TX/RX
	RT1	RT2	RT3	RT4
			EDIT	1-4/5-8

#### • RTTY memory screen (RT5-RT8)

		RTTY MEMORY		
AGC MID	RT5	73 GL SK	„73 GL SK„	AUTO TX/RX
1/4 OFF	RT6	CQ CQ CQ	„CQ CQ CQ DE ICOM ICOM ICOM K„	AUTO TX/RX
VSC OFF	RT7	RIG&ANT	„MY TRANSCEIVER IS IC-7850 & ANTENNA IS A 3-ELEMENT TRIBAND YAGI„	
	RT8	EQUIP.	„MY RTTY EQUIPMENT IS INTERNAL FSK UNIT & DEMODULATOR OF THE IC-7850„	
	RT5	RT6	RT7	RT8
			EDIT	1-4/5-8

## 5 RECEIVE AND TRANSMIT

### ■ Operating RTTY (FSK) (Continued)

#### ◇ Automatic transmission/reception setting

- ① Display the RTTY decode screen, then push [TX MEM](F).

**DECODE [F-3] ▸ TX MEM [F-4]**

- The RTTY memory screen is displayed.
- ② Push [EDIT](F).
    - The RTTY memory edit screen is displayed.
  - ③ Push [RT1..RT8](F) several times.
    - Push [RT1..RT8] to select the TX memory.  
(RT1 → RT2 → RT3 → ⋯ → RT8 → RT1)
  - ④ Push [AUTO TX](F) several times.
    - Push [AUTO TX](F) to select the Auto TX/RX setting.  
(AUTO TX/RX → AUTO TX → AUTO RX → (No indication) → AUTO TX/RX)

Selection	Action
AUTO TX/RX	Automatically transmits the selected memory and returns to receive.
AUTO TX	Automatically transmits the selected memory. To return to receive, push [F12] on the keyboard.
AUTO RX	Push [F12] on the keyboard to transmit the selected memory. Automatically returns to receive after transmission.
No indication	Push [F12] on the keyboard to transmit the selected memory and push [F12] again to return to receive.

- ⑤ Push [EXIT/SET].
  - Exits the RTTY memory edit screen.

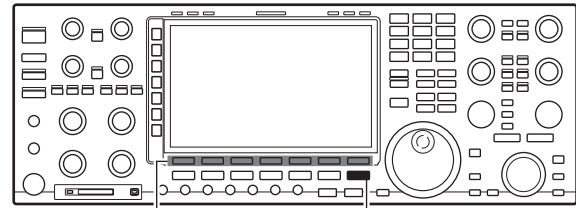

(F) Function keys

[EXIT/SET]

#### • RTTY memory edit screen



**NOTE:** When no keyboard is connected, the transceiver always functions using the “AUTO TX/RX” setting.



◇ **Editing the RTTY memory**

The contents of the RTTY memories can be set using the Memory edit menu. The memory can store and retransmit 8 RTTY message for often-used RTTY content. The capacity of the memory is 70 characters per memory channel.

• **Programming contents**

- ① Display the RTTY decode screen, then push [TX MEM](F).

**DECODE [F-3] ▸ TX MEM [F-4]**

- The RTTY memory screen is displayed.
- ② Push [EDIT](F).
    - The RTTY memory edit screen is displayed.
  - ③ Push [RT1..RT8](F) several times.
    - Push [RT1..RT8] selects the TX memory. (RT1 → RT2 → RT3 → ... → RT8 → RT1)
  - ④ Rotate [MAIN DIAL] to select the character.

Keys	Input mode/Action
[ABC](▶)	Selects the Upper case letters alphabet input mode. • Push to toggle between [abc](▶) and [ABC](▶).
[abc](▶)	Selects the Lower case letters alphabet input mode. • Selectable for only the Name item.
[123](▶)	Selects the Number input mode. • Push to toggle between [123](▶) and [Symbol](▶).
[Symbol](▶)	Selects the Symbol input mode.
[DEL](F)	Deletes a character.
[SPACE](F)	Enters a space.
[◀▶](F)	Toggles between the Name (Title) and Content items.

- When a keyboard is connected to the [USB A] port on the rear panel, you can directly enter the Names or contents using the keyboard.
  - Push keypad to enter 0 ~ 9 or a period (.).
- ⑤ Push [◀](F) or [▶](F) to move the cursor.
  - ⑥ Repeat steps ④ and ⑤ to input the desired characters or names.
  - ⑦ After editing the contents, push [EXIT/SET].
    - Exits the RTTY memory edit screen.

• **Selectable characters (with [MAIN DIAL])**

<b>ABC</b>	A B C D E F G H I J K L M N O P Q R S T U V W X Y Z
<b>abc</b>	Selectable only in the Name item: a b c d e f g h i j k l m n o p q r s t u v w x y z
<b>123</b>	1 2 3 4 5 6 7 8 9 0
<b>Symbol</b>	Name: ! # \$ % & \ ? ' ' ^ + - * / . , ; = < > ( ) [ ] { }   _ ~ @ Contents: ! \$ & ? ' ' - / . , ; ; ( ) ↵

(▶) Multi-function keys

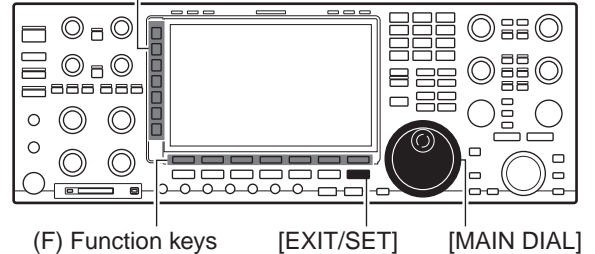

• **RTTY memory edit screen**



• **Preset contents**

CH	Name	Contents
RT1	MYCALLx2	↵DE ICOM ICOM K.↵
RT2	MYCALLx3	↵DE ICOM ICOM ICOM K.↵
RT3	QSLUR599	↵QSL UR 599-599 BK.↵
RT4	DE+UR599	↵QSL DE ICOM ICOM UR 599-599 BK.↵
RT5	73 GL SK	↵73 GL SK.↵
RT6	CQ CQ CQ	↵CQ CQ CQ DE ICOM ICOM ICOM K.↵
RT7	RIG&ANT	↵MY TRANSCEIVER IS IC-7851 & ANTENNA IS A 3-ELEMENT TRIBAND YAGI.↵
RT8	EQUIP.	↵MY RTTY EQUIPMENT IS INTERNAL FSK UNIT & DEMODULATOR OF THE IC-7851. ↵

The IC-7850 displays "IC-7850" as the model name.

## 5 RECEIVE AND TRANSMIT

### ■ Operating RTTY (FSK) (Continued)

#### ◇ Turning ON the RTTY log

Turn ON the RTTY log to store your RTTY operating record, both TX and RX, onto an SD card or USB flash drive.

Be sure to insert an SD card or USB flash drive, otherwise this function does not work.

- ① Display the RTTY decode screen, then push [**<MENU1>**](F).

**DECODE** [F-3] ▸ **<MENU1>** [F-1] ▸ *Displays <MENU2>*

- The function menu changes to Menu 2.

- ② Push [**LOG**](F).

- The RTTY log set screen is displayed.

- ③ Push [**▲**](F) or [**▼**](F) to select the desired item.

- When the “RTTY LOG” item is set to “ON,” the File type or the Storage media cannot be changed. Before starting the Log function, set these settings.

- ④ Rotate [**MAIN DIAL**] to select the desired setting.

- Set the “RTTY Log File Type” and “RTTY Log Storage Media” items.

- Hold down [**DEF**](F) for 1 second to select the default setting.

- ⑤ Select the “RTTY Log” item, and then select “ON.”

- To cancel the Log function, select “OFF.”

- ⑥ Push [**EXIT/SET**].

- Exits the Set screen.

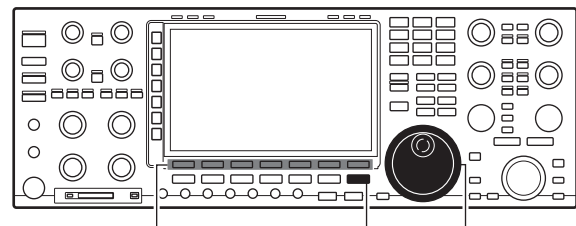

(F) Function keys

[EXIT/SET]

[MAIN DIAL]

#### • Function menu (MENU2)

[<MENU2>] [LOG] [LOG VIEW] [SET] [EXPAND]

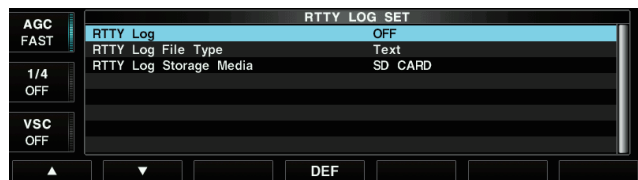

Displays after the RTTY log starts

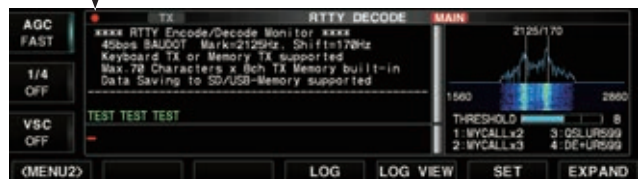

### RTTY Log (Default: OFF)

Starts or Stops making the RTTY log file.

- OFF: The RTTY log function is OFF.
- ON: The RTTY log is made onto an selected storage media. Make the log file for each transmission or reception.

### RTTY Log File Type (Default: Text)

Selects file type to make a log file onto a storage media in the Text or HTML format.

- Text: The RTTY log is saved in the Text format.
- HTML: The RTTY log is saved in the HTML format.

### RTTY Log Storage Media (Default: SD CARD)

Selects the Storage media between an SD card and USB flash drive.

### ◇ Confirm the RTTY log contents

You can confirm the RTTY log contents on the transceiver display.

- ① Display the RTTY decode screen, then push [**<MENU1>**](F).

**DECODE** [F-3] ▾ **<MENU1>** [F-1] ▾ *Displays <MENU2>*

- The function menu changes to Menu 2.

- ② Push [**LOG VIEW**](F).

- The RTTY log list screen is displayed.

- ③ Push [**▲**](F) or [**▼**](F) to select a desired file.

- “●” is displayed at left of the file name that indicates the active log making file, so the file cannot be opened.

- ④ Push [**VIEW**](F) to display the log contents.

- ⑤ After checking the log file, push [**EXIT/SET**] twice.

- Exits the RTTY log list screen.

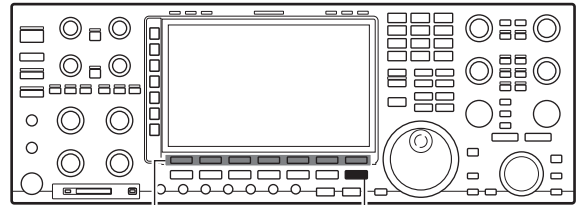

(F) Function keys

[EXIT/SET]

### • Function menu (MENU2)

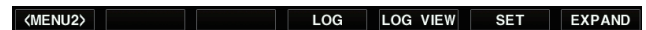

### • RTTY log list screen

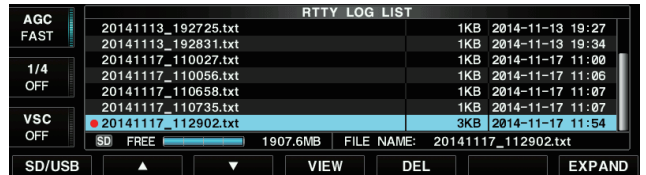

### • Functions in the RTTY log list screen

Function	Action
SD/USB	Toggles between an SD card and USB flash drive.
▲	Selects a log file.
▼	Selects a log file.
VIEW	Displays the log contents. • You can see the log contents.
DEL	Hold down for 1 second to display the dialog box for deleting.
EXPAND	Toggles between the Expanded and normal screens.

### • Example: Text format



### • Example: HTML format



## 5 RECEIVE AND TRANSMIT

### ■ Operating RTTY (FSK) (Continued)

#### ◇ RTTY decode set mode

This Set mode is used to set the decode USOS function, time stamp setting, and other RTTY settings.

- ① Display the RTTY decode screen, then push [<MENU1>](F).

**DECODE [F-3] ↘ <MENU1> [F-1] ↘ Displays <MENU2>**

- The function menu changes to Menu 2.
- ② Push [SET](F).
    - The RTTY decode set screen is displayed.
  - ③ Push [▲](F) or [▼](F) to select the desired item.
  - ④ Rotate [MAIN DIAL] to select the desired setting.
    - Hold down [DEF](F) for 1 second to select the default setting.
    - Push [◀ ▶](F) to select the set contents for some items.
  - ⑤ Push [EXIT/SET].
    - Exits the Set screen.

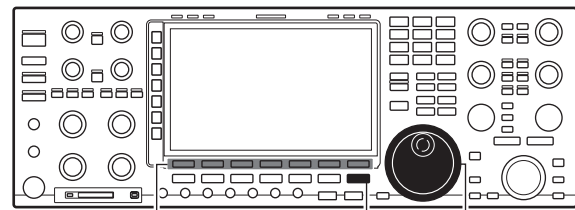

(F) Function keys [EXIT/SET] [MAIN DIAL]

#### • Function menu (MENU2)



#### • RTTY decode set screen



#### RTTY FFT Scope Averaging (Default: OFF)

Sets the FFT scope waveform averaging function from 2 to 4 or OFF.

##### **Recommendation!**

Use the default or smaller number FFT scope waveform setting for tuning.

#### RTTY FFT Scope Waveform Color (Default: (R) 51 (G) 153 (B) 255)

Sets the color of the FFT scope waveform.

- The color is set in the RGB format.
- Push [◀ ▶](F) to select R (Red), G (Green) and B (Blue). Rotate [MAIN DIAL] to adjust the ratio from 0 to 255.
- The color is displayed in the box beside the RGB scale.

#### RTTY Decode USOS (Default: ON)

Turns the letter code decoding capability ON or OFF after receiving a "space."

(USOS: UnShift On Space function)

- ON: Decodes as a letter code.
- OFF: Decodes as a character code.

#### RTTY Decode New Line Code (Default: CR,LF,CR+LF)

Selects the internal RTTY decoder new line code.

CR: Carriage Return, LF: Line Feed

- CR,LF,CR+LF: Makes new line with any codes.
- CR+LF: Makes new line with CR+LF code only.

#### RTTY Diddle (Default: BLANK)

Selects the diddle status.

- BLANK: Transmits blank code during no code transmission.
- LTRS: Transmits letter code during no code transmission.
- OFF: Turns the diddle function OFF.

#### RTTY TX USOS (Default: ON)

Explicitly inserts the FIGS character, even though it is not required by the receiving station.

- ON: Inserts FIGS.
- OFF: Does not insert FIGS.

**RTTY Auto CR+LF by TX** (Default: ON)

Selects sending a new line code (CR+LF) once when transmitting.

- ON: Transmits the CR+LF code once.
- OFF: Does not transmit the CR+LF code.

**RTTY Time Stamp** (Default: ON)

Turns the time stamp (date, transmission or reception time) display ON or OFF.

- ON: Displays the time stamp.
- OFF: Does not display the time stamp.

**RTTY Time Stamp (Time)** (Default: Local)

Selects the Clock display for the time stamp.

- Local: Selects the time that is set in "Time (Now)."
- UTC\*: Selects the time that is set in "CLOCK2."  
\*The name of the Clock 2 may differ, depending on the "CLOCK2 Name" setting (p. 14-3). "UTC" is the default name of CLOCK2.

/// **NOTE:** The time won't be displayed when "OFF" is selected in "RTTY Time Stamp" as above.

**RTTY Time Stamp (Frequency)** (Default: ON)

Selects the operating frequency display for the time stamp.

- ON: Displays the operating frequency.
- OFF: Does not display the operating frequency.

/// **NOTE:** The frequency won't be displayed when "OFF" is selected in "RTTY Time Stamp" above.

**RTTY Font Color (Receive)** (Default: (R) 128 (G) 255 (B) 128)

Sets the text color for received characters.

- The color is set in the RGB format.
- Push [◀▶](F) to select R (Red), G (Green) and B (Blue). Rotate [MAIN DIAL] to adjust the ratio from 0 to 255.
- The color is displayed in the box beside the RGB scale.

**RTTY Font Color (Transmit)** (Default: (R) 255 (G) 106 (B) 106)

Sets the text color for transmitted characters.

- The color is set in the RGB format.
- Push [◀▶](F) to select R (Red), G (Green) and B (Blue). Rotate [MAIN DIAL] to adjust the ratio from 0 to 255.
- The color is displayed in the box beside the RGB scale.

**RTTY Font Color (Time Stamp)** (Default: (R) 0 (G) 155 (B) 189)

Sets the text color for time stamp display.

- The color is set in the RGB format.
- Push [◀▶](F) to select R (Red), G (Green) and B (Blue). Rotate [MAIN DIAL] to adjust the ratio from 0 to 255.
- The color is displayed in the box beside the RGB scale.

**RTTY Font Color (TX Buffer)** (Default: (R) 255 (G) 255 (B) 255)

Sets the text color in the TX buffer screen.

- The color is set in the RGB format.
- Push [◀▶](F) to select R (Red), G (Green) and B (Blue). Rotate [MAIN DIAL] to adjust the ratio from 0 to 255.
- The color is displayed in the box beside the RGB scale.



## Operating PSK

A high-quality DSP-based PSK encoder/decoder is built into the transceiver. You can connect a keyboard to the transceiver and operate PSK without a PC. (p. 3-6)  
This transceiver can be used in the PSK31 and PSK63 modes.

If you would rather use your PSK software, consult the software manual.

Before transmitting, monitor your selected operating frequency to make sure you don't cause interference to other stations on the same frequency.

- Connect a keyboard to the [USB A] port on the rear panel:
- The Multi-function screens are OFF:
  - ① Push a band key to select a desired band.
  - ② Push the Mode key [RTTY/PSK] to select the PSK-mode.
    - After the PSK mode is selected, hold down [RTTY/PSK] for 1 second to toggle between PSK and PSK-R modes.
    - "PSK" or "PSK-R" is displayed.
  - ③ Push [DECODE](F).
    - The PSK decode screen is displayed.
  - ④ Rotate [MAIN DIAL] to tune the desired signal.
    - The signal is properly tuned when the radiated lines in the vector tuning indicator narrow, as show in the example on page 5-25.
    - The radiated lines in the vector tuning indicator may be sporadically displayed.
    - When a PSK signal is received, the waterfall display is activated.
    - The waterfall display shows the signal condition within the passband and a vertical line appears when a PSK signal is received.
- ⑤ Rotate [RF PWR] to adjust the output power.
  - The TX power readout displays the setting level.
- ⑥ Push the Multi-function [METER](▶) key to select the ALC meter.
- ⑦ Push [F12] on the keyboard to transmit.
  - The [TX] indicator lights red.
- ⑧ Rotate [DRIVE] to adjust the Drive gain.
  - Adjust the Drive gain so that the ALC meter reading swings within 30 to 50% of the ALC scale.
  - If the ALC meter reading goes outside the ALC zone, the TX distortion occurs and the readability on the receiver side may be reduced.
- ⑨ Type on the keyboard to enter the message that you want to transmit.
  - The typewritten message is displayed in the TX buffer screen and immediately transmitted.
  - The text color will change when transmitted.
  - Push one of [F1]–[F8] to transmit the TX memory contents.
- ⑩ Push [F12] on the keyboard to return to receive.

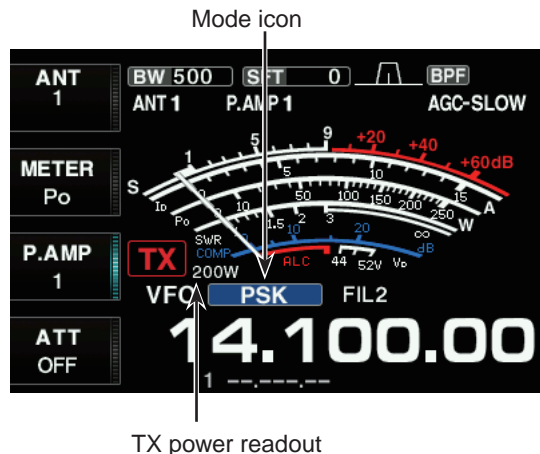
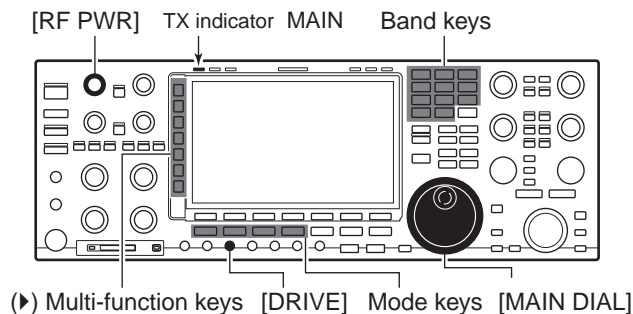

**✓ For your convenience**  
A PSK message can be typed before being transmitted.

- ① Do steps ① to ④ above and to the left.
- ② Type from the keyboard to enter the message that you want to transmit.
  - The typewritten contents are displayed in the TX buffer screen.
- ③ Push [F12] on the keyboard to transmit the typewritten contents.
  - The color of displayed text in the TX buffer screen, will change when transmitted.
  - To cancel the transmission, push [F12] twice.
- ④ Push [F12] on the keyboard to return to receive.

**✓ For your convenience**  
When an external keypad is connected, the preset contents, PT1 ~ PT4 or PT5 ~ PT8, can be transmitted. See pages 3-6 and 15-16 for details.

◇ **Vector indicator and Waterfall display**

You can fine tune the PSK signal using the Vector tuning indicator and waterfall display.

- ① Slowly rotate the [MAIN DIAL].
  - When a PSK signal is received, the vertical line appears on the waterfall display.
- ② Tune the vertical line to the Center of the waterfall display.
  - The signal is properly tuned when the radiated lines in the vector tuning indicator narrow, as shown below to the right.

• **PSK decode screen**

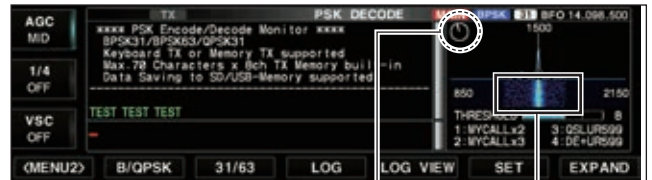

Vector tuning indicator      Waterfall

• **Vector tuning indicator**

The Vector tuning indicator is displayed when tuning the signal.

• **Indication example**

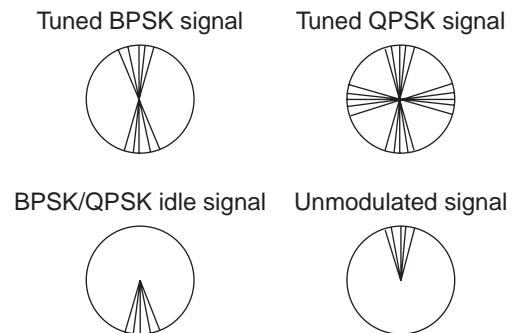

• **Waterfall display**

Displays the band activity as a waterfall. If the two or more signals are in the band, tune the displayed signal to the 1500 Hz tone.

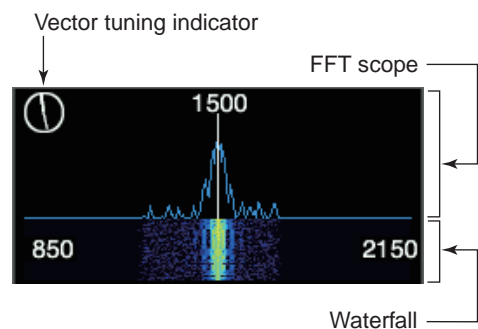



■ Operating PSK (Continued)

◇ Functions for the PSK decoder display

- ① Push the Mode key [RTTY/PSK] to select the PSK mode.
  - After the PSK mode is selected, hold down [RTTY/PSK] for 1 second to toggle between the PSK and PSK-R modes.
  - “PSK” or “PSK-R” appears.
- ② Push [DECODE](F).
  - The PSK decode screen is displayed.
  - When tuned to a PSK signal, the decoded characters are displayed in the RX contents screen.

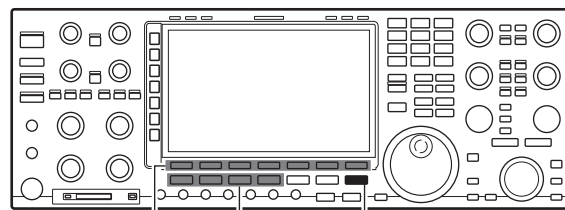

(F) Function keys    Mode keys    [EXIT/SET]

Function	Action	
<MENU1> <MENU2>	Selects the Function menu.	
HOLD/ CLR	Push	Turns ON or OFF the Hold function. • “ <b>HOLD</b> ” is displayed and the current screen freezes..
	Hold down	Clears the displayed characters. • While the Hold function is ON, clears the characters and releases the function.
AFC/NET	○ When the AFC function is OFF: Turns ON the AFC function.	
	○ When the AFC function is ON: • “ <b>AFC</b> ” is displayed. If a PSK signal is received within the AFC tuning range, the decoder automatically tunes to the signal and the frequency offset is displayed.	
	Push	Turns ON or OFF the NET function. (→ AFC/NET → OFF) • “ <b>AFC</b> ” and “ <b>NET</b> ” are displayed. You can transmit on the tuned frequency.
	Hold down	Adds the offset frequency to the operating frequency.
TX MEM	Enters the PSK memory screen.	
ADJ	Enters the threshold level setting mode.	
MAIN/ SUB	Toggles between the Main and Sub bands.	
B/QPSK	Toggles between the BPSK and QPSK modes.	
31/63	Toggles between the BPSK31 and BPSK63 modes.	
LOG	Enters the PSK log set screen. • Starts/Stops making a log file, or sets the File type or Storage media.	
LOG VIEW	Displays a log file. • You can view the log contents.	
SET	Enters the PSK decode set screen.	
EXPAND	Toggles between the Expanded and Normal screens.	

• PSK decode screen (MENU1)



• Function menu (MENU2)



• The Dualwatch function should be ON when the Sub band is selected (p. 7-10).

- ③ Push [EXIT/SET].
  - Exits the PSK decode screen.

◇ About the BPSK and QPSK modes

The BPSK and QPSK modes are selectable in the PSK31 mode.

- The BPSK (Binary Phase Shift Keying) mode is the most commonly used mode.
- The QPSK (Quadrature Phase Shift Keying) mode has error correction capability to provide better decoding than the BPSK mode in marginal conditions. However, more accurate tuning is required with the QPSK mode, due to the tight phase margin of QPSK.

① Display the PSK decode screen, then push [**<MENU1>**](F).

**DECODE** [F-3] ▾ **<MENU1>** [F-1] ▾ *Displays <MENU2>*

- The function menu changes to Menu 2.

② Push [**B/QPSK**](F).

- Toggles between the BPSK and QPSK modes.

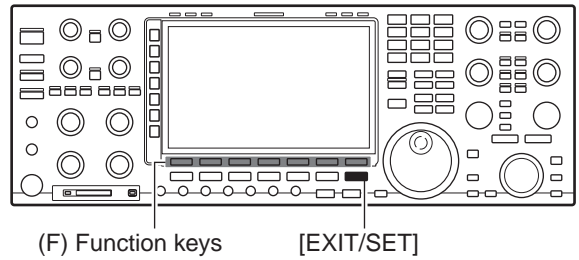

• PSK decode screen (MENU2)

“**BPSK**” or “**QPSK**” is displayed

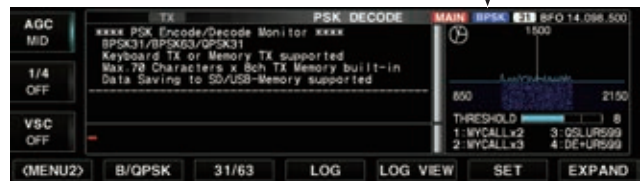

◇ About the BPSK31 and BPSK63 modes

The BPSK31 and BPSK63 modes are selectable for the BPSK mode.

① Display the PSK decode screen, then push [**<MENU1>**](F).

**DECODE** [F-3] ▾ **<MENU1>** [F-1] ▾ *Displays <MENU2>*

- The function menu changes to Menu 2.

② Push [**31/63**](F).

- Toggles between the BPSK31 and BPSK63 modes.
- When the QPSK mode is selected, the BPSK63 mode cannot be selected.

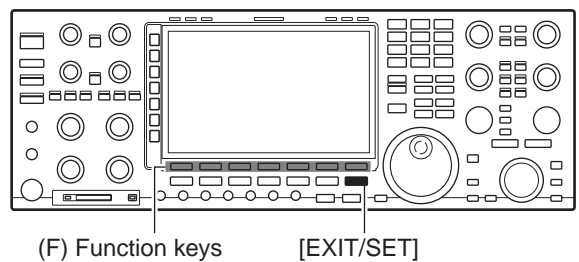

• PSK decode screen (MENU2)

“**31**” or “**63**” is displayed

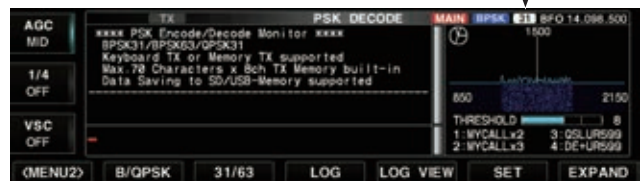

## 5 RECEIVE AND TRANSMIT

### ■ Operating PSK (Continued)

#### ◇ Setting the decoder threshold level

Adjust the PSK decoder threshold level if some characters are displayed even, though no signal is received.

- ① Display the PSK decode screen, then push [ADJ](F).  
**DECODE [F-3] ▸ ADJ [F-5]**
  - The threshold setting screen is displayed.
- ② Rotate [MAIN DIAL] to adjust the PSK decoder threshold level.
  - Hold down [DEF](F) for 1 second to select the default setting.
- ③ Push [EXIT/SET].
  - Exits the Setting screen.

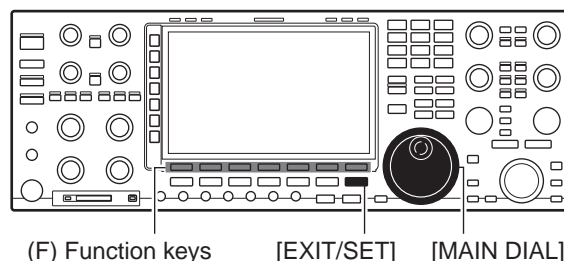

#### ◇ About the PSK reverse mode

If the received signal is not properly demodulated, try selecting the PSK-R mode.

In the QPSK mode, the phase shift direction must be the same on the transmitter and the receiver sides. To receive the reverse direction signal, select the PSK-R mode to match the phase shift direction to the transmitter side.

- In the PSK mode, hold down [RTTY/PSK] for 1 second to select the PSK and PSK-R modes.

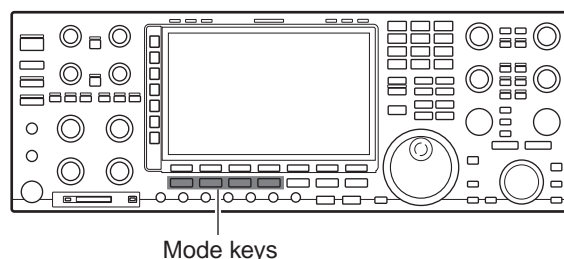

#### ◇ AFC/NET functions

This transceiver has an AFC (Auto Frequency Control) function. This is convenient to tune the PSK signal. This transceiver also has a NET function that transmits the PSK signal tuned by the AFC function.

- In the PSK decode screen, push [AFC/NET](F).
  - Push [AFC/NET](F) selects these functions.
    - “AFC” (AFC ON) → “AFC” and “NET” (AFC/NET ON) → (The icons disappear) → “AFC” (AFC ON) . . . .
  - When “AFC” or “AFC” and “NET” are displayed, displays the frequency offset between the operating frequency and the PSK signal.
  - The AFC tuning range is set to ±15 Hz by default. You can select a ±8 Hz setting in the PSK decode set mode. (p. 5-34)
- When the frequency offset is displayed, hold down [AFC/NET](F) for 1 second to add the frequency offset to the operating frequency.

**NOTE:** The AFC function may not tune the signal properly when a weak PSK signal is received.

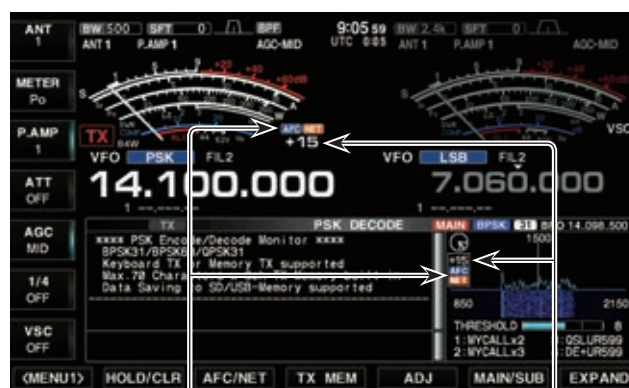

### ◇ PSK memory transmission

Preset characters can be sent using the PSK memory. Contents of the memory are entered in the PSK memory edit screen.

○ The Multi-function screens are OFF:

- ① Push [DECODE](F).
  - The PSK decode screen is displayed.
- ② Push [TX MEM](F) to select the PSK memory screen.
- ③ Push [1-4/5-8] to select the PSK memory bank.
- ④ Push the desired function key [PT1](F) ~ [PT4](F) or [PT5](F) ~ [PT8](F).
  - When no keyboard is connected, the selected memory contents will be immediately transmitted.
  - When a keyboard is connected, the memory contents will be immediately transmitted when the function key is pushed, or transmitted after [F12] on the keyboard is pushed, depending on the Auto transmission/reception setting (see page 5-30).
  - The transmission date, time, reception date and/or time may be displayed in RX contents screen, depending on the setting.

#### ✓ For your convenience

When an external keypad is connected, the preset contents, PT1 ~ PT4 or PT5 ~ PT8, can be transmitted. See pages 3-6 and 15-16 for details.

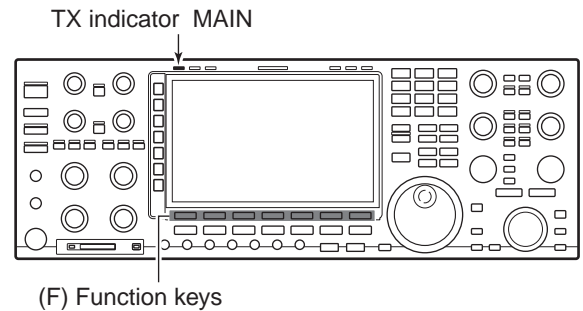

#### • PSK memory screen (PT1-PT4)

		PSK MEMORY		
AGC MID	PT1	MYCALLx2	„DE lcom lcom K,„	AUTO TX/RX
1/4 OFF	PT2	MYCALLx3	„DE lcom lcom lcom K,„	AUTO TX/RX
VSC OFF	PT3	QSLUR599	„QSL UR 599 599 BK,„	AUTO TX/RX
	PT4	DE+UR599	„QSL DE lcom lcom UR 599 599 BK,„	AUTO TX/RX
	PT1	PT2	PT3	PT4
			EDIT	1-4/5-8

#### • PSK memory screen (PT5-PT8)

		PSK MEMORY		
AGC MID	PT5	73 GL SK	„73 GL SK,„	AUTO TX/RX
1/4 OFF	PT6	CQ CQ CQ	„CQ CQ CQ DE lcom lcom lcom K,„	AUTO TX/RX
VSC OFF	PT7	RIG&ANT	„My transceiver is IC-7850 & Antenna is a 3-element triband yagi,„	
	PT8	EQUIP.	„My PSK equipment is internal modulator & demodulator of the IC-7850,„	
	PT5	PT6	PT7	PT8
			EDIT	1-4/5-8

## 5 RECEIVE AND TRANSMIT

### ■ Operating PSK (Continued)

#### ◇ Automatic transmission/reception setting

- ① Display the PSK decode screen, then push [TX MEM](F).

**DECODE [F-3] ▾ TX MEM [F-4]**

- The PSK memory screen is displayed.
- ② Push [EDIT](F).
    - The PSK memory edit screen is displayed.
  - ③ Push [PT1..PT8](F) several times.
    - Push [PT1..PT8] to select the TX memory. (PT1 → PT2 → PT3 → ... → PT8 → PT1)
  - ④ Push [AUTO TX](F) several times.
    - Push [AUTO TX](F) to select the Auto TX/RX setting. (AUTO TX/RX → AUTO TX → AUTO RX → (No indication) → AUTO TX/RX)

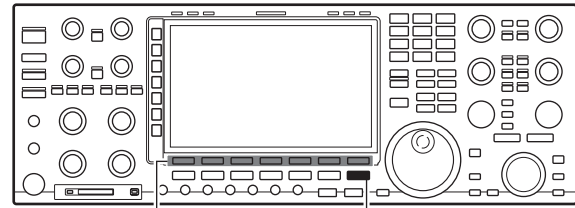

(F) Function keys [EXIT/SET]

Selection	Action
AUTO TX/RX	Automatically transmits the selected memory and returns to receive.
AUTO TX	Automatically transmits the selected memory. To return to receive, push [F12] on the keyboard.
AUTO RX	Push [F12] on the keyboard to transmit the selected memory. Automatically returns to receive after transmission.
No indication	Push [F12] on the keyboard to transmit the selected memory and push [F12] again to return to receive.

- ⑤ Push [EXIT/SET].
  - Exits the PSK memory edit screen.

#### • PSK memory edit screen



**NOTE:** When no keyboard is connected, the transceiver always functions using the “AUTO TX/RX” setting.

### ◇ Editing the PSK memory

The contents of the PSK memories can be set using the Memory edit menu. The memory can store and retransmit 8 PSK message for often-used PSK content. Total capacity of the memory is 70 characters per memory channel.

#### • Programming contents

- ① Display the PSK decode screen, then push [TX MEM](F).

**DECODE [F-3] ▸ TX MEM [F-4]**

- The PSK memory screen is displayed.
- ② Push [EDIT](F).
    - The PSK memory edit screen is displayed.
  - ③ Push [PT1..PT8](F) several times.
    - Push [PT1..PT8] selects the TX memory. (PT1 → PT2 → PT3 → ... → PT8 → PT1)
  - ④ Rotate [MAIN DIAL] to select the character.

Keys	Input mode/Action
[ABC](▶)	Selects the Upper case letters alphabet input mode. • Push to toggle between [abc](▶) and [ABC](▶).
[abc](▶)	Selects the Lower case letters alphabet input mode.
[123](▶)	Selects the Number input mode. • Push to toggle between [123](▶) and [Symbol](▶).
[Symbol](▶)	Selects the Symbol input mode.
[DEL](F)	Deletes a character.
[SPACE](F)	Enters a space.
[◀▶](F)	Toggles between the Name (Title) and Content items.

- When a keyboard is connected to the [USB A] port on the rear panel, you can directly enter the Name or contents using the keyboard.
  - Push keypad to enter 0 ~ 9 or a period (.).
- ⑤ Push [◀](F) or [▶](F) to move the cursor.
  - ⑥ Repeat steps ④ and ⑤ to input the desired characters or names.
  - ⑦ After editing the contents, push [EXIT/SET].
    - Exits the PSK memory edit screen.

#### • Selectable characters (with [MAIN DIAL])

<b>ABC</b>	A B C D E F G H I J K L M N O P Q R S T U V W X Y Z
<b>abc</b>	a b c d e f g h i j k l m n o p q r s t u v w x y z
<b>123</b>	1 2 3 4 5 6 7 8 9 0
<b>Symbol</b>	! # \$ % & \ ? " ' ` ^ + - * / . , ; = < > ( ) [ ] { }   _ ~ @ ◀ “◀” is selectable only in the contents item.

#### ▶ Multi-function keys

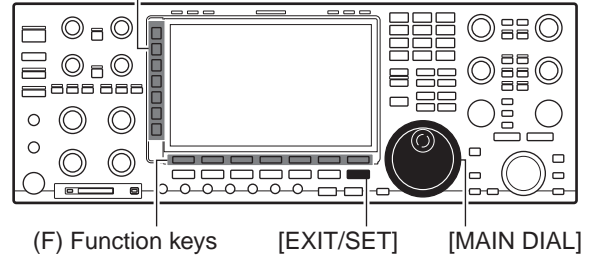

#### • PSK memory edit screen



#### • Preset contents

CH	Name	Contents
PT1	MYCALLx2	◀DE Icom Icom K.◀
PT2	MYCALLx3	◀DE Icom Icom Icom K.◀
PT3	QSLUR599	◀QSL UR 599 599 BK.◀
PT4	DE+UR599	◀QSL DE Icom Icom UR 599 599 BK.◀
PT5	73 GL SK	◀73 GL SK.◀
PT6	CQ CQ CQ	◀CQ CQ CQ DE Icom Icom Icom K.◀
PT7	RIG&ANT	◀My transceiver is IC-7851 & Antenna is a 3-element triband yagi.◀
PT8	EQUIP.	◀My PSK equipment is internal modulator & demodulator of the IC-7851.◀

The IC-7850 displays “IC-7850” as the model name.



## 5 RECEIVE AND TRANSMIT

### ■ Operating PSK (Continued)

#### ◇ Turning ON the PSK log

Turn ON the PSK log to store your PSK operating record, both TX and RX, onto an SD card or USB flash drive.

Be sure to insert an SD card or USB flash drive, otherwise this function does not work.

- ① Display the PSK decode screen, then push [<MENU1>](F).

**DECODE** [F-3] ↘ [<MENU1>] [F-1] ↘ *Displays <MENU2>*

- The function menu changes to Menu 2.

- ② Push [LOG](F).

- The PSK log set screen is displayed.

- ③ Push [▲](F) or [▼](F) to select the desired item.

- When the “PSK LOG” item is set to “ON,” the File type or the Storage media cannot be changed. Before starting the Log function, set these settings.

- ④ Rotate [MAIN DIAL] to select the desired setting.

- Set the “PSK Log File Type” and “PSK Log Storage Media” items.
- Hold down [DEF](F) for 1 second to select the default setting.

- ⑤ Select the “PSK Log” item, and then select “ON.”

- To cancel the Log function, select “OFF.”

- ⑥ Push [EXIT/SET].

- Exits the Set screen.

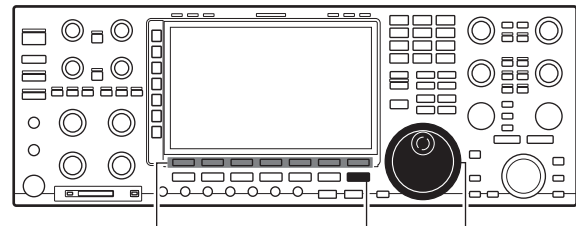

(F) Function keys

[EXIT/SET]

[MAIN DIAL]

#### • Function menu (MENU2)

<MENU2> B/QPSK 31/63 LOG LOG VIEW SET EXPAND



Displays after the PSK log starts



#### PSK Log (Default: OFF)

Starts or Stops making the PSK log file.

- OFF: The PSK log function is OFF.
- ON: The PSK log is made onto an selected storage media. Make the log file for each transmission or reception.

#### PSK Log File Type (Default: Text)

Selects file type to make a log file onto a storage media in the Text or HTML format.

- Text: The PSK log is saved in the Text format.
- HTML: The PSK log is saved in the HTML format.

#### PSK Log Storage Media (Default: SD CARD)

Selects the Storage media between an SD card and USB flash drive.



### ◇ Confirm the PSK log contents

You can confirm the PSK log contents on the transceiver display.

- Display the PSK decode screen, then push [<MENU1>](F).

**DECODE [F-3] ▾ <MENU1> [F-1] ▾ Displays <MENU2>**

- The function menu changes to Menu 2.

- Push [LOG VIEW](F).

- The PSK log list screen is displayed.

- Push [▲](F) or [▼](F) to select a desired file.

- “●” is displayed at left of the file name that indicates the active making log file, so the file cannot be opened.

- Push [VIEW](F) to display the log.

- After checking the log file, push [EXIT/SET] twice.

- Exits the PSK log list screen.

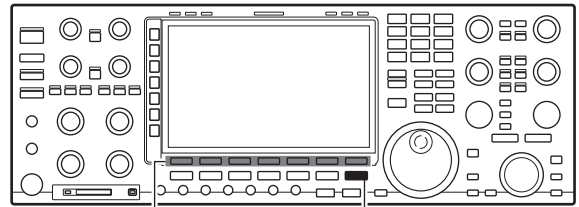

(F) Function keys

[EXIT/SET]

### • Function menu (MENU2)

<MENU2> B/QPSK 31/63 LOG LOG VIEW SET EXPAND

### • PSK log list screen

PSK LOG LIST	
AGC MID	20141117_194157.txt 1KB 2014-11-17 19:43
	20141117_194421.htm 1KB 2014-11-17 19:48
	20141118_102657.htm 1KB 2014-11-18 10:26
	20141118_105824.htm 1KB 2014-11-18 10:58
	● 20141118_110744.htm 1KB 2014-11-18 11:07
1/4 OFF	
VSC OFF	
SD/USB	SD FREE 1909.7MB FILE NAME: 20141118_110744.htm
	▲ ▼ VIEW DEL EXPAND

### • Functions in the PSK log list screen

Function	Action
SD/USB	Toggles between an SD card or USB flash drive.
▲	Select a log file.
▼	
VIEW	Displays the log contents. • You can see the log contents.
DEL	Hold down for 1 second to display the dialog box for deleting.
EXPAND	Toggles between the Expanded and normal screens.

### • Example: Text format

PSK LOG VIEWER	
AGC MID	<RX 14.091.188 20141117 19:41:57>
	TEST TEST TEST
	DE JA3YUA JA3YUA
1/4 OFF	TEST 12345
	TEST 12345
VSC OFF	THE QUICK BROWN FOXES JUMPED OVER THE LAZY DOGS.
	DE JA3YUA
	OVER.
	▲ ▼ EXPAND

### • Example: HTML format

PSK LOG VIEWER	
AGC MID	<TX 14.091.582 20141117 19:44:21>
	DE JA3YUA
1/4 OFF	<RX 14.091.582 20141117 19:44:25>
	TEST TEST TEST
	DE JA3YUA JA3YUA
VSC OFF	TEST 12345
	THE QUICK BROWN FOXES JUMPED OVER THE LAZY DOGS.
	DE JA3YUA
	▲ ▼ EXPAND

## 5 RECEIVE AND TRANSMIT

### ■ Operating PSK (Continued)

#### ◇ PSK decode set mode

This Set mode is used to set the FFT scope setting, time stamp setting, and so on.

- ① Display the PSK decode screen, then push [**<MENU1>**](F).

**DECODE** [F-3] ↘ **<MENU1>** [F-1] ↘ *Displays <MENU2>*

- The function menu changes to Menu 2.
- ② Push [**SET**](F).
    - The PSK decoder set screen is displayed.
  - ③ Push [**▲**](F) or [**▼**](F) to select the desired item.
  - ④ Rotate [**MAIN DIAL**] to select the desired setting.
    - Hold down [**DEF**](F) for 1 second to select the default setting.
    - Push [**◀ ▶**](F) to select the set contents for some items.
  - ⑤ Push [**EXIT/SET**].
    - Exits the Set screen.

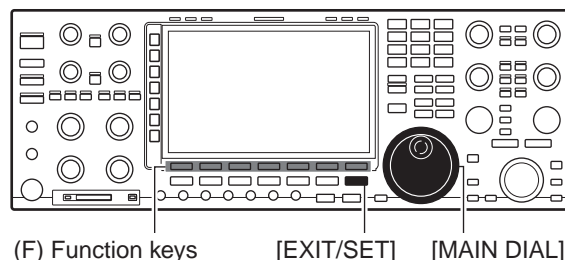

#### • PSK decode set screen

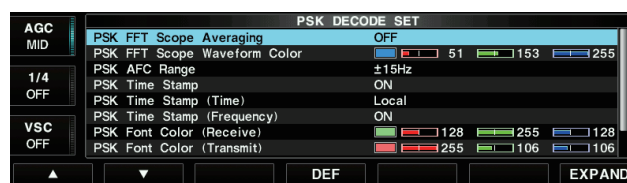

#### PSK FFT Scope Averaging (Default: OFF)

Sets the FFT scope waveform averaging function from 2 to 4 or OFF.

##### **Recommendation!**

Use the default or smaller number FFT scope waveform setting for tuning.

#### PSK FFT Scope Waveform Color (Default: (R) 51 (G) 153 (B) 255)

Sets the color of the FFT scope waveform.

- The color is set in the RGB format.
- Push [**◀ ▶**](F) to select R (Red), G (Green) and B (Blue). Rotate [**MAIN DIAL**] to adjust the ratio from 0 to 255.
- The color is displayed in the box beside the RGB scale.

#### PSK AFC Range (Default: ±15 Hz)

Selects the AFC (Automatic Frequency Control) function operating range between ±15 Hz (default) and ±8 Hz.

⚡ **NOTE:** The AFC function may not tune the signal properly when a weak PSK signal is received.

#### PSK Time Stamp (Default: ON)

Turns the time stamp (date, transmission or reception time) display ON or OFF.

- ON: Displays the time stamp.
- OFF: Does not display the time stamp.

#### PSK Time Stamp (Time) (Default: Local)

Selects the Clock display for the time stamp.

- Local: Selects the time that is set in "Time (Now)."
  - UTC\*: Selects the time that is set in "CLOCK2."
- \*The name of Clock 2 may differ, depending on the "CLOCK2 Name" setting (p. 14-3). "UTC" is the default name of CLOCK2.

⚡ **NOTE:** The time won't be displayed when "OFF" is selected in "PSK Time Stamp" above.

#### PSK Time Stamp (Frequency) (Default: ON)

Selects the operating frequency display for the time stamp.

- ON: Displays the operating frequency.
- OFF: Does not display the operating frequency.

⚡ **NOTE:** The frequency won't be displayed when "OFF" is selected in "PSK Time Stamp" above

**PSK Font Color (Receive)**

(Default: (R) 128 (G) 255 (B) 128)

Sets the text color for received characters.

- The color is set in the RGB format.
- Push [◀ ▶](F) to select R (Red), G (Green) and B (Blue). Rotate [MAIN DIAL] to adjust the ratio from 0 to 255.
- The color is displayed in the box beside the RGB scale.

**PSK Font Color (Transmit)**

(Default: (R) 255 (G) 106 (B) 106)

Sets the text color for transmitted characters.

- The color is set in the RGB format.
- Push [◀ ▶](F) to select R (Red), G (Green) and B (Blue). Rotate [MAIN DIAL] to adjust the ratio from 0 to 255.
- The color is displayed in the box beside the RGB scale.

**PSK Font Color (Time Stamp)**

(Default: (R) 0 (G) 155 (B) 189)

Sets the text color for time stamp display.

- The color is set in the RGB format.
- Push [◀ ▶](F) to select R (Red), G (Green) and B (Blue). Rotate [MAIN DIAL] to adjust the ratio from 0 to 255.
- The color is displayed in the box beside the RGB scale.

**PSK Font Color (TX Buffer)**

(Default: (R) 255 (G) 255 (B) 255)

Sets the text color in the TX buffer screen.

- The color is set in the RGB format.
- Push [◀ ▶](F) to select R (Red), G (Green) and B (Blue). Rotate [MAIN DIAL] to adjust the ratio from 0 to 255.
- The color is displayed in the box beside the RGB scale.

## ■ Operating AM or FM

Before transmitting, monitor the operating frequency to make sure transmitting won't cause interference to other stations on the same frequency.

- ① Push a band key to select the desired band.
- ② Push the Mode key [AM/FM] to select the AM or FM mode.
  - "AM" or "FM" is displayed.
- ③ Rotate [AF] to set the audio to a comfortable listening level.
- ④ Rotate [MAIN DIAL] to tune a desired signal.
  - The tuning step is set to 1 kHz for AM, and 10 kHz for FM by default. You can change it in the TS screen. (p. 4-7)
- ⑤ Rotate [RF PWR] to adjust the output power.
  - The TX power readout displays the setting level.
- ⑥ Push the Multi-function [METER](▶) key to select the Po meter.
- ⑦ Transmit.
  - Push [TRANSMIT] or [PTT] (microphone).
  - The [TX] indicator lights red.
- ⑧ Rotate [MIC] to adjust the Microphone gain.
  - While speaking into the microphone at your normal voice level, adjust the microphone gain. Check the audio clarity with another station listening to your voice, or using the Monitor function (p. 8-5).
- ⑨ After your transmission is finished, returns to receive.
  - Push [TRANSMIT] or release [PTT].

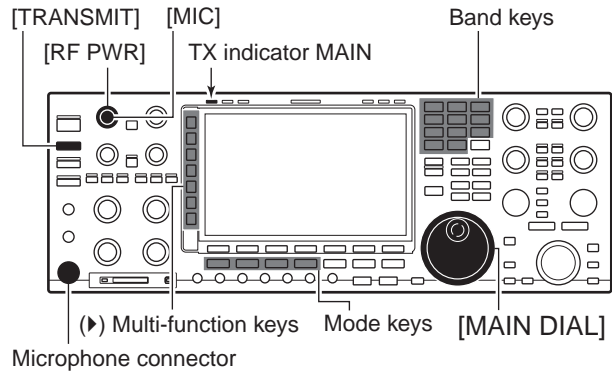

TX power readout

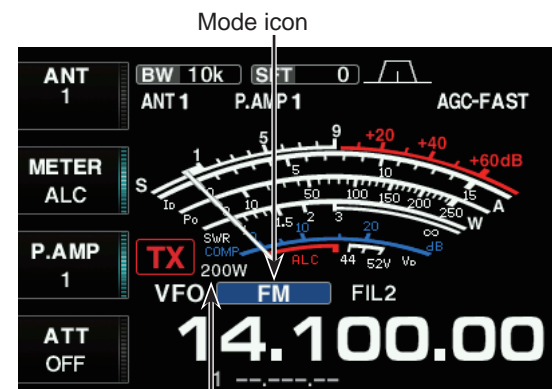

TX power readout

**For your reference:**  
 FM narrow transmission can be used when "FIL2" or "FIL3" is selected.

## ■ Repeater operation

A repeater amplifies received signals and retransmits them on a different frequency. When using a repeater, the transmit frequency is shifted from the receive frequency by an offset amount. A repeater can be accessed using split frequency operation with the shift frequency set to the repeater's frequency offset.

▨ To access a repeater that requires a repeater tone, set the repeater tone frequency in the Tone frequency screen. (p. 5-38)

- ① Push a band key to select a desired band.
- ② Push the Mode key [AM/FM] to select the FM mode.
  - "FM" is displayed.
- ③ Rotate [MAIN DIAL] to tune a desired signal.
- ④ Hold down [SPLIT] for 1 second to start repeater operation.
  - The repeater tone is automatically turned ON.
  - "SPLIT" is displayed and the [SPLIT] indicator lights.
  - The shifted transmit frequency, "TONE" and "TX" appear in the Sub band.
  - You can independently set the frequency offset for the HF band and the 50 MHz band (p. 15-14). You can also set the Repeater tone frequency (p 5-38).
- ⑤ Operate in the normal way.

▨ While using the Split function, transmission is made on the Sub band, and the reception is made on the Main band.

### ◇ Checking the repeater input signal

You can check whether another station's transmit signal can be received directly or not, by listening to the repeater input frequency.

- ➡ While receiving, hold down [XFC] to listen on the repeater input frequency.

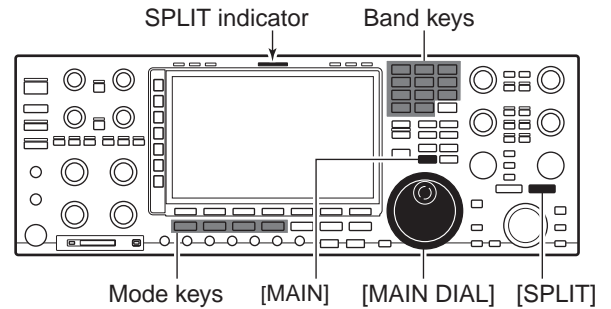

### • Repeater operation screen

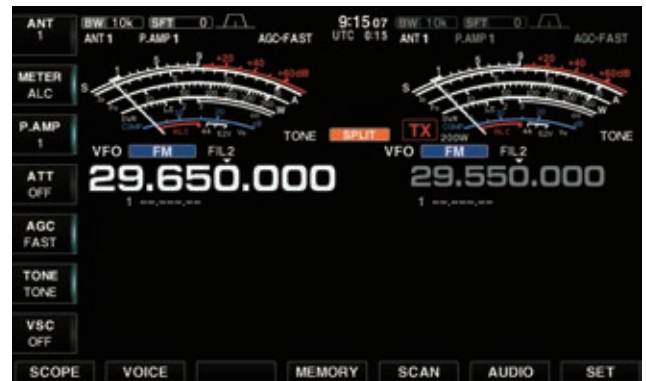

### • While holding down [XFC]

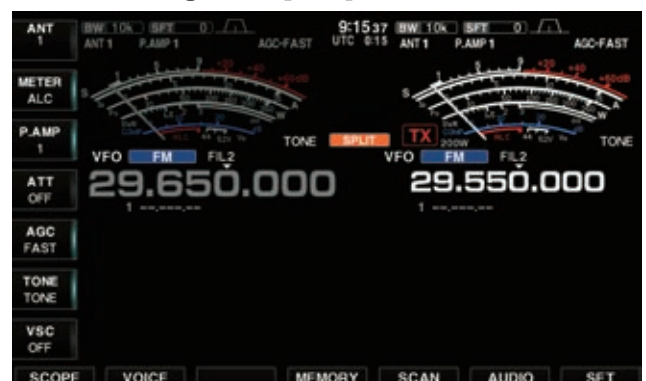

## 5 RECEIVE AND TRANSMIT

### ■ Repeater operation (Continued)

#### ◇ Repeater tone frequency setting

Some repeaters require subaudible tones to be accessed. Subaudible tones are superimposed on your normal signal, and must be set in advance. The transceiver has 50 tones from 67.0 Hz to 254.1 Hz.

- ① Hold down the Multi-function [TONE](▶) key for 1 second.
  - The Tone frequency screen is displayed.
- ② Push [▲](F) or [▼](F) to select the "REPEATER TONE" item.
- ③ Rotate [MAIN DIAL] to select the desired repeater tone frequency.
  - The selectable tone frequencies are listed below.
  - Hold down [DEF](F) for 1 second to select the default setting.
  - Pushing [T-SCAN](F) toggles the Tone Scan function ON or OFF. (p. 12-10)
- ④ Push the Multi-function [TONE](▶) key.
  - Exits the Tone frequency screen.

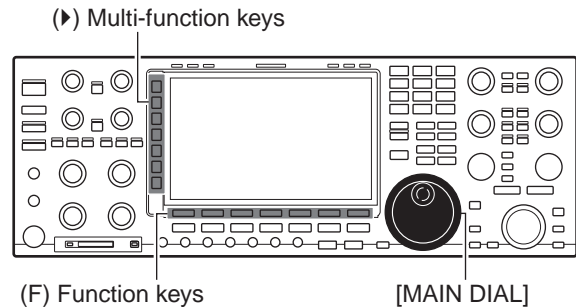

#### • Tone frequency screen



#### • Selectable tone frequencies (unit: Hz)

67.0	85.4	107.2	136.5	165.5	186.2	210.7	254.1
69.3	88.5	110.9	141.3	167.9	189.9	218.1	
71.9	91.5	114.8	146.2	171.3	192.8	225.7	
74.4	94.8	118.8	151.4	173.8	196.6	229.1	
77.0	97.4	123.0	156.7	177.3	199.5	233.6	
79.7	100.0	127.3	159.8	179.9	203.5	241.8	
82.5	103.5	131.8	162.2	183.5	206.5	250.3	

## ■ Tone squelch operation

The tone squelch opens only when you receive a signal containing a matching subaudible tone in the FM mode.

You can silently wait for calls from others using the same tone.

When you transmit, the tone frequency is superimposed on your own signal.

- ① Push a band key to select a desired band.
- ② Push the Mode key [AM/FM] to select the FM mode.
  - “FM” is displayed.
- ③ Push the Multi-function [TONE](▶) key to turn ON the Tone Squelch function.
  - “TSQL” is displayed.
  - Pushing the Multi-function [TONE](▶) key toggles the tone setting between “TONE,” “TSQL,” and OFF.
- ④ Hold down the Multi-function [TONE](▶) key for 1 second.
  - The Tone frequency screen is displayed.
- ⑤ Push [▲](F) or [▼](F) to select the “T-SQL TONE” item.
- ⑥ Rotate [MAIN DIAL] to select the desired tone squelch frequency.
  - The selectable tone frequencies are listed below.
  - Hold down [DEF](F) for 1 second to select the default setting.
  - Pushing [T-SCAN](F) toggles the Tone Scan function ON and OFF. (p. 12-10)
- ⑦ Push the Multi-function [TONE](▶) key.
  - Exits the Tone frequency screen.
  - When the received signal includes a matching tone, squelch opens and the signal can be heard.
- ⑧ Operate in the normal way.
  - When you transmit, the tone frequency is superimposed on your signal.

(▶) Multi-function keys

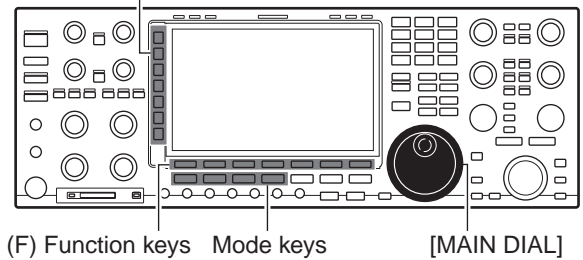

### • Tone squelch function ON



### • Tone frequency screen



### • Selectable tone frequencies (unit: Hz)

67.0	85.4	107.2	136.5	165.5	186.2	210.7	254.1
69.3	88.5	110.9	141.3	167.9	189.9	218.1	
71.9	91.5	114.8	146.2	171.3	192.8	225.7	
74.4	94.8	118.8	151.4	173.8	196.6	229.1	
77.0	97.4	123.0	156.7	177.3	199.5	233.6	
79.7	100.0	127.3	159.8	179.9	203.5	241.8	
82.5	103.5	131.8	162.2	183.5	206.5	250.3	



## ■ Data mode (AFSK) operation

When operating AMTOR or PACKET with a PC application software, consult the manual that comes with the software.

Before transmitting, monitor the operating frequency to make sure transmitting won't cause interference to other stations on the same frequency.

- Connect a PC or other device to the transceiver. (p. 3-8)
- ① Push a band key to select a desired band.
- ② Push the Mode key [SSB] or [AM/FM] to select the desired mode.
  - Normally, the LSB mode is used in the HF band, and the FM mode is used in the VHF band.
- ③ Push [DATA] to turn ON the data mode.
  - In the data mode, hold down [DATA] for 1 second to sequentially toggle the data mode between D1, D2, and D3.
  - Push [DATA] again to turn OFF the data mode.
- ④ Rotate [MAIN DIAL] to tune in the desired signal and decoded correctly.
  - Also use the tuning indicator of the PC software.
  - In the SSB data mode, 1/4 tuning function can be used for critical tuning.
- ⑤ Push the Multi-function [METER](▶) key to select the Po meter.
- ⑥ Rotate [RF PWR] to adjust the output power.
  - The TX power readout displays the setting level.
- ⑦ Transmit by using the PC (software).
  - The [TX] indicator lights red.
  - When operating in the SSB data mode, adjust the PC's output level so that the ALC meter reading doesn't go outside the ALC zone.
- ⑧ Transmit the AFSK signal by using the keyboard.
  - After your transmission is finished, returns to receive.

### ✓ For your information

The carrier frequency is displayed when the SSB data mode is selected.

See the diagram to the right for a tone-pair example.

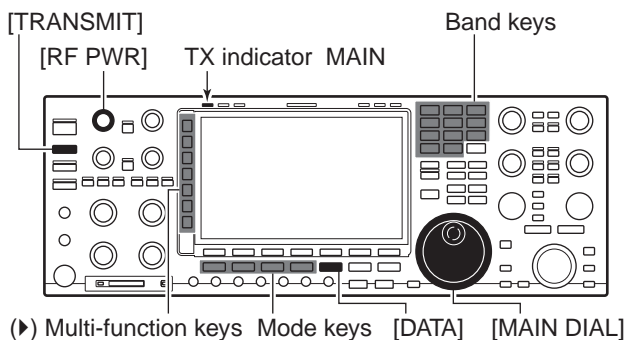

**NOTE:** When the SSB data mode is selected, the audio input from [ACC 1] is used for modulation input instead of [MIC].  
The following settings are used for SSB data transmission.

- [COMP]: OFF
- Tx Tone (Bass): 0
- Tx Tone (Trebles): 0

### • 2125 Hz/2295 Hz tone-pair in the LSB mode

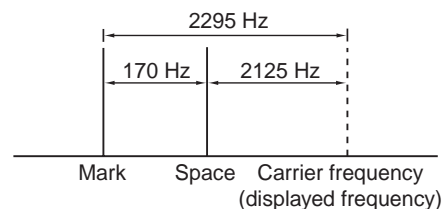

---

■ Spectrum scope screen .....	6-2
◇ Operating the Spectrum scope .....	6-3
◇ Center mode .....	6-4
◇ Fixed mode .....	6-5
◇ Dual scope screen .....	6-6
◇ Mini scope screen .....	6-6
◇ Scope attenuator .....	6-7
◇ Adjusting the Reference level .....	6-8
◇ Sweep speed .....	6-9
◇ Scope set screen .....	6-10
◇ USB mouse operation .....	6-14
■ Audio scope screen .....	6-15
◇ Audio scope set mode .....	6-16

## ■ Spectrum scope screen

This DSP-based spectrum scope allows you to display the activity on the selected band, as well as the relative strengths of various signals.

**NOTE:** Spurious signal waveforms may be displayed. They are generated in the internal scope circuit and do not indicate a transceiver malfunction.

This transceiver has two spectrum scope modes. One is the Center mode, and another one is the Fixed mode.

You can also select Dual scope, Single scope, and Waterfall display ON or OFF for your convenience.

In addition, there is a Mini scope screen to save screen space.

### • Center mode screen

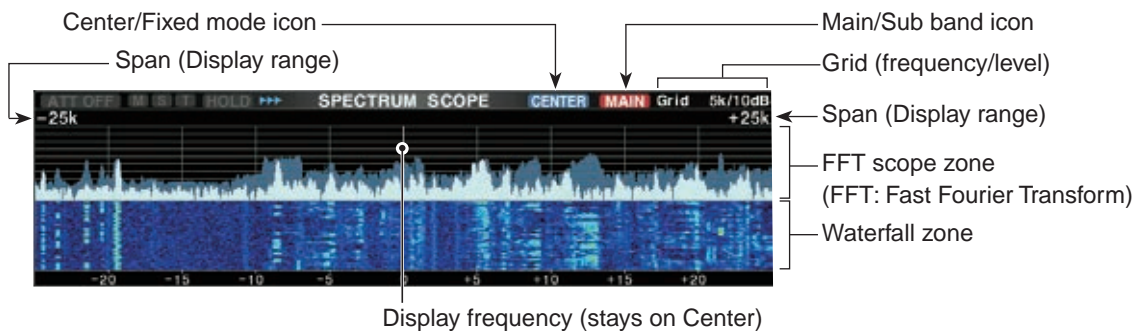

### • Fixed mode screen

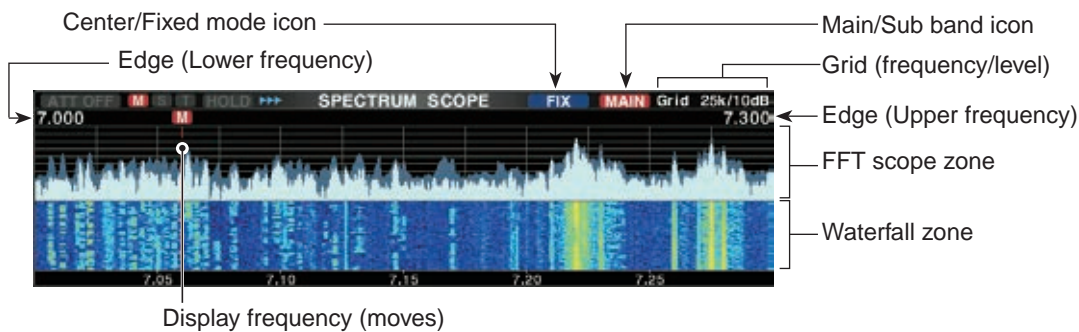

### • Center mode screen (Dual scope: Side by Side)

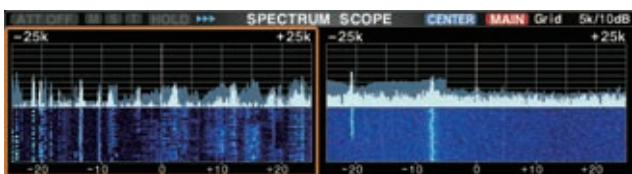

### • Fixed mode screen (Waterfall OFF)

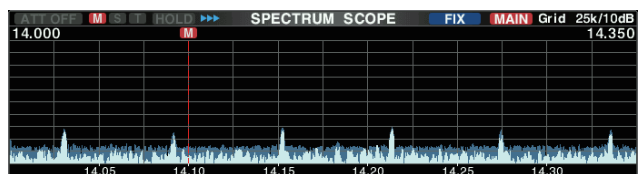

◇ Operating the Spectrum scope

○ The Multi-function screens are OFF:

① Push [SCOPE](F).

- The Spectrum scope screen is displayed.

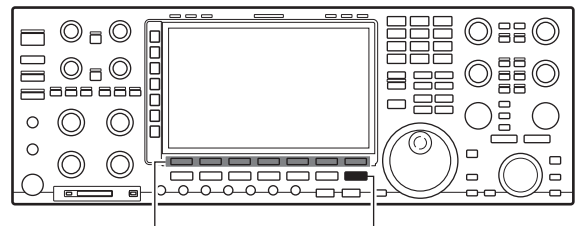

(F) Function keys [EXIT/SET]

Function	Action	
<MENU1> <MENU2>	Selects the Function menu.	
SPAN	When the Center mode is selected, selects the scope span. • Selectable spans: ±2.5, 5.0, 10, 25, 50, 100, 250 and 500 kHz • Hold down for 1 second to select the ±2.5 kHz span.	
EDGE	When the Fixed mode is selected, selects the Edge frequencies. • Upper and lower edge frequencies can be set in the Scope set screen.	
ATT	Push	Selects the Scope attenuator. • OFF, 10 dB, 20 dB, 30dB
	Hold down	Turns OFF the attenuator.
HOLD	Push	Selects the Hold function ON or OFF.
	Hold down	Clears the Peak hold level.
CENT/FIX	Selects the Center or Fixed mode.	
M/S DUAL	Push	Selects the Main or Sub band.
	Hold down	Selects the Dual or Single scope.
EXPD/ SET	Push	Selects the Expanded or Normal screen.
	Hold down	Enters the Scope set screen.
REF	Displays the Reference level window. (p. 6-8) • Push again to close the window. • Rotate [MAIN DIAL] to adjust the Reference level.	
SPEED	Selects the sweep speed. • “▶▶▶,” “▶▶,” or “▶” displays FAST, MID, or SLOW.	
MARKER	Selects the Marker.	

- The Spectrum scope with Sub band selection is enabled only when the Dualwatch or Split frequency operation.

② To exit the Spectrum scope screen, push [EXIT/SET].

• Spectrum scope screen

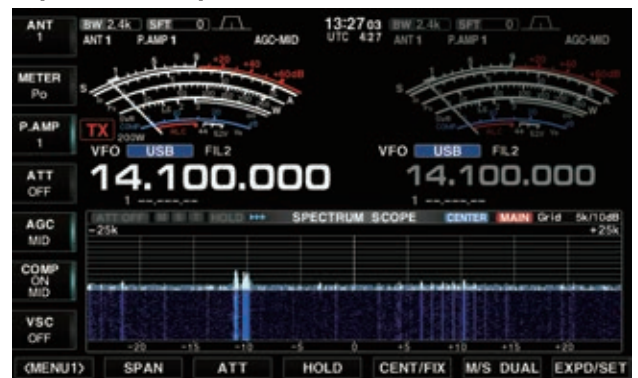

• Function menu (MENU2)



• Fixed mode screen (Dual scope)

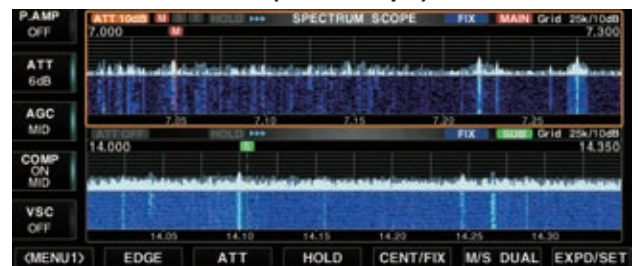

**NOTE:** If a strong signal is received, a ghost waveform may appear. If it appears, push [ATT](F) several times to enable the Scope attenuator.

## 6 SCOPE OPERATION

### ■ Spectrum scope screen (Continued)

#### ◇ Center mode

Displays signals around the operating frequency within the selected span. The operating frequency is always displayed in the center of the screen.

○ The Multi-function screens are OFF:

- ① Push [SCOPE](F).
  - The Spectrum scope screen is displayed.
- ② Push [CENT/FIX](F).
  - “**CENTER**” is displayed when the Center mode is selected.
  - Push [CENT/FIX](F) to toggle between the Center and Fixed modes.
- ③ Push [SPAN](F) several times to select the scope span.
  - Selectable span  
±2.5, 5.0, 10, 25, 50, 100, 250 and 500 kHz
  - Hold down [SPAN](F) for 1second to select the ±2.5 kHz span.
- ④ To exit the Spectrum scope screen, push [EXIT/SET].

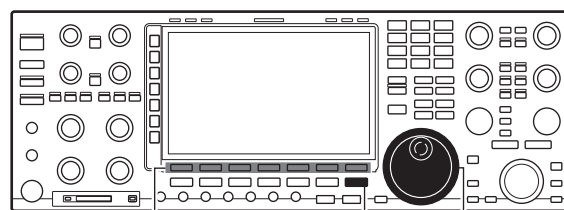

(F) Function keys [EXIT/SET] [MAIN DIAL]

#### • Center mode screen



#### • Center mode screen (Example: Span ±500 kHz)

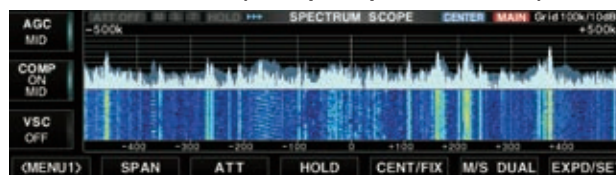

#### The Marker display in the Center mode

The Marker displays the operating frequency of the Main or Sub band in the Spectrum scope screen. However, the operating frequency stays on the Center of the screen when the Center mode is selected. Thus, the transceiver does not display the MAIN marker on the Main scope, nor the SUB marker on the Sub scope.

- When the Hold function is ON, the Marker is displayed to display the operating frequency's position.
- Marker types
  - M**: Main marker displays the operating frequency for Main band.
  - S**: Sub marker displays the operating frequency for Sub band.
  - T**: TX marker displays the transmit frequency.

➤ Push [MARKER](F) to select the marker.

- When Main scope is selected:
  - SUB, TX/SUB, TX, Marker OFF
- When Sub scope is selected:
  - MAIN, TX/MAIN, TX, Marker OFF
- When the Marker is displayed and the frequency is out of range, “<<” or “>>” appears at the upper side corners of the Spectrum scope screen.
  - <<: The frequency is too low.
  - >>: The frequency is too high.

#### • TX marker is ON

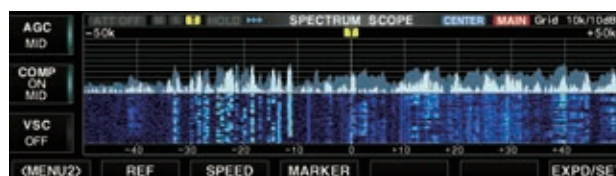



### ◇ Fixed mode

Displays signals within a specified frequency range. The selected frequency band activity can be observed at a glance when using this mode.

○ The Multi-function screens are OFF:

- ① Push [SCOPE](F).
  - The Spectrum scope screen is displayed.
- ② Push [CENT/FIX](F).
  - “**FIX**” is displayed when the Fixed mode is selected
  - Push [CENT/FIX](F) to toggle between the Center and Fixed modes.
- ③ Push [EDGE](F) several times to select the Edge frequency.
  - The upper or lower Edge frequencies can be changed in the Scope set screen. (p. 6-12)
  - Hold down [SPAN](F) for 1second to select the  $\pm 2.5$  kHz span.
  - When the operating frequency moves past the upper or lower Edge frequency, “<<” or “>>” appears at the upper side corners of the screen.
    - <<: The frequency is too low.
    - >>: The frequency is too high.
  - When the frequency goes further away, “Scope Out of Range” is displayed.
- ④ To exit the Spectrum scope screen, push [EXIT/SET].

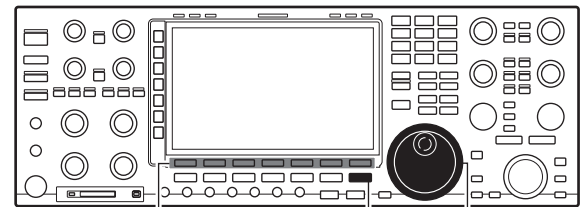

(F) Function keys [EXIT/SET] [MAIN DIAL]

### • Fixed mode screen

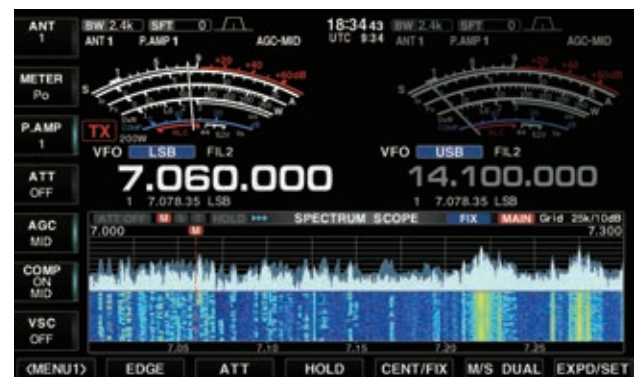

### The Marker display in the Fixed mode

In the Fixed mode, the Marker displays the operating frequency. So, the transceiver always displays the Main marker on the Main scope, or the Sub marker on the Sub scope.

#### • Marker types

- M**: Main marker displays the operating frequency for Main band.
- S**: Sub marker displays the operating frequency for Sub band.
- T**: TX marker displays the transmit frequency.

➔ Push [MARKER](F) to select the Marker.

- When the Main scope is selected:
  - MAIN/SUB, MAIN/TX, MAIN/SUB/TX, Only MAIN
- When the Sub scope is selected:
  - MAIN/SUB, SUB/TX, MAIN/SUB/TX, Only SUB
- When the Marker is displayed and the frequency is out of range, “<<” or “>>” appears at the upper side corners of the Spectrum scope screen.
  - <<: The frequency is too low.
  - >>: The frequency is too high.

### • The SUB maker is out of range (“>>” appears)

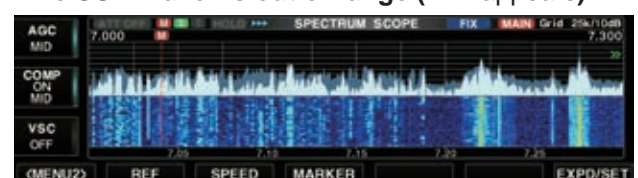

## 6 SCOPE OPERATION

### ■ Spectrum scope screen (Continued)

#### ◇ Dual scope screen

This transceiver has a Dual scope mode that simultaneously displays the Main and Sub scopes during Dualwatch operation.

You can select the “Over/Under” or “Side by Side” layout in the Scope set screen.

○ The Multi-function screens are OFF:

- ① Push [SCOPE](F).
  - The Spectrum scope screen is displayed.
- ② Hold down [M/S DUAL](F) for 1 second.
  - The Dual scope is displayed.
  - Hold down [M/S DUAL](F) for 1 second to toggle between the Dual and Single scopes.
- ③ Push [M/S DUAL](F).
  - Push [M/S DUAL](F) toggles between the Main and Sub scopes.
  - An orange frame moves and displays the selected side.
- ④ To exit the Spectrum scope screen, push [EXIT/SET].

#### • Dual scope screen (OVER/Under: Fixed mode)



#### • Dual scope screen (Side by Side: Center mode)

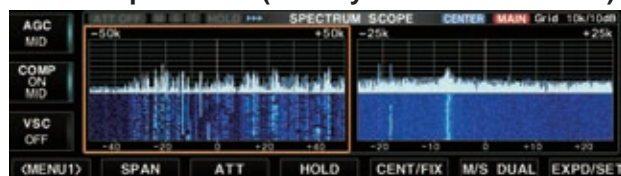

#### ◇ Mini scope screen

The Mini scope screen can be simultaneously displayed with another Multi-function displays, such as Set mode menu, RTTY/PSK decode screen, Memory list screen.

- Push [M.SCOPE] to turn the Mini scope screen ON or OFF.
  - Hold down [M.SCOPE] for 1 second to display the Spectrum scope screen.
  - When the Mini scope screen is displayed with the Scope set screen, you can select the setting by verifying the spectrum.

However, you cannot make changes using the Function keys, such as the Scope attenuator setting, Center/Fixed mode selection.

#### • Mini scope screen with the Set mode menu screen

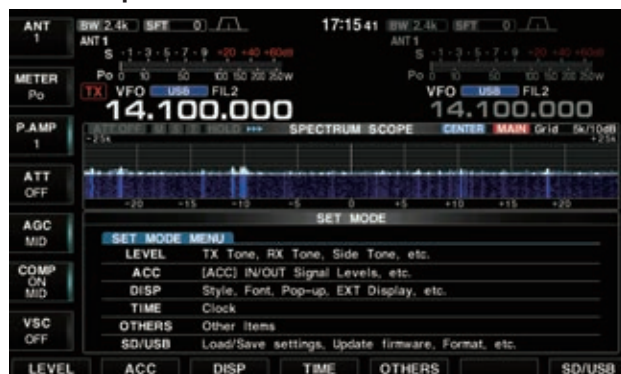

#### • Dual mini scope screen with the RTTY decode screen





◇ **Scope attenuator**

While operating in the band with a high noise floor, set the Scope attenuator to reduce the noise level.

- Even if the Scope attenuator is ON, it does not affect the receiver sensitivity.

○ The Multi-function screens are OFF:

- ① Push [SCOPE](F).
  - The Spectrum scope screen is displayed.
- ② Push [ATT](F) several times to select the Scope attenuator level.
  - Selectable levels: 10 dB, 20 dB, 30 dB, and OFF.
  - Hold down [ATT](F) for 1 second to turn the Scope attenuator OFF.
- ③ To exit the Spectrum scope screen, push [EXIT/SET].

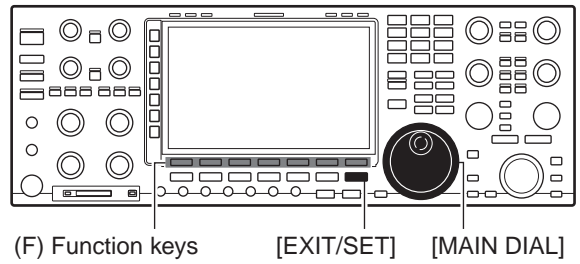

• **Scope attenuator (OFF)**

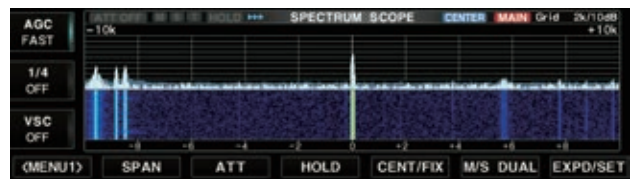

• **Scope attenuator (10 dB)**

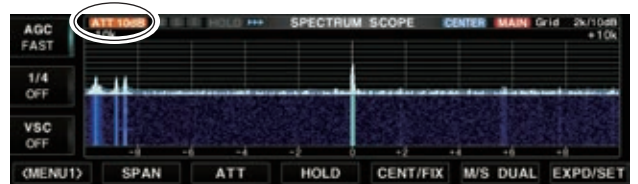

• **Scope attenuator (20 dB)**

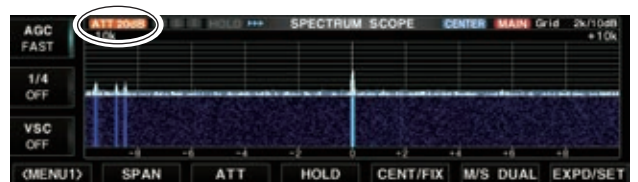

• **Scope attenuator (30 dB)**

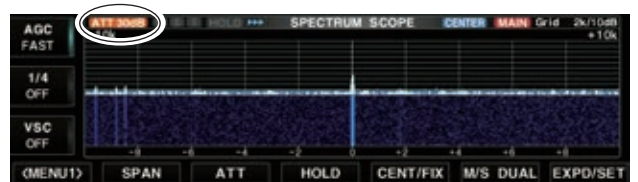

## 6 SCOPE OPERATION

### ■ Spectrum scope screen (Continued)

#### ◇ Adjusting the Reference level

When monitoring a weak signal that is buried in the noise floor, or monitoring a strong signal but some stronger signals is nearby, adjust the Reference level of the screen helps to see these signals.

- Even if this setting is changed, it does not affect the scope input level.

If you want to change the scope input level, set the Scope attenuator of 10 dB, 20 dB, or 30 dB.

- When you adjust the Reference level, the signal strength for the waterfall also appears to change.

- ① Display the Spectrum scope screen, then push [**<MENU1>**](F).

**SCOPE** [F-1] ▸ **<MENU1>** [F-1] ▸ *Displays <MENU2>*

- The function menu changes to Menu 2.

- ② Push [**REF**](F).

- Displays the Reference level window.
- Push again to close the window.

- ③ Rotate [**MAIN DIAL**] to adjust the level.

- Adjustable range:  $-20.0\text{ dB} \sim +20.0\text{ dB}$ .
- Hold down [**REF**](F) for 1 second to select  $\pm 0.0\text{ dB}$ .

- ④ Push [**REF**](F).

- ⑤ To exit the Spectrum scope screen, push [**EXIT/SET**].

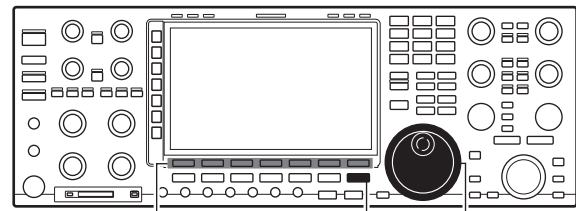

(F) Function keys

[EXIT/SET]

[MAIN DIAL]

#### • Function menu (MENU2)



#### • Reference level ( $\pm 0.0\text{ dB}$ )

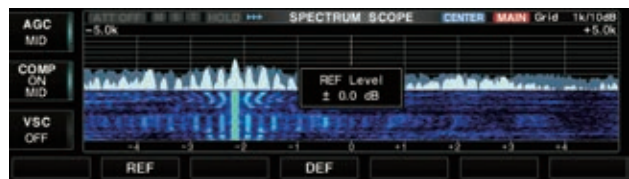

#### • Difference spectrum ( $+20.0\text{ dB}$ , $\pm 0.0\text{ dB}$ , $-20.0\text{ dB}$ )

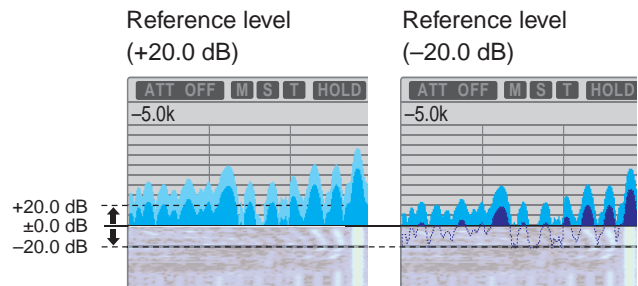

#### • Display example ( $+20.0\text{ dB}$ )

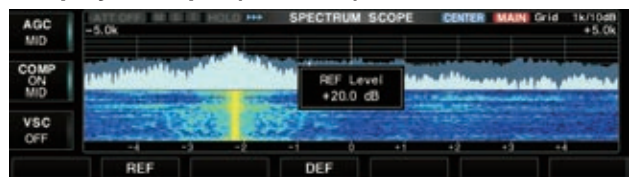

All signal levels appear stronger.

#### • Display example ( $-20.0\text{ dB}$ )



All signal levels appear weaker.

### ◇ Sweep speed

Select the sweep speed to change the FFT (Fast Fourier Transform) scope renew speed and the waterfall speed.

- If you want to change only the waterfall speed, you can select “SLOW,” “MID,” or “FAST” in the Scope set screen.

- ① Display the Spectrum scope screen, then push [**<MENU1>**](F).

**SCOPE** [F-1] ↘ **<MENU1>** [F-1] ↘ *Displays <MENU2>*

- The function menu changes to Menu 2.

- ② Push [**SPEED**](F) several times.

- Selectable speeds: FAST, MID, or SLOW.
- “▶▶▶,” “▶▶,” or “▶” displays FAST, MID, or SLOW.

- ③ To exit the Spectrum scope screen, push [**EXIT/SET**].

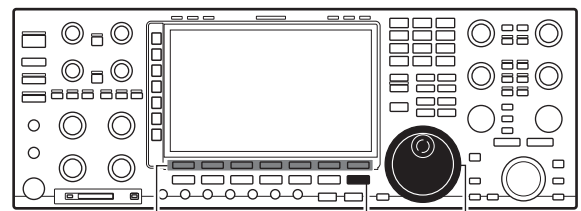

(F) Function keys

[EXIT/SET]

[MAIN DIAL]

#### • Function menu (MENU2)

[<MENU2>] REF SPEED MARKER EXPD/SET

#### • Sweep speed (FAST)

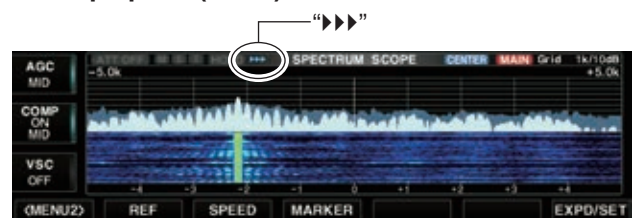

#### • Sweep speed (MID)

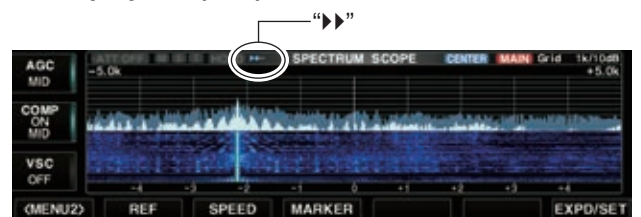

#### • Sweep speed (SLOW)

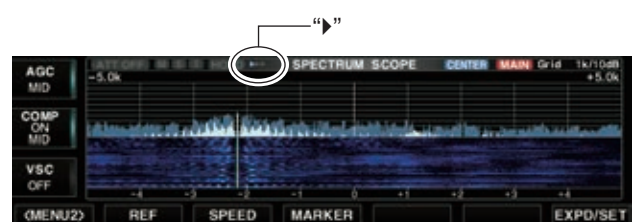

## 6 SCOPE OPERATION

### ■ Spectrum scope screen (Continued)

#### ◇ Scope set screen

This Set screen is used to set the waveform color, Scope range for the Fixed mode, and so on.

- ① Display the Spectrum scope screen, then hold down [EXPD/SET](F) for 1 second.

**SCOPE [F-1] ▸ EXPD/SET [F-7]**

- The Scope set screen is displayed.
- ② Push [▲](F) or [▼](F) to select the desired item.
    - Push [◀ ▶] to select the contents for various items.
  - ③ Rotate [MAIN DIAL] to select the option or set the level.
    - Hold down [DEF](F) for 1 second to select the default option or level.
  - ④ Push [EXIT/SET].
    - Exits the Set screen.

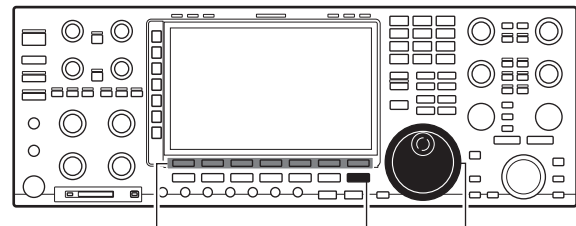

(F) Function keys [EXIT/SET] [MAIN DIAL]

#### • Scope set screen

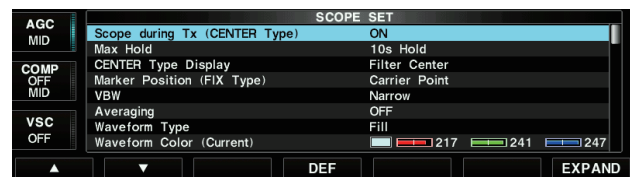

### Scope during TX (CENTER TYPE)

(Default: ON)

Select the TX signal display ON or OFF.

### Max Hold (Default: 10s Hold)

Select the peak level holding function.

- OFF: Turns OFF the peak level holding function.
- 10s Hold: Holds the peak spectrum for 10 seconds.
- ON: Holds the peak spectrum.

### CENTER Type Display

(Default: Filter Center)

Select the center frequency of the Spectrum scope display. (Only in the Center mode)

- Filter center: Displays the selected filter's center frequency at the center of the Spectrum scope screen.
- Carrier Point Center: Displays the carrier point frequency of the selected operating mode at the center of the Spectrum scope screen.
- Carrier Point Center (Abs. Freq.): In addition to the carrier point center setting above, the actual frequency is displayed at the bottom of the scope.

### Marker Position (Fix Type)

(Default: Carrier Point)

Select the marker position of the Spectrum scope display. (Only in the Fixed mode)

- Filter center: Displays the Marker on the selected filter's center frequency.
- Carrier Point: Displays the Marker on the carrier point frequency of the selected operating mode.

### VBW (Default: Narrow)

Select the VBW (Video Band Width).

- Narrow: Sets the VBW to narrow.
- Wide: Sets the VBW to wide.

When "Wide" is selected, the line drawn on the receive spectrum becomes wide. However, the small edge cannot be drawn.

### Averaging (Default: OFF)

Set the FFT scope waveform averaging function to between 2 and 4, or OFF.

- OFF: The FFT scope screen renews at each sweep time. This setting displays the critical spectrum view.
- 2, 3, 4: The FFT scope screen averages 2 to 4 sweeps to smoothly display the spectrum.

**Waveform Type** (Default: Fill)

Select the outline waveform display for the Spectrum scope.

- Fill: The waveform is drawn only in color.
- Fill + Line: The waveform is drawn in color with an outline.

**Waveform Color (Current)**  
(Default: (R) 217 (G) 241 (B) 247)

Set the waveform outline color for the currently received signals.

- The color is set in the RGB format.
- Push [◀ ▶](F) to select R (Red), G (Green) and B (Blue). Rotate [MAIN DIAL] to adjust the ratio from 0 to 255.
- The color is displayed in the box beside the RGB scale.

**Waveform Color (Line)**  
(Default: (R) 70 (G) 30 (B) 0)

Set the waveform outline color for the currently received signals.

- The color is set in the RGB format.
- Push [◀ ▶](F) to select R (Red), G (Green) and B (Blue). Rotate [MAIN DIAL] to adjust the ratio from 0 to 255.
- The color is displayed in the box beside the RGB scale.

**Waveform Color (Max Hold)**  
(Default: (R) 58 (G) 110 (B) 147)

Set the waveform color for the received signals maximum level.

- The color is set in the RGB format.
- Push [◀ ▶](F) to select R (Red), G (Green) and B (Blue). Rotate [MAIN DIAL] to adjust the ratio from 0 to 255.
- The color is displayed in the box beside the RGB scale.

**Waterfall Display** (Default: ON)

Turn the Water fall display ON or OFF for the normal scope or Mini scope screen. (In the Expanded scope screen, the Waterfall is always displayed.)

- OFF: Turns OFF the Waterfall display.
- ON: Turns ON the Waterfall display.

**Waterfall Speed** (Default: MID)

Select the Waterfall speed.

- SLOW: Sets the waterfall speed to SLOW.
- MID: Sets the waterfall speed to MID.
- FAST: Sets the waterfall speed to FAST.

**Waterfall Size (Expand Scope)**  
(Default: Mid)

Select the Waterfall height in the Expand scope screen.

- Small: The same height with the Normal scope screen, only the FFT scope expands.
- Mid: The Waterfall height expands same ratio with the FFT scope.
- Large: Only the Waterfall height expands.

**Waterfall Peak Color Level**  
(Default: Grid 10)

Select the signal level that the Waterfall displays a peak color.

Higher signal levels are Red, Yellow, Green, Light-blue, Blue and Black in order.

- Selection: Grid 1 ~ Grid 10

**Waterfall Marker Auto-hide**  
(Default: ON)

Select the Waterfall Marker Auto-hide function ON or OFF.

- OFF: The marker in the Waterfall zone stays ON.
- ON: The marker in the Waterfall zone is hidden 2 seconds after you have stopped it in place.

**Dual Scope Type** (Default: Over/Under)

When the Dual scope is selected, select the Main and Sub scope layout.

- Over/Under: Displays the Main scope over the Sub scope.
- Side by Side: Displays the Main and Sub scopes side by side.



### ■ Spectrum scope screen (Continued)

#### Dual Scope Auto Select (Default: ON)

When the Dual scope is selected, the band selection keys, [MAIN] and [SUB] simultaneously select the Main or Sub scope.

- OFF: Push [M/S DUAL](F) or click the mouse button to select the Main or Sub scope.
- ON: Push [M/S DUAL](F) or click the mouse button to select the Main or Sub scope. In addition, push the [MAIN] or [SUB] key to select the operating band, and automatically select the Main or Sub scope.

#### Fixed Edges (0.03 – 1.60)

(Default: 0.500–1.500 MHz)  
(Default: 0.500–1.500 MHz)  
(Default: 0.500–1.500 MHz)

Set the Upper and Lower Edge frequencies for the Fixed mode. Three edges are assigned to each band. Push [EDGE](F) to select the edge.

- Selectable range: 0.030 ~ 1.600 MHz
- Push [◀ ▶](F) to select Upper or Lower frequency, and rotate [MAIN DIAL] to select the frequency.

#### Fixed Edges (1.60 – 2.00)

(Default: 1.800–2.000 MHz)  
(Default: 1.800–1.830 MHz)  
(Default: 1.900–1.930 MHz)

Set the Upper and Lower Edge frequencies for the Fixed mode. Three edges are assigned to each band. Push [EDGE](F) to select the edge.

- Selectable range: 1.600 ~ 2.000 MHz
- Push [◀ ▶](F) to select Upper or Lower frequency, and rotate [MAIN DIAL] to select the frequency.

#### Fixed Edges (2.00 – 6.00)

(Default: 3.500–4.000 MHz)  
(Default: 3.500–3.575 MHz)  
(Default: 3.750–3.850 MHz)

Set the Upper and Lower Edge frequencies for the Fixed mode. Three edges are assigned to each band. Push [EDGE](F) to select the edge.

- Selectable range: 2.000 ~ 6.000 MHz
- Push [◀ ▶](F) to select Upper or Lower frequency, and rotate [MAIN DIAL] to select the frequency.

#### Fixed Edges (6.00 – 8.00)

(Default: 7.000–7.300 MHz)  
(Default: 7.000–7.030 MHz)  
(Default: 7.030–7.200 MHz)

Set the Upper and Lower Edge frequencies for the Fixed mode. Three edges are assigned to each band. Push [EDGE](F) to select the edge.

- Selectable range: 6.000 ~ 8.000 MHz
- Push [◀ ▶](F) to select Upper or Lower frequency, and rotate [MAIN DIAL] to select the frequency.

#### Fixed Edges (8.00 – 11.00)

(Default: 10.100–10.150 MHz)  
(Default: 10.100–10.130 MHz)  
(Default: 10.130–10.150 MHz)

Set the Upper and Lower Edge frequencies for the Fixed mode. Three edges are assigned to each band. Push [EDGE](F) to select the edge.

- Selectable range: 8.000 ~ 11.000 MHz
- Push [◀ ▶](F) to select Upper or Lower frequency, and rotate [MAIN DIAL] to select the frequency.

#### Fixed Edges (11.00 – 15.00)

(Default: 14.000–14.350 MHz)  
(Default: 14.000–14.100 MHz)  
(Default: 14.100–14.350 MHz)

Set the Upper and Lower Edge frequencies for the Fixed mode. Three edges are assigned to each band. Push [EDGE](F) to select the edge.

- Selectable range: 11.000 ~ 15.000 MHz
- Push [◀ ▶](F) to select Upper or Lower frequency, and rotate [MAIN DIAL] to select the frequency.

#### Fixed Edges (15.00 – 20.00)

(Default: 18.068–18.168 MHz)  
(Default: 18.068–18.110 MHz)  
(Default: 18.110–18.168 MHz)

Set the Upper and Lower Edge frequencies for the Fixed mode. Three edges are assigned to each band. Push [EDGE](F) to select the edge.

- Selectable range: 15.000 ~ 20.000 MHz
- Push [◀ ▶](F) to select Upper or Lower frequency, and rotate [MAIN DIAL] to select the frequency.

**Fixed Edges (20.00 – 22.00)**

(Default: 21.000–21.450 MHz)

(Default: 21.000–21.150 MHz)

(Default: 21.150–21.450 MHz)

Set the Upper and Lower Edge frequencies for the Fixed mode. Three edges are assigned to each band. Push [EDGE](F) to select the edge.

- Selectable range: 20.000 ~ 22.000 MHz
- Push [◀ ▶](F) to select Upper or Lower frequency, and rotate [MAIN DIAL] to select the frequency.

**Fixed Edges (22.00 – 26.00)**

(Default: 24.890–24.990 MHz)

(Default: 24.890–24.930 MHz)

(Default: 24.930–24.990 MHz)

Set the Upper and Lower Edge frequencies for the Fixed mode. Three edges are assigned to each band. Push [EDGE](F) to select the edge.

- Selectable range: 22.000 ~ 26.000 MHz
- Push [◀ ▶](F) to select Upper or Lower frequency, and rotate [MAIN DIAL] to select the frequency.

**Fixed Edges (26.00 – 30.00)**

(Default: 28.000–29.000 MHz)

(Default: 28.000–28.200 MHz)

(Default: 28.200–29.000 MHz)

Set the Upper and Lower Edge frequencies for the Fixed mode. Three edges are assigned to each band. Push [EDGE](F) to select the edge.

- Selectable range: 26.000 ~ 30.000 MHz
- Push [◀ ▶](F) to select Upper or Lower frequency, and rotate [MAIN DIAL] to select the frequency.

**Fixed Edges (30.00 – 45.00)**

(Default: 30.000–31.000 MHz)

(Default: 30.000–31.000 MHz)

(Default: 30.000–31.000 MHz)

Set the Upper and Lower Edge frequencies for the Fixed mode. Three edges are assigned to each band. Push [EDGE](F) to select the edge.

- Selectable range: 30.000 ~ 45.000 MHz
- Push [◀ ▶](F) to select Upper or Lower frequency, and rotate [MAIN DIAL] to select the frequency.

**Fixed Edges (45.00 – 60.00)**

(Default: 50.000–51.000 MHz)

(Default: 50.000–50.100 MHz)

(Default: 50.100–50.300 MHz)

Set the Upper and Lower Edge frequencies for the Fixed mode. Three edges are assigned to each band. Push [EDGE](F) to select the edge.

- Selectable range: 45.000 ~ 60.000 MHz
- Push [◀ ▶](F) to select Upper or Lower frequency, and rotate [MAIN DIAL] to select the frequency.



## 6 SCOPE OPERATION

### ■ Spectrum scope screen (Continued)

#### ◇ USB mouse operation

If you connect a USB mouse to the transceiver, a mouse pointer appears on the Spectrum scope screen. Now, you can change the frequency or settings by using the mouse.

- Clicking while holding down [XFC] changes the transmit frequency.
- In the Dual scope mode, if you click the FFT scope or Waterfall zone of the unselected side, the unselected side first changes to the selected side.

#### • Changing frequency on the Center mode screen

Button	Operation	Description
Left	Click	The frequency changes to the clicked point and the mouse pointer moves to the center of the screen.
	Drag	The frequency changes to the clicked point and the mouse pointer moves to the center of the screen, and then the frequency increases or decreases.
Right	Click/Drag	The Right button temporarily changes the frequency. While holding the button, same action as the Left button, but release it to return to the original frequency.

#### • Changing frequency on the Fixed mode screen

Button	Operation	Description
Left	Click	The frequency and Marker change to the clicking point.
	Drag	The frequency and Marker change to the clicking point, and then the frequency increases or decreases.
Right	Click/Drag	The Right button temporarily changes the frequency. While holding the button, same action as the Left button, but release it to return to the original frequency.

#### • Center mode screen

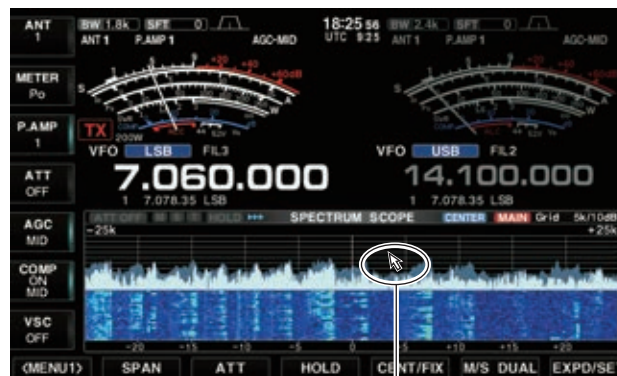

Mouse pointer

#### • Mouse operation

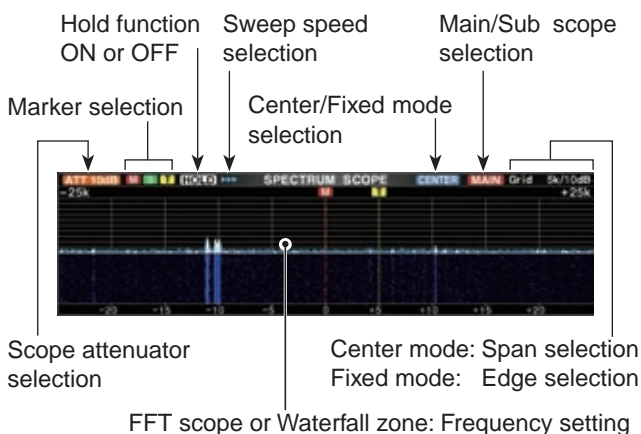

#### • Mouse operation in the Dual scope screen

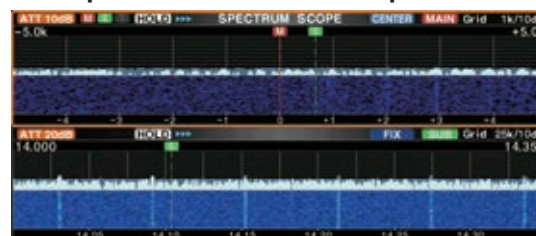

Clicking the FFT scope or Waterfall zone of the unselected side changes it to the selected side.

- The orange frame moves to the clicked side.
- You can change any other than the frequency setting in the unselected side. In that case, the orange frame does not move.

## ■ Audio scope screen

This audio scope allows you to display the received signal's frequency component on the FFT scope, and its waveform components on the Oscilloscope. The FFT scope has an waterfall.

**NOTE:**

When the Monitor function is ON, you can see the TX audio on the Audio scope.

○ The Multi-function screens are OFF:

① Push [AUDIO](F).

- The Audio scope screen is displayed.

Function	Action	
MAIN/ SUB	Selects the Main or Sub band.	
ATT	Push	Selects the Attenuator for the FFT scope. • 0 (OFF), 10, 20, or 30dB
	Hold down	Turns OFF the attenuator. (0 dB)
HOLD	Sets the Hold function to ON or OFF. • " <b>HOLD</b> " is displayed and freezes the current audio spectrum.	
LEVEL	Selects the Oscilloscope level. • 0, -10, -20, or -30 dB	
TIME	Selects the Oscilloscope sweep time. • 1, 3, 10, 30, 100, or 300 ms/Div	
SET	Enters the Scope set screen.	

- The Audio scope with Sub band selection is enabled only during Dualwatch or Split frequency operation.

② To exit the Audio scope screen, push [EXIT/SET].

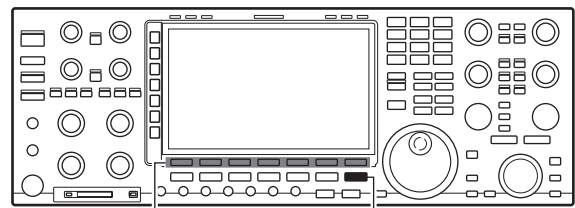

(F) Function keys [EXIT/SET]

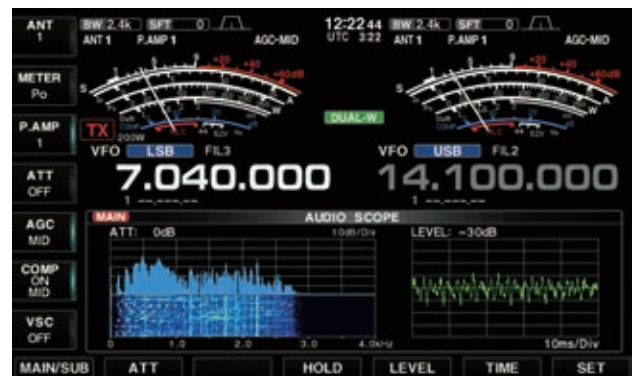

• Audio scope screen

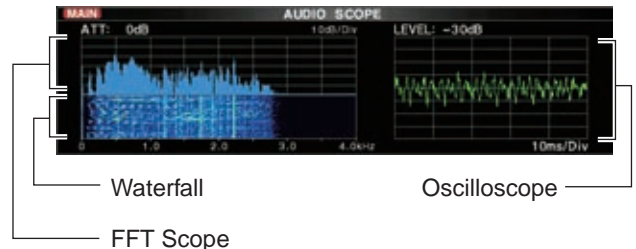

## 6 SCOPE OPERATION

### ■ Audio scope screen (Continued)

#### ◇ Audio scope set mode

This set mode is used to set the FFT scope waveform type, color, Waterfall display and oscilloscope waveform color.

- ① Display the Audio scope screen, then hold down [SET](F) for 1 second.

**AUDIO [F-6] ↘ SET [F-7]**

- The Audio scope set screen is displayed.
- ② Push [▲](F) or [▼](F) to select the desired item.
    - Push [◀ ▶] to select the contents for various items.
  - ③ Rotate [MAIN DIAL] to select the option or set the level.
    - Hold down [DEF](F) for 1 second to select the default option or level.
  - ④ Push [EXIT/SET].
    - Exits the Set screen.

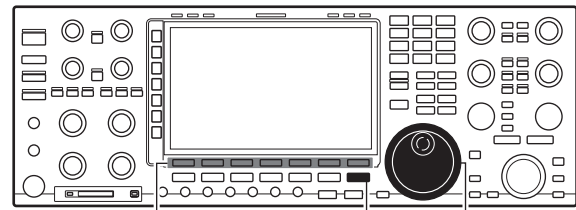

(F) Function keys [EXIT/SET] [MAIN DIAL]

#### • Audio scope set screen

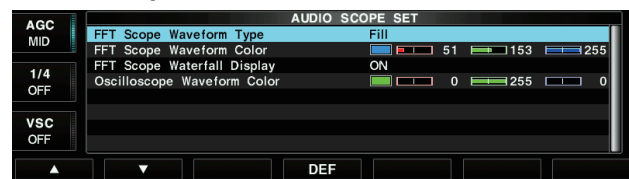

#### FFT Scope Waveform Type

(Default: Fill)

Select the type of waveform for the FFT scope.

- Fill: The waveform is drawn by only the color.
- Line: The waveform is drawn by only outline.

#### FFT Scope Waveform Color

(Default: (R) 51 (G) 153 (B) 255)

Set the waveform color for the FFT scope.

- The color is set in RGB format.
- Push [◀ ▶](F) to select R (Red), G (Green) and B (Blue). Rotate [MAIN DIAL] to adjust the ratio from 0 to 255.
- The color is displayed in the box beside the RGB scale.

#### FFT Scope Waterfall Display

(Default: ON)

Turn the Waterfall display ON or OFF.

- OFF: Turns OFF the Waterfall display.
- ON: Turns ON the Waterfall display.

#### Oscilloscope Waveform Color

(Default: (R) 0 (G) 255 (B) 0)

Set the waveform color for the Oscilloscope.

- The color is set in the RGB format.
- Push [◀ ▶](F) to select R (Red), G (Green) and B (Blue). Rotate [MAIN DIAL] to adjust the ratio from 0 to 255.
- The color is displayed in the box beside the RGB scale.

---

■ Preamplifier .....	7-2
■ Attenuator .....	7-2
■ RIT function.....	7-3
◇ RIT monitor function .....	7-3
■ AGC function control .....	7-4
◇ Selecting the preset value .....	7-4
◇ Adjusting the AGC time constant .....	7-4
◇ Setting the AGC time constant preset value .....	7-4
■ Twin PBT operation .....	7-5
■ IF filter selection .....	7-6
◇ IF filter selection.....	7-6
◇ DSP filter shape .....	7-7
◇ Roofing filter selection .....	7-7
◇ 1.2 kHz Filter calibration .....	7-8
◇ Filter shape set mode .....	7-9
■ Dualwatch operation .....	7-10
■ Noise blanker .....	7-11
◇ NB Set mode .....	7-11
■ Noise reduction .....	7-12
■ Digital selector .....	7-12
■ Notch function.....	7-13
◇ Auto notch function .....	7-13
◇ Manual notch function .....	7-13
■ Auto tuning function .....	7-14
■ Main/Sub band Tracking function.....	7-14
◇ Turning ON the Tracking function .....	7-14

## ■ Preamplifier

The preamp amplifies received signals in the receiver front end to improve the signal-to-noise ratio and sensitivity. Set this to P.AMP 1 or P.AMP 2 when receiving weak signals.

- Push the Multi-function [P.AMP](▶) key several times to turn ON preamp 1 or preamp 2, or to turn OFF the preamp.
- Hold down the Multi-function [P.AMP](▶) key for 1 second to turn OFF the preamp.

**NOTE:** The preamp (P.AMP 1 or P.AMP 2) cannot be used while the Digital RF selector is in use. Also the preamp is automatically disabled when the Digital RF selector is turned ON.

### ✓ About P.AMP 2

P.AMP 2 is a high gain receive amplifier. When it is used during times of strong electric fields, distortion sometimes results. In such cases, set the transceiver to “P.AMP 1” or “P.AMP OFF.”

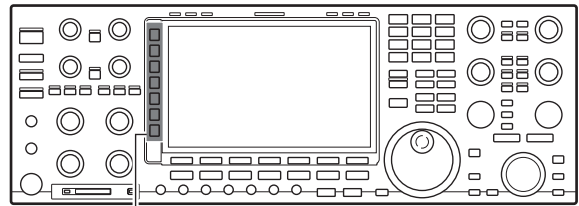

(▶) Multi-function keys

### • When selecting Preamp 1



<b>P.AMP 1</b>	Especially for maintaining IP3. Gain is approximately 12 dB.
<b>P.AMP 2</b>	High-gain preamp for all bands. Gain is approximately 20 dB.

## ■ Attenuator

The attenuator prevents a desired signal from becoming distorted when very strong signals are near the frequency or when very strong electric fields, such as from broadcasting stations, are near your location.

- Push the Multi-function [ATT](▶) key several times to set the attenuator to 6 dB, 12 dB, 18 dB or turn OFF the attenuator.
- Hold down the Multi-function [ATT](▶) key for 1 second several times to set the attenuator to 3 dB, 6 dB, 9 dB, 12 dB, 15 dB, 18 dB, 21 dB or to turn OFF the attenuator.

### • When selecting Attenuator (6 dB)



## ■ RIT function

The RIT (Receive Increment Tuning) function compensates for differences in frequencies of other stations. The function shifts the receive frequency up to  $\pm 9.99$  kHz in 10 Hz steps, without moving the transmit frequency.

- ① Push [RIT] to turn ON the RIT function.
  - “RIT” and the shift frequency are displayed.
- ② Rotate the [RIT/ $\Delta$ TX] control.
  - Hold down [CLEAR] for 1 second to reset the RIT frequency.
  - Push [CLEAR] momentarily to reset the RIT frequency when the quick RIT/ $\Delta$ TX clear function is ON. (p. 15-15)  
(SET [F-7] > OTHER [F-5] > Quick RIT/ $\Delta$ TX Clear)
  - Hold down [RIT] for 1 second to add the frequency shift to the operating frequency.
- ③ After communicating, push [RIT] to turn OFF the RIT function.

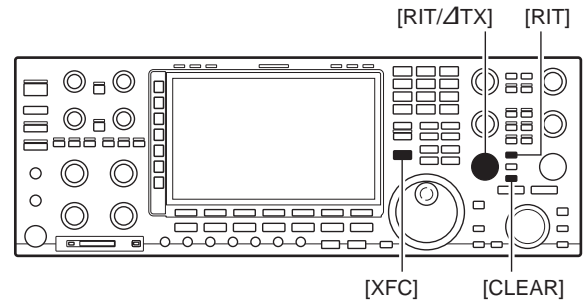

### • When selecting RIT function



### ◇ RIT monitor function

When the RIT function is ON, holding down [XFC] allows you to directly monitor the operating frequency (RIT is temporarily cancelled).



## AGC function control

The AGC (Automatic Gain Control) controls receiver gain to produce a constant audio output level, even when the received signal strength varies greatly.

The transceiver has three preset AGC settings (time constants: fast, mid, slow) for non-FM modes.

The FM mode AGC time constant is fixed as 'FAST' (0.1 seconds) and the AGC time constant cannot be selected.

### Selecting the preset value

- ① Select a non-FM mode.
- ② Push the Multi-function [AGC] key several times to select AGC fast, mid or slow.
  - Hold down [AGC VR] for 1 second to turn OFF the AGC function.

### Adjusting the AGC time constant

- ① Select a non-FM mode.
- ② Push [AGC VR], then rotate the [AGC] control to adjust the time constant.
  - The [AGC VR] indicator lights.
  - "VR" is displayed to the right of the Multi-function [AGC] key.
  - To set the time constant to fast, rotate to the right. And to set the time constant to slow, rotate to the left.

### Setting the AGC time constant preset value

- ① Select a non-FM mode.
- ② Push the Multi-function [AGC] key several times to select AGC fast, mid or slow.
- ③ Hold down the Multi-function [AGC] key for 1 second.
  - The AGC screen is displayed.
- ④ Rotate [MAIN DIAL] to set the desired time constant.
  - The selectable time constant is shown to the right.
  - Hold down [DEF](F) for 1 second to select the default value.
  - While in the AGC Set mode, you can select the AGC or the operating mode.
- ⑤ Push [EXIT/SET].
  - Exits the AGC screen.

**NOTE:** When you are receiving a weak signal, and a strong signal is momentarily received, the AGC function quickly reduces the receiver gain. When that signal disappears, the transceiver may not receive the weak signal because of the AGC action. In that case, select AGC fast, or hold down [AGC-VR] for 1 second to turn OFF the time constant.

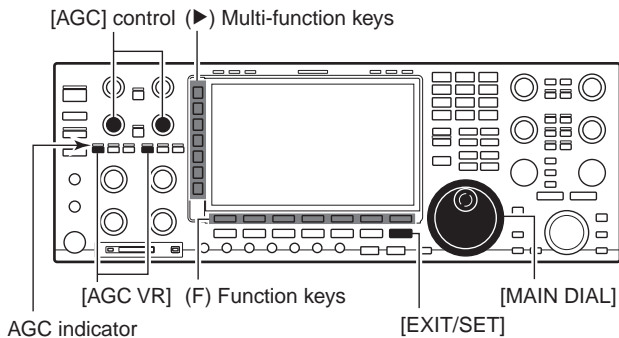

• When selecting "AGC-MID"



• When selecting "AGC-VR"



### The AGC screen

		AGC					
AGC MID		SSB	CW	RTTY	PSK	AM	FM
COMP OFF MID		FAST	0.3	0.1	0.1	3.0	0.1
		MID	2.0	0.5	0.5	5.0	---
VSC OFF		SLOW	6.0	1.2	1.2	7.0	---
		(sec.)					

### Selectable AGC time constant (unit: seconds)

Mode	Default	Selectable AGC time constant
SSB	0.3 (FAST)	0.1, 0.2, 0.3, 0.5, 0.8, 1.2, 1.6, 2.0, 2.5, 3.0, 4.0, 5.0, 6.0
	2.0 (MID)	
	6.0 (SLOW)	
CW	0.1 (FAST)	0.1, 0.2, 0.3, 0.5, 0.8, 1.2, 1.6, 2.0, 2.5, 3.0, 4.0, 5.0, 6.0
	0.5 (MID)	
	1.2 (SLOW)	
RTTY PSK	0.1 (FAST)	0.1, 0.2, 0.3, 0.5, 0.8, 1.2, 1.6, 2.0, 2.5, 3.0, 4.0, 5.0, 6.0
	0.5 (MID)	
	1.2 (SLOW)	
AM	3.0 (FAST)	0.3, 0.5, 0.8, 1.2, 1.6, 2.0, 2.5, 3.0, 4.0, 5.0, 6.0, 7.0, 8.0
	5.0 (MID)	
	7.0 (SLOW)	
FM	0.1 (FAST)	0.1 (Fixed)



## ■ Twin PBT operation

In general, the PBT (Passband Tuning) electronically narrows the IF passband width by shifting the IF frequency to slightly outside of the IF filter passband, to reject interference. The transceiver uses DSP for the PBT function.

▨ You can watch the nearby intended signal using the spectrum scope. (p. 6-2)

- ① Rotate [PBT1] (inner control) and [PBT2] (outer control) to the opposite direction from each other to narrow the IF passband width.
  - Before rotating, the PBT settings of [PBT1] and [PBT2] should be cleared.
  - Rejects interference of both higher and lower passbands. If you rotate the control too much, the received audio may not be heard because the passband width is too narrow.
  - Displays the passband width and shift frequency.
  - The [PBT CLEAR] indicator lights.
  - Hold down [PBT CLEAR] for 1 second to clear the PBT setting. In that case, the [PBT CLEAR] indicator goes OFF.
  - The variable range depends on the passband width and the operating mode. The edge of the variable range is half of the passband width. The PBT is adjustable in 25 Hz steps in the SSB/CW/RTTY/PSK modes, and 100 Hz in the AM mode.
  - Moving both [TWIN PBT] controls to the same position shifts the IF left or right.
- ② Hold down [FILTER] for 1 second.
  - The Filter screen is displayed. The current passband width and shift frequency are displayed.
- ③ Push [EXIT/SET].
  - Exits the Filter screen.

▨ **NOTE:** While rotating the [TWIN PBT] controls, noise may be heard. This comes from the DSP unit and does not indicate an equipment malfunction.

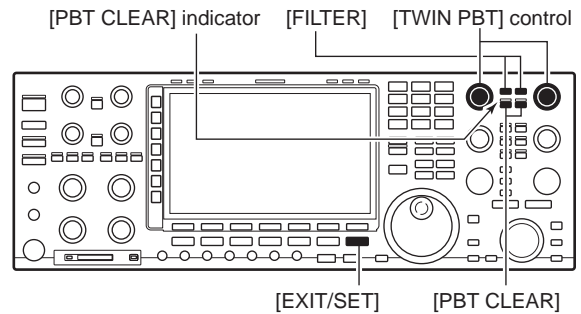

### • When operating [TWIN PBT]

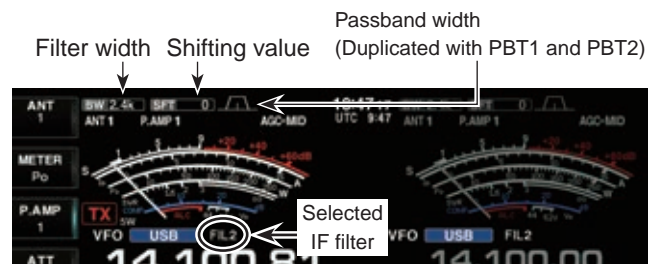

### • Filter screen when operating [TWIN PBT]



### • About Passband width and Shift value on the screen

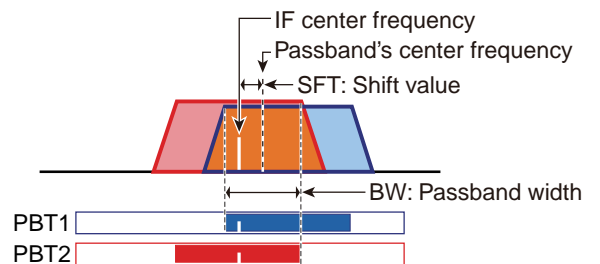

### • PBT operation example

PBT is OFF

IF center frequency

Cutting a lower passband

Passband

Interference Desired signal

Cutting both higher and lower passbands

Passband

Interference Desired signal Interference

## IF filter selection

The transceiver has 3 IF filter passband widths for each mode, and are selectable in the Filter screen. You can toggle the IF filter between FIL1 (Wide), FIL2 (Mid) and FIL3 (Narrow) by pushing [FILTER]. The IF filter passband widths for each mode can be changed in the Filter screen.

### IF filter selection

- ① Hold down [FILTER] for 1 second.
  - The Filter screen is displayed.
- ② Select any mode except FM.
  - Passband widths for the FM modes are fixed, and cannot be changed.
- ③ Push [FILTER] several times to set the desired IF filter to FIL1 (Wide), FIL2 (Mid) or FIL3 (Narrow).
- ④ Push [BW](F) to enter the passband width adjustment mode.
  - “BW” blinks.
- ⑤ Rotate [MAIN DIAL] to adjust the desired passband width.
  - The PBT shift frequencies are cleared when the passband width is changed.
  - Hold down [DEF](F) for 1 second to select the default value.
  - When the passband width is set to 500 Hz or less in the SSB or CW mode, the bandpass filter for receive is automatically selected, and “BPF” is displayed
- ⑥ Push [BW](F).
- ⑦ Repeat steps ② to ⑥ to set another mode’s passband width.
- ⑧ Push [EXIT/SET].
  - Exits the Filter screen.

▨ The filter selection is automatically memorized in each mode.  
 ▨ The PBT shift range is automatically memorized in each filter.

Mode	IF filter	Adjustable range (steps)
SSB	FIL1 (3.0 kHz)	50 to 500 Hz (50 Hz)
	FIL2 (2.4 kHz)	600 Hz to 3.6 kHz (100 Hz)
	FIL3 (1.8 kHz)	
SSB-D	FIL1 (3.0 kHz)	50 to 500 Hz (50 Hz)
	FIL2 (1.2 kHz)	600 Hz to 3.6 kHz (100 Hz)
	FIL3 (500 Hz)	
CW PSK	FIL1 (1.2 kHz)	50 to 500 Hz (50 Hz)
	FIL2 (500 Hz)	600 Hz to 3.6 kHz (100 Hz)
	FIL3 (250 Hz)	
RTTY	FIL1 (2.4 kHz)	50 to 500 Hz (50 Hz)
	FIL2 (500 Hz)	600 Hz to 2.7 kHz (100 Hz)
	FIL3 (250 Hz)	
AM AM-D	FIL1 (9.0 kHz)	
	FIL2 (6.0 kHz)	200 Hz to 10 kHz (200 Hz)
	FIL3 (3.0 kHz)	
FM FM-D	FIL1 (15 kHz)	
	FIL2 (10 kHz)	Fixed to the default value
	FIL3 (7.0 kHz)	

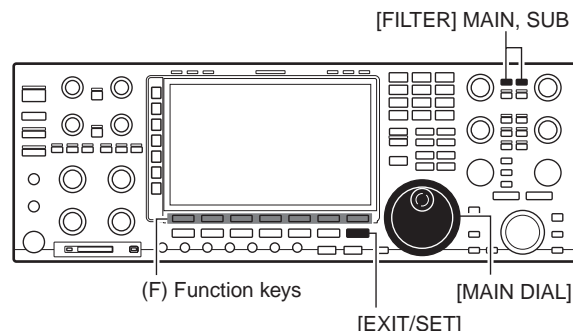

### When selecting “FIL1” (Wide)



### When selecting “FIL2” (Mid)



### When selecting “FIL3” (Narrow)



### While adjusting the passband width



### When selecting the passband width (500 Hz or less)



#### For your reference:

- While holding down [BW](F), rotating [MAIN DIAL] also adjusts the passband width.
- When you set the IF filter to FIL2 or FIL3 in the FM mode, transmission is made in the FM narrow mode.

◇ DSP filter shape

The DSP filter shape for SSB, SSB data and CW can be independently set to soft or sharp.

- ① Hold down [FILTER] for 1 second.
  - The Filter screen is displayed.
- ② Select the SSB, SSB-D1 or CW mode.
- ③ Push [FILTER] several times to set the desired IF filter to FIL1 (Wide), FIL2 (Mid) or FIL3 (Narrow).
- ③ Push [SHAPE](F) several times to set the desired filter shape to soft or sharp.
  - When selecting SSB-D2 or SSB-D3, and the 1.2 kHz roofing filter, you can select the filter shape.
- ④ Push [EXIT•SET].
  - Exits the Filter screen.

▨ The filter shape can be independently set for the Main and Sub bands, only when different modes are set.

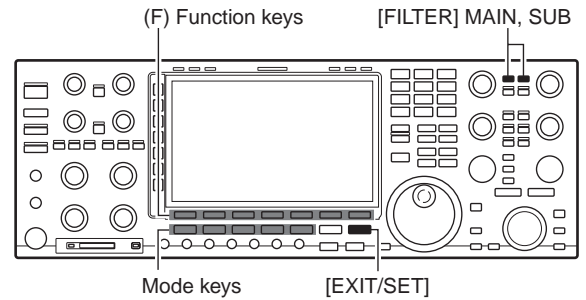

• When selecting “SHARP”



◇ Roofing filter selection

This transceiver has 1.2, 3, 6 and 15 kHz roofing filters for the 1st IF frequency. The roofing filter provides interference reduction from nearby strong signals.

- ➔ Push [ROOFING](F) to set the desired filter width to 1.2, 3, 6, or 15 kHz (default).
  - Hold down [DEF](F) for 1 second to select the default value.

• Roofing filter screen



• Roofing filter default value (kHz)

Mode	FIL1	FIL2	FIL3	Mode	FIL1	FIL2	FIL3
SSB	15	15	6	RTTY	15	6	6
SSB-D	15	6	6	PSK	6	6	6
CW	6	6	6	AM	15	15	15

## ■ IF filter selection (Continued)

### ◇ 1.2 kHz Filter calibration

This transceiver has the 1.2 kHz Optimum Roofing Filter operating at 64 MHz. The characteristic of this Roofing Filter may slightly vary, depending on the operating environment or after long usage. You can adjust it in the Filter calibration mode.

You can automatically or manually adjust the filter.

#### Automatic adjustment

- ① Hold down [FILTER] for 1 second.
  - The Filter screen is displayed.
- ② Select the desired mode.
- ③ Push [ROOFING](F) several times to select '1.2k.'
  - '15k,' '6k,' '3k,' and '1.2k' are selectable.
- ④ Push [ADJ](F).
  - Enters the Filter calibration mode.
- ⑤ Hold down [CAL](F) for 1 second to start the automatic adjustment.
  - "CAL" blinks.
  - When the adjustment is successful, two beeps sound.
  - If the adjustment fails, an error beep sounds.
- ⑥ Push [ADJ](F).
  - Exits the Filter calibration mode.

#### Manual adjustment

- ① Hold down [FILTER] for 1 second.
  - The Filter screen is displayed.
- ② Select the desired mode.
- ③ Push [ROOFING](F) several times to select '1.2k.'
  - '15k,' '6k,' '3k,' and '1.2k' are selectable.
- ④ Push [ADJ](F).
  - Enters the Filter calibration mode.
- ⑤ Rotate [MAIN DIAL] to adjust.
  - The adjustable values are between 0% and 100%. (±1100 Hz of the set value in 5 Hz steps)
  - Adjust the appropriate value so that you can easily hear a desired signal and undesired signals are reduced.
- ⑥ Push [ADJ](F).
  - Exits the Filter calibration mode.

#### • When selecting "1.2 k" Roofing filter



#### • In the Filter calibration mode (Automatic adjustment)

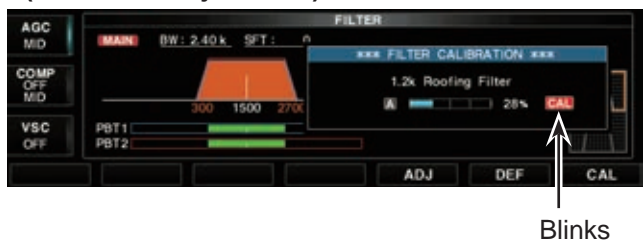

#### • In the Filter calibration mode (Manual adjustment)



## ■ IF filter selection (Continued)

### ◇ Filter shape set mode

The DSP filter shape for SSB, SSB data and CW can be independently set to soft or sharp.

- ① Hold down [SHAPE](F) for 1 second.
  - The Filter shape set screen is displayed.
- ② Push [▲](F) or [▼](F) to select the desired item.
- ③ Rotate [MAIN DIAL] to set the filter shape to soft or sharp.
- ④ Push [EXIT/SET].
  - Exits the Filter shape set screen.

### • Filter shape set screen

		FILTER SHAPE SET	
AGC MID	HF SSB (600Hz - )		SHARP
	SSB-D (600Hz - )		SHARP
	CW ( - 500Hz)		SHARP
COMP OFF MID	50M SSB (600Hz - )		SOFT
	SSB-D (600Hz - )		SHARP
	CW ( - 500Hz)		SHARP
VSC OFF	CW (600Hz - )		SHARP

### HF SSB (600Hz - ) (Default: SHARP)

Select the filter shape for the SSB mode in the HF bands.

Options: SHARP or SOFT

▨ The set filter shape is automatically used only when the IF filter is set to 600 Hz or wider.

### HF SSB-D (600Hz - ) (Default: SHARP)

Select the filter shape for the SSB-D mode in the HF bands.

Options: SHARP or SOFT

▨ The set filter shape is automatically used only when the IF filter is set to 600 Hz or wider.

### HF CW ( - 500Hz) (Default: SHARP)

Select the filter shape for the CW mode in the HF bands.

Options: SHARP or SOFT

▨ The set filter shape is automatically used only when the IF filter is set to 500 Hz or narrower.

### HF CW (600Hz - ) (Default: SHARP)

Select the filter shape for the CW mode in the HF bands.

Options: SHARP or SOFT

▨ The set filter shape is automatically used only when the IF filter is set to 600 Hz or wider.

### 50M SSB (600Hz - ) (Default: SOFT)

Select the filter shape for the SSB mode in the 50 MHz band.

Options: SHARP or SOFT

▨ The set filter shape is automatically used only when the IF filter is set to 600 Hz or wider.

### 50M SSB-D (600Hz - ) (Default: SHARP)

Select the filter shape for the SSB data mode in the 50 MHz band.

Options: SHARP or SOFT

▨ The set filter shape is automatically used only when the IF filter is set to 600 Hz or wider.

### 50M CW ( - 500Hz) (Default: SHARP)

Select the filter shape for the CW mode in the 50 MHz band.

Options: SHARP or SOFT

▨ The set filter shape is automatically used only when the IF filter is set to 500 Hz or narrower.

### 50M CW (600Hz - ) (Default: SHARP)

Select the filter shape for the CW mode in the 50 MHz band.

Options: SHARP or SOFT

▨ The set filter shape is automatically used only when the IF filter is set to 600 Hz or wider.



## Dualwatch operation

Dualwatch simultaneously monitors two frequencies. This transceiver has 2 independent receiver circuits, the Main and Sub bands, so that you can use Dualwatch with no compromises, even on different bands and modes.

- ① Set the desired mode in the Main and Sub bands.
- ② Push [DUALWATCH] to select the Dualwatch operation.
  - To equalize the SUB band frequency and mode to that of the Main band, hold down [DUALWATCH] for 1 second. This Quick Dualwatch function can be turned OFF in the Others set screen. (p. 15-13)  
(SET [F-7] > OTHERS [F-5] > Quick Dualwatch)
- ③ Rotate [MAIN DIAL] or [SUB DIAL] to set the desired frequency.

Normally, the transceiver transmits on the Main band. During Dualwatch operation, you can transmit on the Sub band by doing the following procedures:

- Push [SPLIT] to turn ON the Split function.
- Push [CHANGE] to switch the settings, such as the operating frequency, operating mode, and so on, between the Main and Sub bands.

**NOTE:**

- A beat note may be heard, depending on the frequency combination (3.5 MHz and 7 MHz, and so on).
- Receiver sensitivity may be decreased when the same frequency band and the same antenna are selected during Dualwatch.

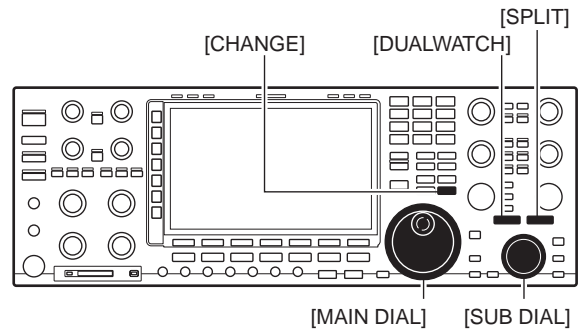

• During the Dualwatch operation



• When the Split function is ON

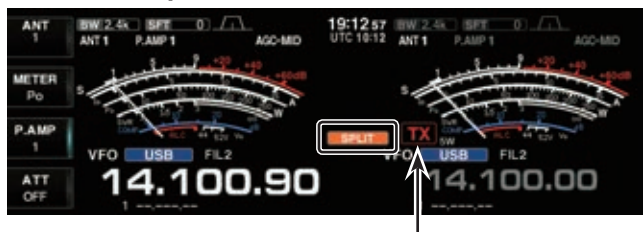

Appears on the SUB band

• When switching the settings between the Main and Sub bands



## ■ Noise blanker

The Noise blanker eliminates pulse-type noise such as the noise from car ignitions.

The Noise blanker cannot be used in the FM mode.

- ① Push [NB] to turn ON the Noise blanker function.
  - [NB] indicator lights.
  - Pushing [NB] toggles the Noise blanker function ON or OFF.
- ② Rotate the [NB] control to adjust the Noise blanker threshold level.
  - The desired signal may be distorted if you rotate the [NB] control to the extreme right.
  - Adjust to the appropriate position, according to the noise level or operating environment.

**NOTE:** When using the Noise blanker, received signals may be distorted if they are excessively strong or the noise type is other than pulse type. In that case, turn the Noise blanker OFF, or rotate the [NB] control to a shallow position.

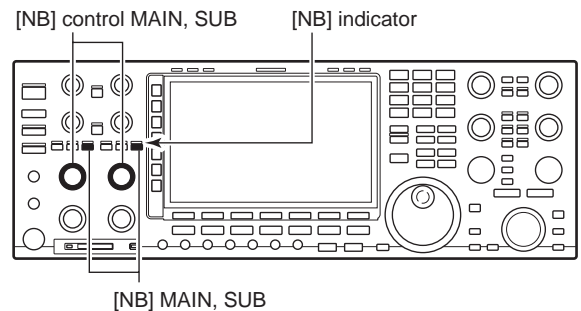

## ◇ NB Set mode

To deal with various type of noise, the attenuation level and noise width can be set in the NB screen.

- ① Hold down [NB] for 1 second.
  - The NB screen is displayed.
- ② Push [▲](F) or [▼](F) to select the desired item.
- ③ Rotate [MAIN DIAL] to set the desired level or value.
  - Hold down [DEF](F) for 1 second to select the default value.
- ④ Push [EXIT/SET].
  - Exits the NB screen.

### • NB screen

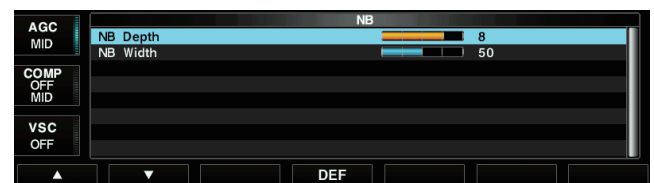

### NB Depth (Default: 8)

Sets the noise attenuation level.  
Level value is between 1 and 10

### NB Width (Default: 50)

Sets the noise pulse width.  
Width value is between 1 and 100



## ■ Noise reduction

The Noise reduction function reduces random noise components and enhances desired signals that are buried in noise. The Noise reduction function uses the DSP circuit.

- ① Push [NR] to turn ON the Noise reduction.
  - [NR] indicator lights.
  - Pushing [NR] toggles the Noise reduction ON or OFF.
- ② Rotate the [NR] control to adjust the Noise reduction level.
  - Rotating the [NR] control to the right increases the reduction level, and rotating to the left decreases it.
  - Set for maximum readability.

/// Too much noise reduction can result in audio signal masking or distortion. Set the [NR] control for maximum readability.

## ■ Digital selector

The Digital selector control manually adjusts the center frequency of the automatic preselector. The automatic preselector adds selectivity ahead of the 1st mixer. This reduces intermodulation distortion from nearby strong signals. The automatic preselector tracks the frequency tuning, changing it's resonant frequency in discrete steps. The Digital selector functions between 1.5 MHz and 29.999999 MHz.

- ① Push [DIGI-SEL] to turn ON the Digital selector.
  - The [DIGI-SEL] indicator lights.
  - Pushing [DIGI-SEL] toggles the Digital selector ON or OFF.
- ② Rotate the [DIGI-SEL] control to adjust the center frequency.

/// **NOTE:**

- When you rotate [MAIN DIAL] (or [SUB DIAL] during Dualwatch or Split function) while the Digital selector is activated, mechanical noise may be heard due to the switching noise from internal relays.
- The preamps (P.AMP 1 or P.AMP 2) cannot be used while the Digital selector is activated.

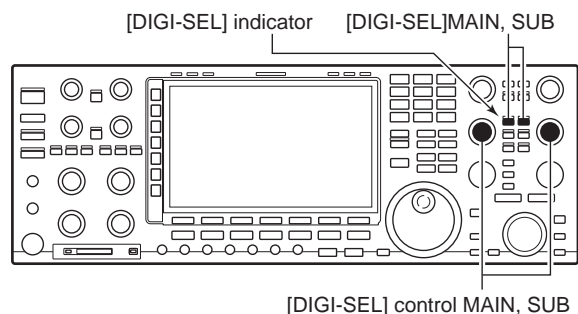
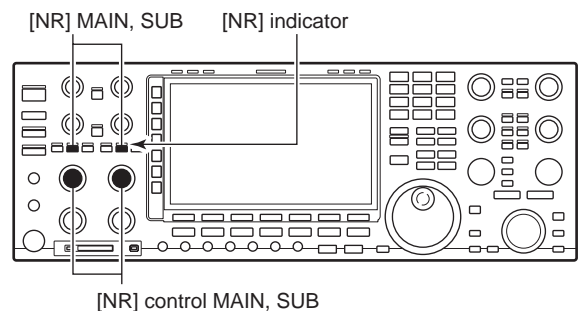

## ■ Notch function

The transceiver has Auto and Manual notch functions.

- Auto notch: Used in the SSB, AM, or FM mode
- Manual notch: Used in the SSB, CW, RTTY, PSK, or AM mode

### ◇ Auto notch function

The Auto notch function uses DSP to automatically attenuates beat tones, tuning signals, and so on, even if they are moving.

- ➔ Push [NOTCH] several times to select "AN."
  - Pushing [NOTCH] toggles the Notch function "AN" (Auto notch), "MN" (Manual notch), and OFF.
  - "AN" is displayed when Auto notch is in use.

### ◇ Manual notch function

The Manual notch can be set to attenuate a frequency by rotating the [NOTCH] control.

- ① Push [NOTCH] several times to select "MN."
  - Pushing [NOTCH] toggles the Notch function "AN" (Auto notch), "MN" (Manual notch), and OFF.
  - "MN" is displayed when manual notch is in use.
  - Hold down [NOTCH] for 1 second to toggle the manual notch filter width between "WIDE," "MID," and "NAR." After selecting, the filter width value is displayed for about 1 second.
- ② Rotate the [NOTCH] control to manually attenuate a frequency.

While tuning the manual notch, noise may be heard. This comes from the DSP unit and does not indicate an equipment malfunction.

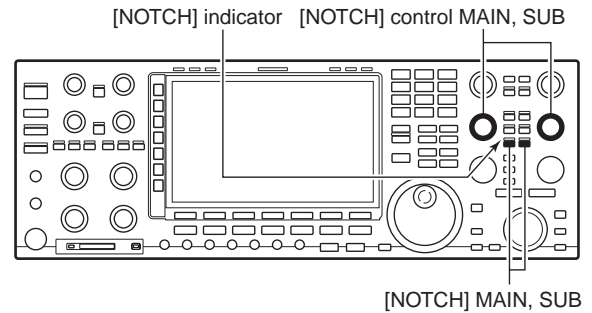

### • The Auto notch indication



### • The Manual notch indication

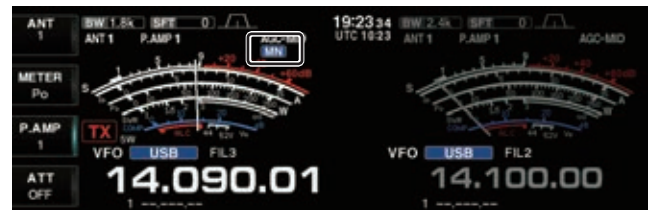

### • When selecting the manual notch filter width



## ■ Auto tuning function

When an off-frequency signal is received, the Auto tuning function tunes the desired signal within a  $\pm 500$  Hz range in the CW mode, or a  $\pm 5$  kHz range in the AM mode. This function is usable only in the CW and AM modes.

➔ Push [AUTO TUNE] to turn ON the Auto tuning function.

- “**AUTOTUNE**” blinks when the Auto tuning function is activated.
- After 2 seconds has passed, the Auto tuning function automatically stops tuning, even it's still off frequency.

### IMPORTANT!

When receiving a weak signal, or receiving a signal with interference, the Auto tuning function may tune the receiver to an undesired signal.

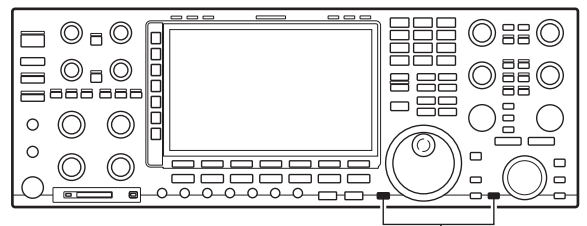

[AUTO TUNE] MAIN, SUB



Blinks

## ■ Main/Sub band tracking function

When you hold down [MAIN] for 1 second to turn ON the Main/Sub band tracking function, the Sub band frequency and mode are equalized to the Main band settings. If you set the Main and Sub bands to the different antennas, you can hear which antenna has better reception. Rotating [MAIN DIAL] changes the Main and Sub frequencies in the same tuning steps at the same time. The direct frequency entry in the Main band also changes the both frequencies together. But rotating [SUB DIAL] changes only the Sub frequency. So, you can change the tracking separation between the Main and Sub band frequencies. Rotating [MAIN DIAL] changes both frequencies, keeping the amount of the frequency separation.

### The Tracking function will be canceled when:

- Starting a scan
- The Sub band frequency is changed by pushing a band key, [V/M] key, direct frequency entry, and so on.

### ◇ Turning ON the Tracking function

① Select the “MAIN/SUB Tracking [MAIN] SW” item in the Others set screen.

**SET [F-7] ↘ OTHERS [F-5] ↘ MAIN/SUB Tracking [MAIN] SW**

② Rotate [MAIN DIAL] to select “ON.”

- The Tracking ON function is assigned to only the [MAIN] key.

③ Push [EXIT/SET] several times.

- Exits the Set screen.

④ Select a desired operating frequency or mode.

⑤ Hold down [MAIN] for 1 second to turn ON the Main/Sub band tracking function.

- “MAIN” or “SUB” blinks blue.
- The Sub band frequency is equalized to the Main band frequency.
- If you want to turn OFF the function, hold down [MAIN] or [SUB] for 1 second.

### • Others set screen

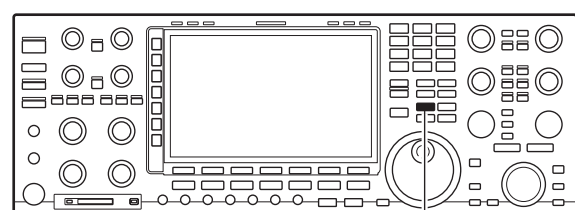
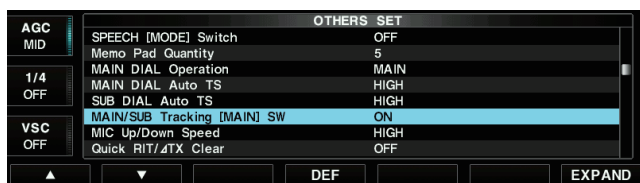

[MAIN]

---

■ About the VOX function .....	8-2
◇ Turning ON the VOX function .....	8-2
◇ Adjusting the VOX function .....	8-2
◇ VOX set mode .....	8-3
■ About the Break-in function .....	8-4
◇ Semi break-in operation .....	8-4
◇ Full break-in operation .....	8-4
■ About the ΔTX function .....	8-5
◇ ΔTX monitor function .....	8-5
■ About the Monitor function .....	8-5
■ Setting the speech compressor (SSB only) .....	8-6
■ Setting the transmit filter width (SSB/SSB-D only) .....	8-6
■ Split frequency operation .....	8-7
■ About the Quick split function .....	8-8
◇ Split lock function .....	8-8

## ■ About the VOX function

The VOX (Voice-Operated Transmission) function switches between transmit and receive with your voice. This function provides hands-free operation.

### ◇ Turning ON the VOX function

- ① Push the Mode key to select a phone mode (SSB, AM, FM).
- ② Push [VOX/BK-IN].
  - "VOX" is displayed and the VOX function is turned ON.
  - The [VOX/BK-IN] indicator above this key lights white.

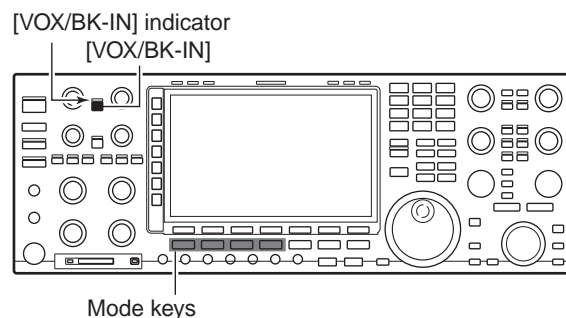

### ◇ Adjusting the VOX function

- ① Push the Mode key to select a phone mode (SSB, AM, FM).
- ② Push [VOX/BK-IN].
  - "VOX" is displayed and the VOX function is turned ON.
  - The [VOX/BK-IN] indicator above this key lights white.
- ③ While speaking into the microphone at your normal voice level, rotate [VOX GAIN] to the point where the transceiver continuously transmits.
  - Higher values make the VOX function more sensitive to your voice.
- ④ While receiving, rotate [ANTI VOX] to the point where the transceiver does not switch to transmit due to sound from the speaker or other sources.
  - Higher values make the VOX function less sensitive to sound from the speaker or other sources.
- ⑤ Adjust the VOX delay and the VOX voice delay in the VOX set screen, if necessary.

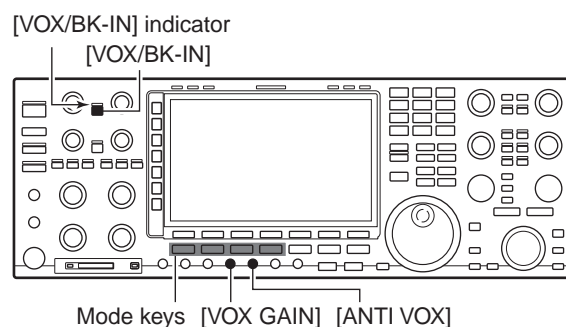

◇ **VOX set mode**

- ① Hold down [VOX/BK-IN] for 1 second.
  - The VOX set screen is displayed.
- ② Select the desired item using by pushing [▲](F) or [▼](F).
- ③ Rotate [MAIN DIAL] to the desired value or level.
  - Hold down [DEF](F) for 1 second to select a default value.
- ④ Push [EXIT/SET].
  - Exits the Set screen.

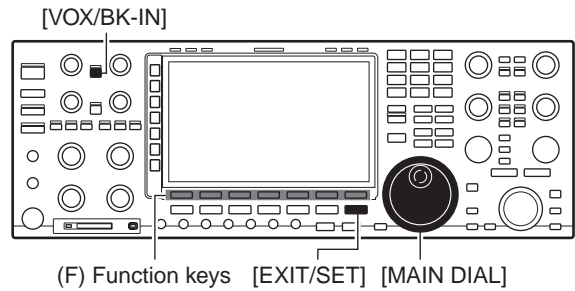

• **VOX delay**

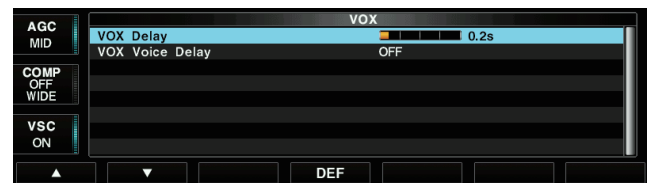

• **VOX voice delay**



**VOX Delay** (Default: 0.2s)

Set the VOX delay to between 0 and 2.0 seconds, for a convenient interval before returning to receive.

**VOX Voice Delay** (Default: OFF)

Set the VOX voice delay to prevent interruption of your voice when switching to transmit. You can select Short, Mid, Long and OFF.

When using the VOX voice delay, turn the TX monitor function OFF or the transmitted audio will echo.



## ■ About the Break-in function

The break-in function is used in the CW mode to automatically toggle the transceiver between transmit and receive when keying. The transceiver is capable of full break-in or semi break-in.

### ◇ Semi break-in operation

In the semi break-in mode, the transceiver transmits when keying, then automatically returns to receive after a preset time after you stop keying.

- ① Push the Mode key [CW] to select the CW or CW-R mode.
- ② Push [VOX/BK-IN] several times to turn the semi break-in function ON.
  - "BK IN" is displayed.
- ③ Rotate [DELAY] to set the break-in delay time (the delay from transmit to receive).

▨ When using a paddle, rotate [KEY SPEED] to adjust the keying speed.

### ◇ Full break-in operation

In the full break-in mode, the transceiver automatically transmits while keying down and returns to receive immediately after you key up.

- ① Push the Mode key [CW] to select the CW or CW-R mode.
- ② Push [VOX/BK-IN] several times to turn the full break-in function ON.
  - "F-BK IN" is displayed.

▨ • When using a paddle, rotate [KEY SPEED] to adjust the keying speed.  
 • In the full break-in mode, the transceiver automatically returns to receive without a preset break-in delay time after you stop keying. And the transceiver receives while keying up.

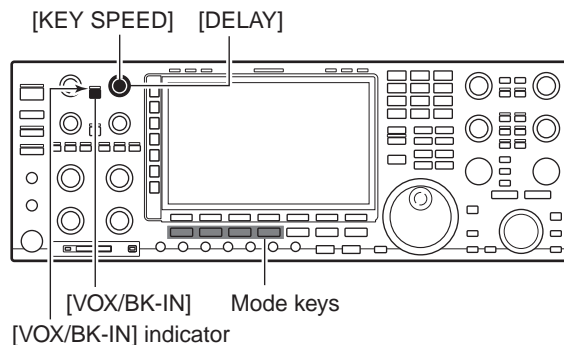

### • Semi break-in ON



### • Full break-in ON



## ■ About the $\Delta$ TX function

The  $\Delta$ TX function shifts the transmit frequency up to  $\pm 9.999$  kHz in 1 Hz steps (10 Hz steps when the 1 Hz step readout is not visible) without shifting the receive frequency.

- ① Push [ $\Delta$ TX].
  - “ $\Delta$ TX” is displayed.
- ② Rotate [RIT/ $\Delta$ TX].
- ③ To reset the  $\Delta$ TX frequency, hold down [CLEAR] for 1 second.
  - If the Quick RIT/ $\Delta$ TX clear function is ON, push [CLEAR] to reset the RIT frequency. (p. 15-15)
- ④ To cancel the  $\Delta$ TX function, push [ $\Delta$ TX] again.
  - “ $\Delta$ TX” disappears.

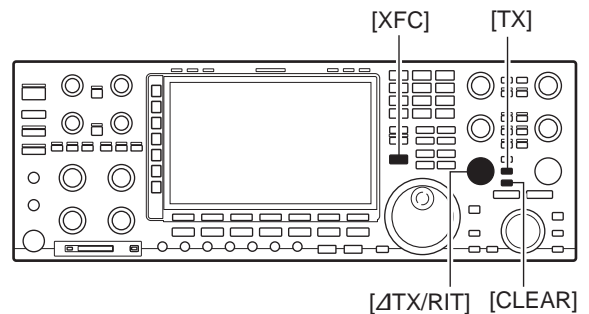

### • $\Delta$ TX function ON

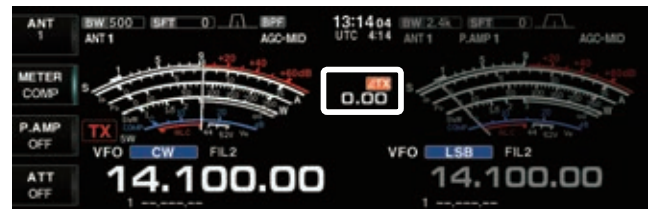

### ◇ $\Delta$ TX monitor function

When the  $\Delta$ TX function is ON, holding down [XFC] allows you to directly monitor the transmit frequency.

#### ✓ For your convenience — Calculate function

The shift frequency of the  $\Delta$ TX function can be added to or subtracted from the displayed frequency.

- ➔ While displaying the  $\Delta$ TX shift frequency, hold down [ $\Delta$ TX] for 1 second.

## ■ About the Monitor function

The Monitor function allows you to monitor your transmit signals in any mode. Use this to check voice characteristics while adjusting transmit audio parameters. (p. 15-4) The CW sidetone functions regardless of the [MONI] key setting.

- ① Push [MONI].
  - The Monitor function is turned ON.
  - [MONI] indicator above this key lights white.
- ② Rotate [MONI GAIN] for the clearest audio output while holding down [PTT] and speaking into the microphone at your normal voice level.

**NOTE:** When using the VOX voice delay (p. 8-3), turn the TX monitor function OFF or the transmitted audio will echo.

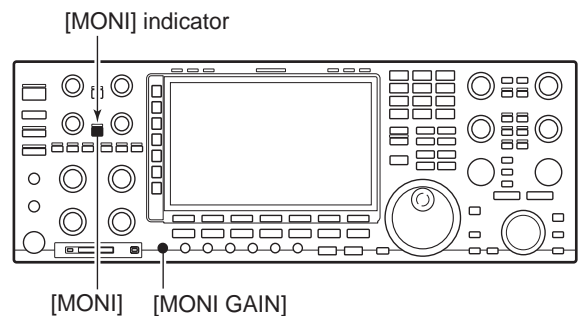

## ■ Setting the speech compressor (SSB only)

The speech compressor increases average RF output power, improving readability at the receiving station, in only the SSB mode.

- ① Push the Mode key [SSB] to select the USB or LSB mode.
- ② Push the Multi function [METER](▶) key several times to select the ALC meter.
- ③ Rotate [MIC] to adjust the microphone gain to a suitable level.
- ④ Push the Multi function [COMP](▶) key. The Speech compressor is turned ON.
- ⑤ Push [METER](▶) several times to select the COMP meter.
- ④ While speaking into the microphone at your normal voice level, rotate the [COMP] control, so that the COMP meter reads within the COMP zone (10 to 20 dB range), as shown to the right.
- ⚡ When the COMP meter peaks exceed the COMP zone, your transmitted voice may be distorted.
- ⑤ Push [METER](▶) several times to select the ALC meter.
- ⑥ While speaking into the microphone at your normal voice level, rotate the [DRIVE] control, so that the ALC meter reads within the 30 to 50% range of the ALC zone, as shown to the right.

### ✓ For your convenience

Hold down [METER](▶) for 1 second to display the multi-function meter to check the ALC and COMP level at a glance.

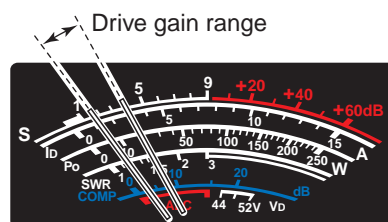
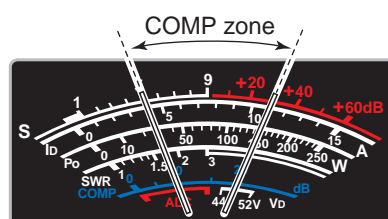
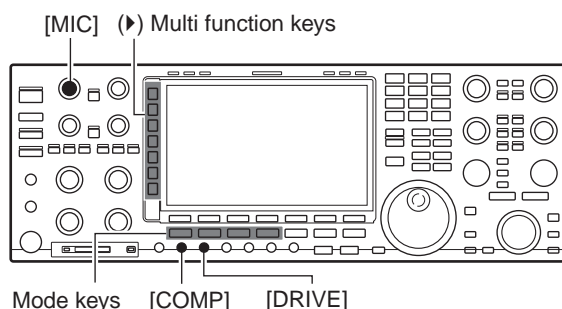

## ■ Setting the transmit filter width (SSB/SSB-D only)

The transmit filter width for the SSB and SSB-D modes can be set. Only the SSB mode can be set to wide, mid and narrow.

- ① Push the Mode key [SSB] to select the USB or LSB mode.
    - While in the SSB mode, push [DATA] to select the SSB-D mode (USB-D or LSB-D).
  - ② Operating in the SSB mode, hold down [COMP](▶) for 1 second several times to set the desired transmit filter width to Wide, Mid, or Narrow.
    - The filter functions regardless of the speech compressor use.
    - The following filters are specified as the default. Each of the filter width can be reset in the Level set mode. (p. 15-5)
- SSB mode WIDE: 100 Hz ~ 2.9 kHz  
 MID: 300 Hz ~ 2.7 kHz  
 NAR: 500 Hz ~ 2.5 kHz
- SSB-D mode: 300 Hz ~ 2.7 kHz

(▶) Multi function keys

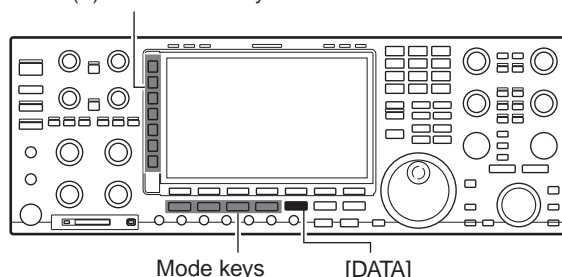

### • Level set screen

		LEVEL SET		
AGC	MID	Tone (Treble)	100	2900
COMP	OFF	SSB TBW (WIDE)	300	2700
		(MID)	500	2500
		(NAR)	300	2700
VSC	OFF	Speech Level		50%
		Side Tone Level		50%
		Side Tone Level Limit	ON	

## ■ Split frequency operation

Split frequency operation allows you to transmit and receive in the same mode on two different frequencies. Split frequency operation uses one frequency on the Main band and another on the Sub band.

The following is an example of using 21.290 MHz for receiving and 21.310 MHz for transmitting.

- ① Set 21.290 MHz (USB) in the Main band.
- ② Push [SPLIT] momentarily, then hold down [M=S] for 1 second.
  - The Quick split function is much more convenient for selecting the transmit frequency. See page 8-8 for details.
  - The equalized frequencies and “**SPLIT**” are displayed.
  - The [SPLIT] indicator lights white.
  - The “**TX**” icon indicates the transmit frequency.
- Set the transmit frequency to 21.310 MHz in one of following ways.
  - ➔ Rotate [MAIN DIAL] while holding down [XFC].
  - ➔ Rotate the [SUB DIAL].
    - The transmit frequency can be monitored while holding down [XFC] or using Dualwatch.
- ④ Now you can receive on 21.290 MHz and transmit on 21.310 MHz.

To reverse the transmit and receive frequencies, push [CHANGE] to exchange the Main and Sub band frequencies.

### ✓ CONVENIENT

#### • Direct shift frequency input

The shift frequency can be directly entered.

- ① Push [F-INP].
  - ② Enter the desired shift frequency by pushing [0] to [9].
    - 0.001 MHz (1 kHz) ~ 9.999 MHz can be set.
    - To enter a minus shift direction, first push [•].
  - ③ Push [SPLIT].
    - The shift frequency is entered in the Sub band and the Split function is turned ON.
- [Example]
- To transmit on a 1 kHz higher frequency:
- Push [F-INP], [1], and then push [SPLIT].
- To transmit on a 3 kHz lower frequency:
- Push [F-INP], [•], [3], and then push [SPLIT].

#### • Split lock function

Accidentally releasing [XFC] while rotating [MAIN DIAL] changes the receive frequency. To prevent this, use both the Split lock and Dial lock functions to change only the transmit frequency. The Split lock function disables the Dial lock function while holding down [XFC] in the Split mode.

The Dial lock's action in the Split mode can be selected in the Others set screen for both the receive and transmit frequencies, or only the receive frequency. (p. 15-14)

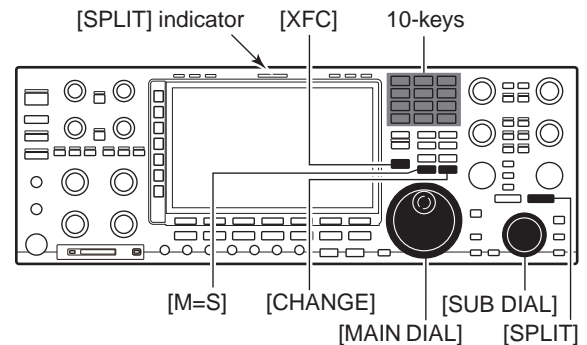

#### • When the Split function ON



#### • When [XFC] is pushed



#### • You are ready for Split frequency operation





## ■ About the Quick split function

When you find a DX station, an important consideration is how to set the split frequency.

When you hold down [SPLIT] for 1 second, the Split frequency function is turned ON, the Sub band frequency is equalized to the Main band frequency, and it becomes the initial transmit frequency.

This shortens the time needed to start the Split frequency operation.

The Quick split function is ON by default. For your convenience, it can be turned OFF in the Others set screen (p. 15-13). In that case, [SPLIT] does not equalize the Main and Sub band frequencies.

- Suppose you are operating at 21.290 MHz (USB) in the VFO mode.
- ① Hold down [SPLIT] for 1 second.
  - The Split frequency operation is turned ON.
  - The Sub band frequency is equalized with the Main band frequency.
  - “**F-INP**” is displayed and the Sub band readout becomes the initial transmit frequency.
- ② Enter the desired offset frequency from the keypad and then push [SPLIT], or set the transmit frequency by rotating [MAIN DIAL] while pushing [XFC], or by rotating [SUB DIAL].
  - “**F-INP**” disappears when [XFC] is pushed, or [MAIN DIAL] or [SUB DIAL] is rotated.
  - Set the offset frequency by pushing [0] to [9]
    - [Example]
    - To transmit on a 1 kHz higher frequency:
      - Push [F-INP], [1] and then push [SPLIT].
    - To transmit on a 3 kHz lower frequency:
      - Push [F-INP], [\*,] [3] and then push [SPLIT].

### ◇ Split lock function

The Split lock function is convenient for changing only the transmit frequency. When the Split lock function is not used, accidentally releasing [XFC] while rotating [MAIN DIAL] changes the receive frequency. The Split lock function is ON by default, but can be turned OFF in the Others set screen. (p. 15-14)

- ① In the Split mode, push [LOCK] for both the Main and Sub bands to activate the Split lock function.
- ② While pushing [XFC], rotate [MAIN DIAL] to change the transmit frequency.
  - If you accidentally release [XFC] while rotating [MAIN DIAL], the receive frequency does NOT change.

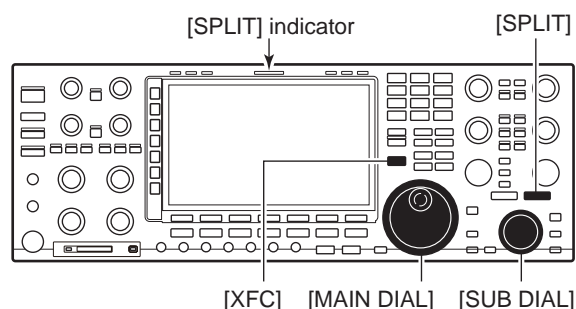

#### • When the Quick split function ON



#### • When [XFC] is pushed

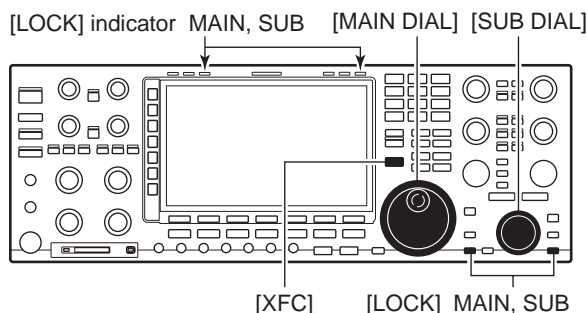

---

■ Recording function .....	9-2
■ Recording a QSO .....	9-3
◇ Quick recording .....	9-3
◇ Basic recording .....	9-3
■ Playing back the recorded audio (QSO).....	9-4
■ Operating while playing back .....	9-5
■ Deleting a recorded audio file .....	9-6
■ Deleting a recorded audio folder .....	9-6
■ Instant replay function .....	9-7
■ Recording the communication audio .....	9-8
■ Playing back the recorded audio .....	9-8
■ Recording or playing back a TX message .....	9-9
◇ Recording .....	9-9
◇ Playing back .....	9-9
◇ Programming a TX message name .....	9-10
■ Transmitting a recorded message .....	9-11
◇ Single TX.....	9-11
◇ Repeat TX .....	9-11
◇ Setting the transmit level .....	9-12
■ Voice Set mode .....	9-13
■ Saving a voice memory onto an SD card or USB flash drive .....	9-14



## Recording function

This transceiver has two recording functions, QSO REC and Instant Replay functions.

The difference between these two functions is described in the table to the right.

Refer to the pages written in the table for details on each functions.

**For your reference:**

To record the TX audio, use the TX voice memory. (p. 9-9)

	QSO REC	Instant Replay
<b>Reference</b>	p. 9-3	p. 9-7
<b>Recording</b>	Records the QSO audio while operating the transceiver. • Also records the CW audio.	Records the audio contents of the previous 15 seconds before [REC] is pushed. • Also stores the CW sound.
<b>Purpose</b>	To start recording	To recheck the contents
<b>Recording location</b>	SD card/USB flash drive	Built-in memory
<b>Starting method</b>	Hold down [REC], or push [QSO REC]	Push [REC]
<b>Stopping method</b>	Hold down [REC], or push [QSO REC]	Push [REC]
<b>Capacity</b>	Differs, depending on the external memory	1 content (15 seconds: default)
<b>Display while recording</b>	"●" appears	None
<b>To playback</b>	Push [QSO PLAY]	Push or hold down [PLAY]
<b>Display while playing back</b>	The Voice QSO player screen	"▶PLAY" appears

The "QSO REC" and "Instant replay" recording contents

**QSO REC function**

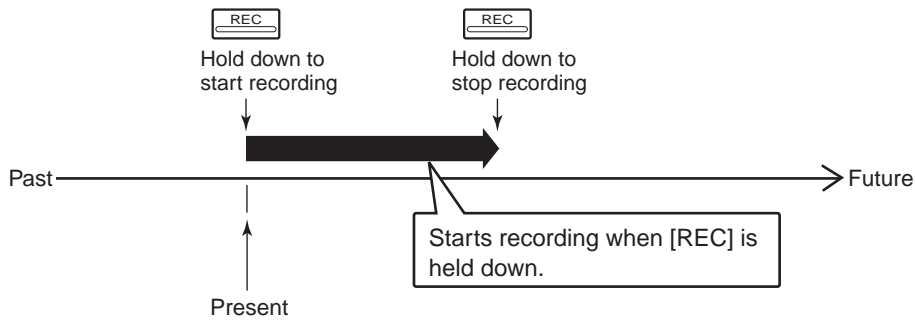

**Instant replay function**

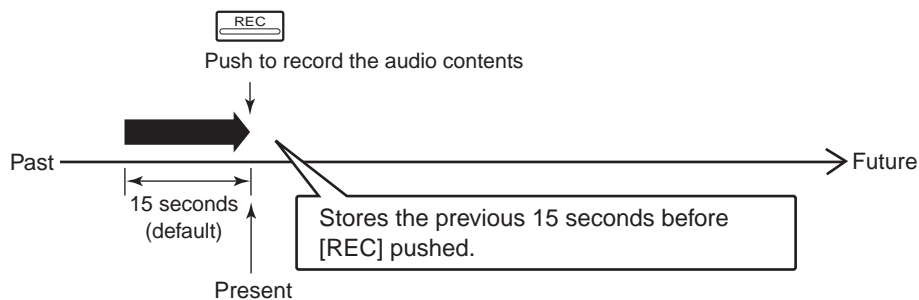

## ■ Recording a QSO

This transceiver consists with a QSO recorder not only for the received audio, but also for the transmitted audio.

You can record a DX'pedition news, contests and so on, or your communication contents. The recorded contents can be saved onto an SD card or USB flash drive.

There are two ways to record the communication.

**NOTE:**

- To record a QSO, an SD card or USB flash drive is required. (pp. 3-5, 3-6)
- DO NOT insert the SD card or USB flash drive while recording a QSO. The recording may be interrupted.
- After the recording starts, it continues, even if the transceiver is turned OFF and ON again.

### ◇ Quick recording

You can quickly record received audio.

- ➔ Hold down [REC] for 1 second to start audio recording.
  - “●” appears while recording.
  - Hold down [REC] for 1 second again to stop recording.
  - Push [REC] to record last 15 seconds before pushing [REC].

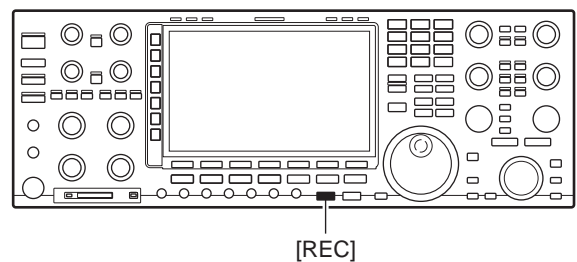

### ◇ Basic recording

You can record both received and transmitted audio.

- The Multi-function screens are OFF.
- ① Push [VOICE](F).
  - The Voice memory screen is displayed.
- ② Hold down [QSO REC](F) for 1 second to start voice recording.
  - “●” appears while recording.
  - “||” appears while recording is paused.
  - Recording is continuous until the memory device becomes full.
  - If the recording file's content reaches 2GB, the transceiver automatically creates a new file, and continues recording.
- ③ Hold down [QSO REC](F) for 1 second to stop recording.
  - “●” disappears.
- ④ Push [EXIT/SET].
  - Exits the Voice memory screen.

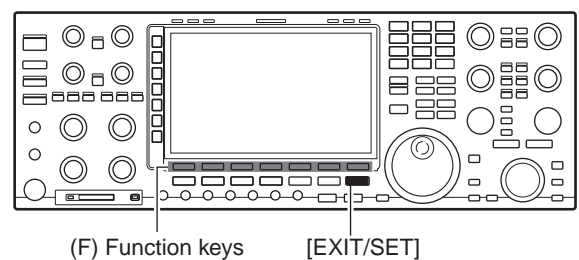

### • While recording

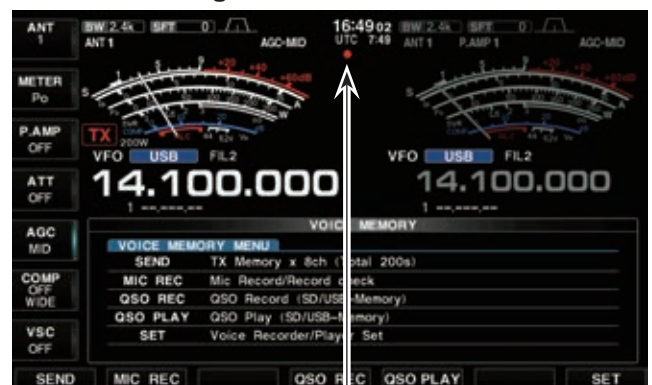

Appears

### ✓ Convenient!

When the PTT Automatic Recording function is set to ON in the Voice set mode, the recording automatically starts when you push [PTT]. (p. 9-14)

## ■ Playing back the recorded audio (QSO)

You can playback the recorded QSO audio.

- The Multi-function screens are OFF.
- ① Push [VOICE](F).
  - The Voice memory screen is displayed.
- ② Push [QSO PLAY](F).
  - The Voice QSO player screen is displayed.
  - The folder list is displayed.
  - The folder name is formatted yyyyymmdd (yyyy: year, mm: month, dd: day).
- ③ Push [▲](F) or [▼](F) to select the folder that contains the file you want to playback.
  - Rotating [MAIN DIAL] also selects the folder.
- ④ Push [FILE](F).
  - The file list is displayed.
  - The file name is formatted yyyy-mm-dd hh:mm:ss (yyyy: year, mm: month, dd: day, hh: hour, mm: minute, ss: second).
- ⑤ Push [▲](F) or [▼](F) to select the file that you want to playback.
  - Rotating [MAIN DIAL] also selects the file.
- ⑥ Push [PLAY](F) to start playback.
  - Playback continues to the next file, and it is stopped when the last file in the folder is played back.
- ⑦ Push [EXIT/SET] several times.
  - Exits the Voice memory screen.

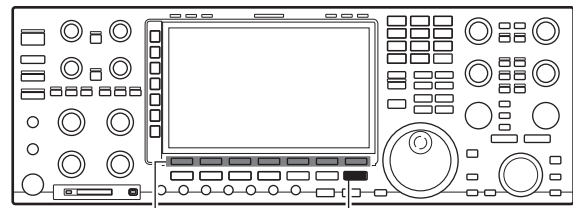

(F) Function keys [EXIT/SET]

File list

Folder

ID	DATE	TIME	FREQ	MODE	DIRECTION	DURATION
20141017	2014-10-17	17:07:05	14.100.00	USB	RX	0:06
2014-10-17	2014-10-17	17:07:23	14.100.00	USB	RX	0:15
2014-10-17	2014-10-17	17:11:55	14.198.40	USB	RX	0:17
2014-10-17	2014-10-17	17:12:25	14.100.00	USB	RX	0:16

**Progress bar**  
Displays the playback progress bar.

**Total time**  
Shows the file's total playback time.

**Played back time**  
Shows the played back time.

**Playback mark**  
Appears while the audio is playing back.  
• The mark disappears while pausing.

## ■ Operating while playing back

You can fast forward or rewind while playing back.

### • Fast forward while playing

Push [▶▶](F) to fast forward to the skip time point.  
 (Default: 10 seconds)  
 You can change the skip time in the Voice Set mode.  
 (p. 9-14)

**VOICE [F-2] ▾ SET [F-7] ▾ QSO PLAY Skip Time**

### • Rewind while playing

Push [◀◀](F) to rewind to the skip time point.  
 (Default: 10 seconds)  
 You can change the skip time in the Voice Set mode.  
 (p. 9-14)

**VOICE [F-2] ▾ SET [F-7] ▾ QSO PLAY Skip Time**

- If you push [◀◀](F) within the first one second of the file, the skip time at the end of the previously recorded file will play back.

### • Pause while playing

Push [▶||](F) to pause.  
 • Push [▶||](F) again to resume.

### • Playing the previous file

Push [◀◀](F) to play the previous file.  
 • In case there are other files in the folder, while the oldest file is playing back, push [◀◀](F) to start playing the beginning of the file.

### • Playing the next file

Push [▶▶](F) to play the next file.  
 • In case there are other files in the folder, while the most recent file is playing back, push [▶▶](F) to stop the playback.

### • Moving to the beginning of the previous file

When the playback is paused anywhere within the file, push [◀◀](F) one or more times to return to the beginning of the file, and pause.  
 • Push [▶||](F) to playback.

When the playback is paused at beginning of a file, push [◀◀](F) to move to the beginning of the previous file, and pause.  
 • Push [▶||](F) to playback.

### • Moving to the beginning of the next file

When the playback is paused, push [▶▶](F) to move to the beginning of the next file, and pause.  
 • Push [▶||](F) to playback.

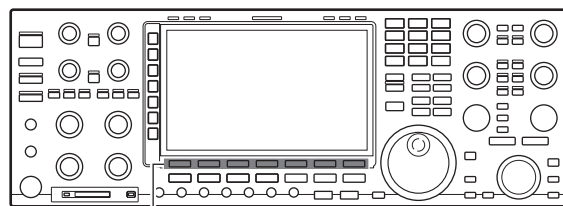

(F) Function keys

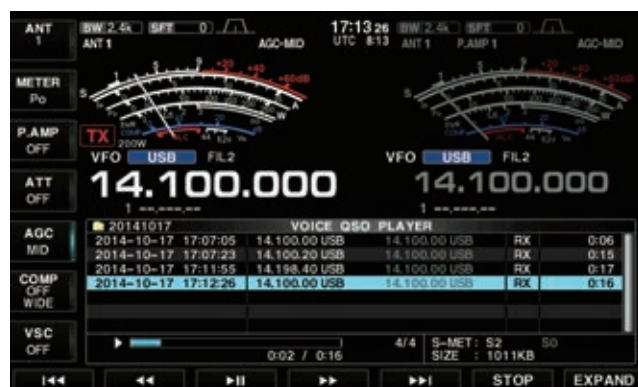

◀◀ (Play the previous file)      ▶|| (Pause or play)      ▶▶ (Play the next file)  
 ◀◀ (Rewind)      ▶|| (Pause or play)      ▶▶ (Forward)      STOP (Stop playing)

**For your reference:**

- Holding down a key repeats the action until it is released (other than the [▶||](F) key).  
 Example: Hold down [▶▶](F) to repeat skipping 10 seconds until you release the [▶▶](F) key. (Default: 10 seconds)
- You can fast forward or rewind the file that is playing by rotating [MAIN DIAL]. The fast forward/rewind time is one twentieth of the total file time, regardless of the skip time setting.

## ■ Deleting a recorded audio file

You can delete the recorded audio file.

- The Multi-function screens are OFF.
- ① Push [VOICE](F).
  - The Voice memory screen is displayed.
- ② Push [QSO PLAY](F).
  - The Voice QSO player screen is displayed.
  - The folder list is displayed.
  - The folder name is formatted yyyyymmdd (yyyy: year, mm: month, dd: day).
- ③ Push [▲](F) or [▼](F) to select the folder that contains the file you want to delete.
  - Rotating [MAIN DIAL] also selects the folder.
- ④ Push [FILE](F).
  - The file list is displayed.
  - The file name is formatted yyyy-mm-dd hh:mm:ss (yyyy: year, mm: month, dd: day, hh: hour, mm: minute, ss: second).
- ⑤ Push [▲](F) or [▼](F) to select the file that you want to delete.
  - Rotating [MAIN DIAL] also selects the file.
- ⑥ Hold down [DEL](F) for 1 second.
  - Opens the confirmation window "Are you sure?."
- ⑦ Push [OK](F).
  - The selected file is deleted.
  - Push [EXIT/SET] to cancel deleting.
- ⑧ Push [EXIT/SET] several times.
  - Exits the Voice memory screen.

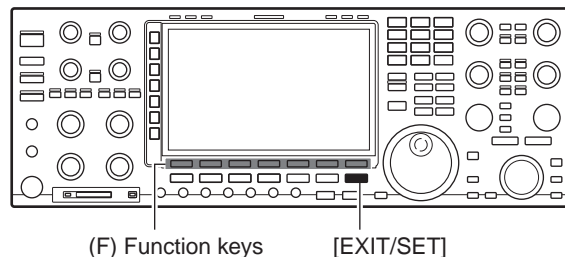

### • The confirmation window



## ■ Deleting a recorded audio folder

You can delete the recorded audio folder.

- The Multi-function screens are OFF.
- ① Push [VOICE](F).
  - The Voice memory screen is displayed.
- ② Push [QSO PLAY](F).
  - The Voice QSO player screen is displayed.
  - The folder list is displayed.
  - The folder name is formatted yyyyymmdd (yyyy: year, mm: month, dd: day).
- ③ Push [▲](F) or [▼](F) to select the folder that you want to delete.
  - Rotating [MAIN DIAL] also selects the folder.
- ④ Hold down [DEL](F) for 1 second.
  - Opens the confirmation window "Are you sure?."
- ⑤ Push [OK](F).
  - The selected folder is deleted.
  - Push [EXIT/SET] to cancel deleting.
- ⑥ Push [EXIT/SET] several times.
  - Exits the Voice memory screen.

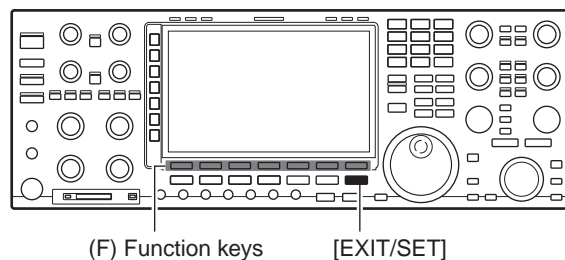

### • The confirmation window

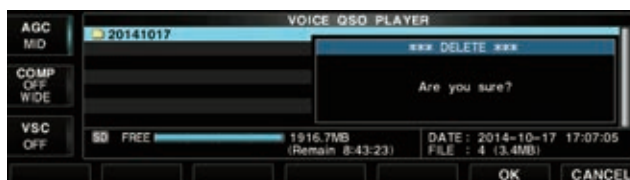

# Instant Replay function

The Instant Replay function records the previous 15 seconds. This function is convenient for checking misheard audio.

The audio is recorded into the built-in memory when [REC] is pushed. Only one record can be stored, and it is overwritten when [REC] is pushed again.

You can change the recording time up to 30 seconds in the Voice set screen.

## Recording and playing the communication audio

### Pushing [REC]

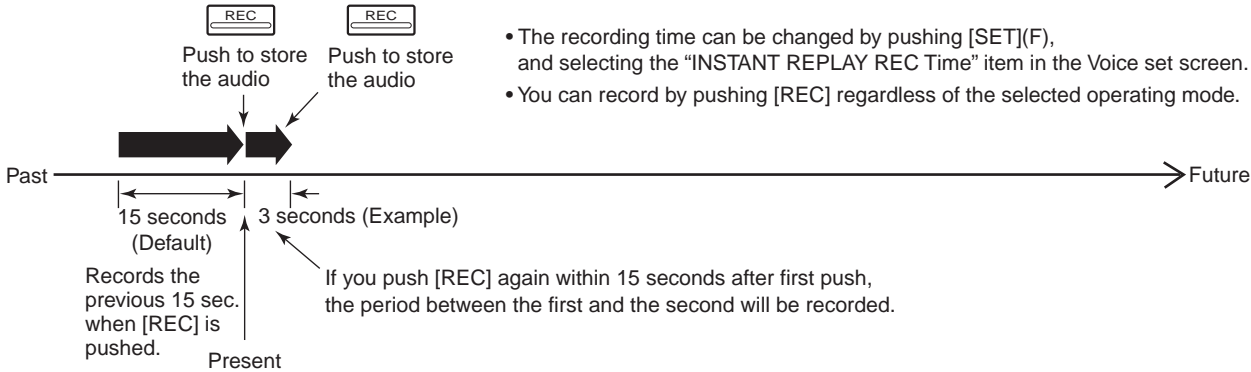

### Playing all record

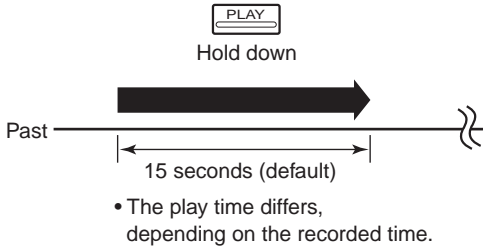

### Playing last 5 seconds

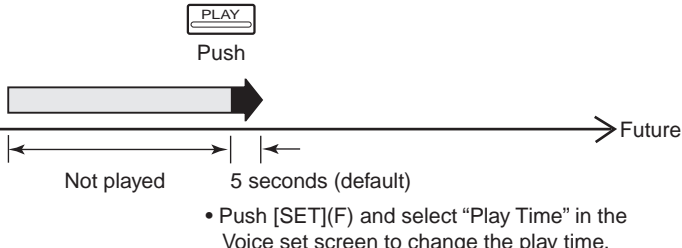



## Recording the communication audio

➤ Push [REC].

- Records the previous 15 seconds when [REC] is pushed.
- You can change the recording time on the Voice set screen as described on page 9-14. (Default: 15 seconds)

**VOICE [F-2] ▾ SET [F-7] ▾ INSTANT REPLAY REC Time**

- The audio is recorded in the built-in memory.

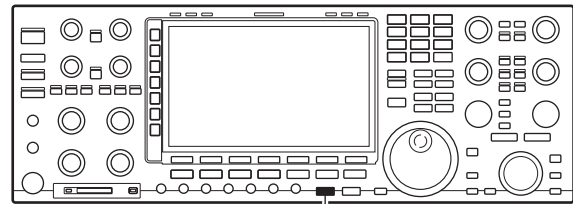

[REC]

**For your reference:**

If you transmit while recording for the Instant replay function, the TX voice is recorded.

## Playing back the recorded audio

You can playback the recorded audio.

➤ Hold down [PLAY] for 1 second.

- Starts to playback all of the recorded audio. (default: 15 second)

➤ Push [PLAY].

- Starts to playback the recorded audio for preset time period (default: 5 seconds). (p. 9-14)

**VOICE [F-2] ▾ SET [F-7] ▾ Play Time**

- “▶PLAY” appears while playing back.

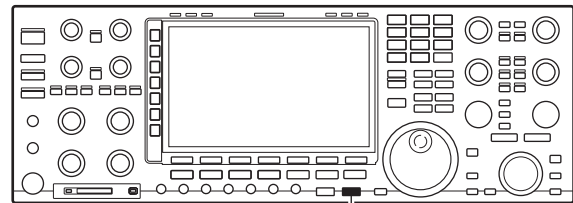

[PLAY]

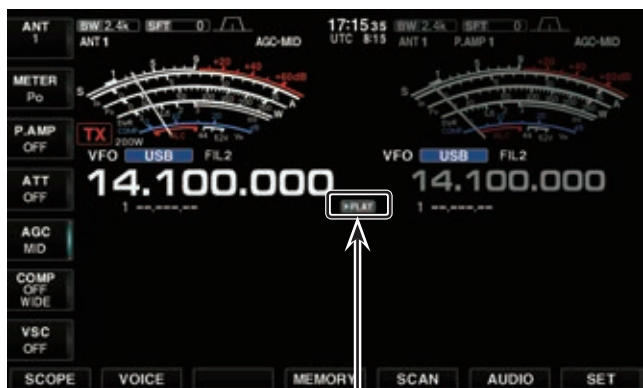

Appears

## Recording or playing back a TX message

To transmit a message using the Voice memory, first record the desired message as described below. You can record up to 8 digital voice messages of up to 200 seconds each, for transmission.

### Recording

- The Multi-function screens are OFF.
- ① Push [VOICE](F).
  - The Voice memory screen is displayed.
- ② Push [MIC REC](F).
  - The Voice MIC-Record screen is displayed.
- ③ Push [▲](F) or [▼](F) to select the desired Voice memory channel “T1” to “T8.”
- ④ Hold down [REC](F) for 1 second to start recording.
  - “**REC**” appears.
- ⑤ Speak into the microphone without holding down [PTT].
  - While speaking into the microphone at your normal voice level, adjust the [MIC] control so that the “MIC-REC LEVEL” meter reads 100%.
  - While recording, the timer counts up the remaining time period. You can record up to 200 seconds that is total of “T1” to “T8” voice memories.
  - Previously recorded contents are overwritten.
- ⑥ Push [REC](F) to stop recording.
- ⑦ Push [EXIT/SET] several times.
  - Exits the Voice memory screen.

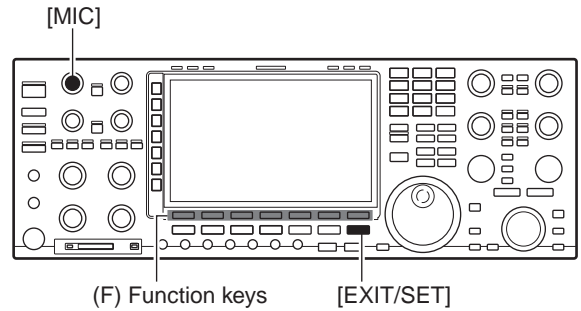

### • While recording

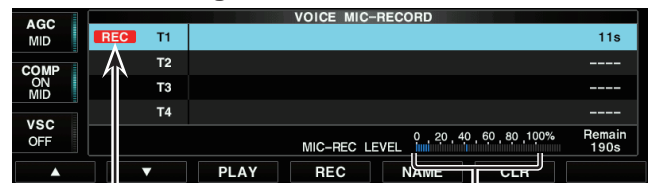

Appears Adjust [MIC] control so that this indicator reads 100%.

### Playing back

- ① Do the steps ① and ② as described above to display the Voice MIC-Record screen.
- ② Push [▲](F) or [▼](F) to select the desired Voice memory channel “T1” to “T8” to playback.
- ③ Push [PLAY](F) to start playback.
  - “**PLAY**” appears and the timer counts down.
  - Playback is automatically terminated when all of the recorded contents in the channel are played back.
  - To pause while playing back, push [▲](F), [▼](F), [PLAY](F), [REC](F), [NAME](F), [CLR](F), or [EXIT/SET].
  - To clear the recorded contents of the selected Voice memory channel, hold down [CLR](F) for 1 second.
- ④ Push [EXIT/SET] several times.
  - Exits the Voice MIC-Record screen.

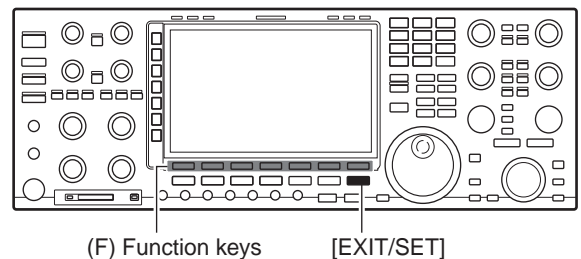

### • While playing back

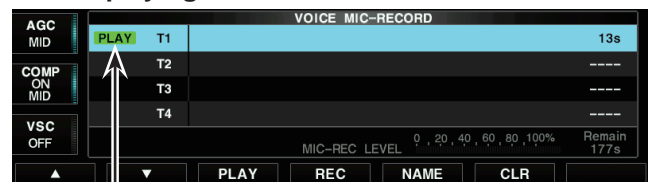

Appears

## 9 VOICE RECORDER FUNCTIONS

### ■ Recording or playing back a TX message (Continued)

#### ◇ Programming a TX message name

You can enter alphanumeric names of up to 30 characters each for the recorded message.

Example: Entering a TX message name 'CQ JA3YUA' to the Voice memory channel T1.

○ The Multi-function screens are OFF.

- ① Push [VOICE](F).
  - The Voice memory screen is displayed.
- ② Push [MIC REC](F).
  - The Voice MIC-Record screen is displayed.
- ③ Push [NAME](F).
  - Enters the name entry mode.
- ④ Push [T1..T8](F) several times to select the Voice memory channel "T1."
  - You cannot select a Voice memory channel that has no recorded audio.

⑤ Enter a desired TX message name.

- ① When [ABC](▶) is selected, rotate [MAIN DIAL] to select "C."
- ② Push [▶](F) to move the cursor.
- ③ Rotate [MAIN DIAL] to select "Q."
- ④ Push [▶](F) to move the cursor.
- ⑤ Push [SPACE](F) to enter a space.
- ⑥ Rotate [MAIN DIAL] to select "J."
- ⑦ Push [▶](F) to move the cursor.
- ⑧ Rotate [MAIN DIAL] to select "A."
- ⑨ Push [123](▶), and then rotate [MAIN DIAL] to select "3."
- ⑩ Push [▶](F) to move the cursor.
- ⑪ Push [ABC](▶), and then rotate [MAIN DIAL] to select "Y."
- ⑫ Push [▶](F) to move the cursor.
- ⑬ Push [ABC](▶), and then rotate [MAIN DIAL] to select "U."
- ⑭ Push [▶](F) to move the cursor.
- ⑮ Rotate [MAIN DIAL] to select "A."
  - When entering a record name to another channel, push [T1..T8](F) several times to select a desired channel.

⑥ After entering, push [EXIT/SET] to save the name.

#### For your reference:

- Move the cursor: Push [◀](F) or [▶](F)
- Delete: Push [DEL](F)
  - Continuously holding down [DEL] (F) deletes the selected character and all characters to the right of the selected character.
- Enter a space: Push [SPACE](F)
- Select a character: Rotate [MAIN DIAL]

(▶) Multi-function keys

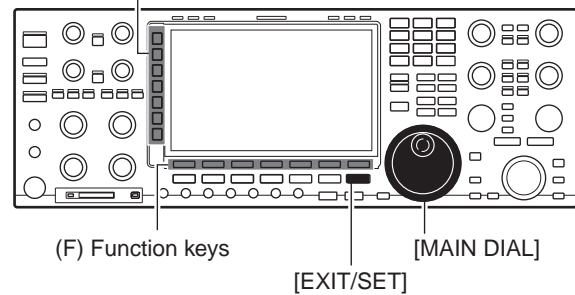

#### • The Voice MIC-Record screen (Before entry)

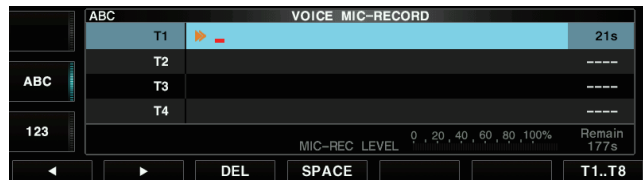

#### • The Voice MIC-Record screen (After entry)

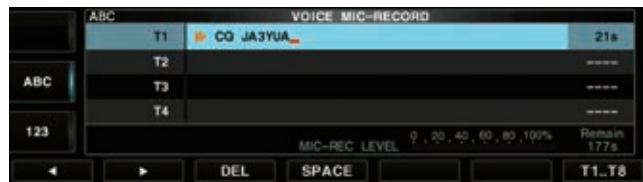

#### • Selectable characters and symbols

ABC	A B C D E F G H I J K L M N O P Q R S T U V W X Y Z
abc	a b c d e f g h i j k l m n o p q r s t u v w x y z
123	1 2 3 4 5 6 7 8 9 0
Symbol	! # \$ % & \ ? ' ` ^ + - * / . , : ; = < > ( ) [ ] { }   _ ~ @

## ■ Transmitting a recorded message

### ◇ Single TX

- The Multi-function screens are OFF.
- ① Push [VOICE](F).
  - The Voice memory screen is displayed.
- ② Push [SEND](F).
  - The Voice TX screen is displayed.
- ③ Push a desired Voice memory channel key, [T1](F) to [T8](F), to transmit the recorded voice audio.
  - Pushing [1-4/5-8](F) toggles the function key indication between [T1](F) to [T4](F) and [T5](F) to [T8](F).
  - The transceiver automatically transmits.
  - “SEND” appears and the memory timer counts down.
  - The transceiver automatically returns to receive when all of the recorded contents in the memory are transmitted.
  - To cancel transmission, push [T1](F) to [T8](F), [1-4/5-8](F), or [EXIT/SET].
- ④ Push [EXIT/SET] several times.
  - Exits the Voice memory screen.

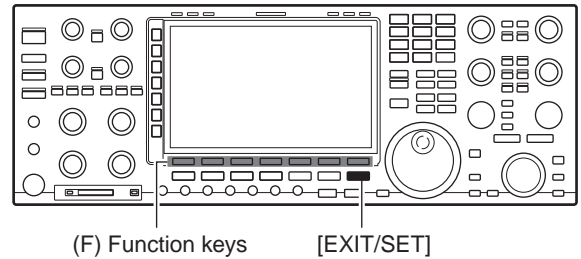

### • While transmitting (Single TX)

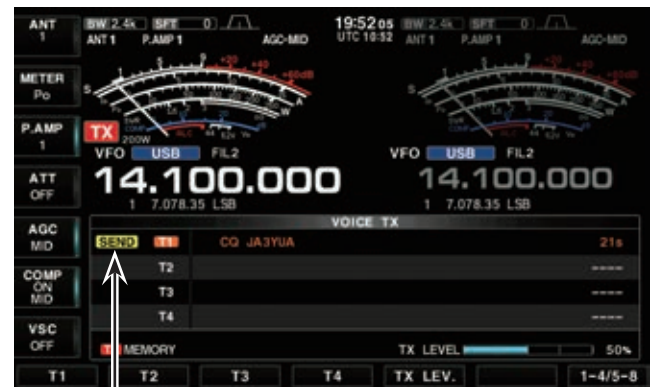

Appears

### ◇ Repeat TX

- ① Do steps ① and ② as described above.
  - ② Hold down a desired Voice memory channel key, [T1](F) to [T8](F), for 1 second.
    - Repeatedly transmits the recorded voice audio for up to 10 minutes, at the interval specified in “Repeat Time.” (p. 9-13)
- VOICE [F-2] ∨ SET [F-7] ∨ Repeat Time**
- “” appears while repeat transmission.
  - To cancel transmission, push [T1](F) to [T8](F), [1-4/5-8](F), or [EXIT/SET].

### • While transmitting (Repeat TX)

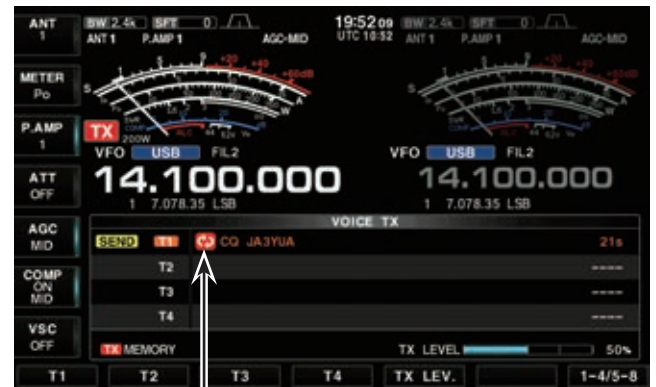

Repeat indicator

#### For your reference:

When an external keypad (pp. 3-6, 20-4) or PC keyboard is connected (p. 15-16), you can transmit the recorded messages.

- When pushing one of [S1] to [S8] on the external keypad, the recorded message in T1 to T8 is transmitted once.
- When holding down a key, the recorded message is repeatedly transmitted.
- When pushing one of [F1] to [F8] on the PC keyboard, the recorded message in T1 to T8 is transmitted once.
- When pushing a key while holding down [SHIFT], the recorded message is repeatedly transmitted.

## 9 VOICE RECORDER FUNCTIONS

### ■ Transmitting a recorded message (Continued)

#### ◇ Setting the transmit level

- The Multi-function screens are OFF.
- ① Push [VOICE](F).
  - The Voice memory screen is displayed.
- ② Push [SEND](F).
  - The VOICE TX screen is displayed.
- ③ Push [TX LEV.](F).
  - Opens the “TX LEVEL” window.
- ④ Push the desired Voice memory channel key, [T1](F) to [T8](F).
  - The transceiver automatically transmits.
  - Pushing [1–4/5–8](F) toggles the function key indication between [T1](F) to [T4](F) and [T5](F) to [T8](F).
  - “**SEND**” appears and the memory timer counts down.
  - The transceiver automatically returns to receive when all of the recorded contents in the memory are transmitted.
  - To cancel transmission, push [1–4/5–8](F), [T1](F) to [T8](F), or [EXIT/SET].
- ⑤ While transmitting, rotate [MAIN DIAL] to adjust the transmit voice level.
  - Hold down [DEF](F) for 1 second to select the default condition.
- ⑥ Push [EXIT/SET] several times.
  - Exits the Voice memory screen.

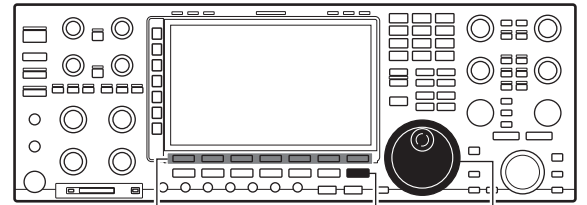

(F) Function keys [EXIT/SET] [MAIN DIAL]

#### • TX level window

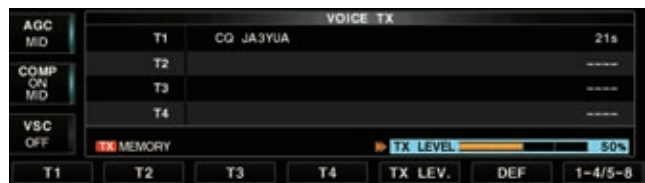

## ■ Voice Set mode

Sets the automatic monitor function, short play and normal recording times for the Voice Recorder.

- The Multi-function screens are OFF.
- ① Push [VOICE](F).
  - The Voice memory screen is displayed.
- ② Push [SET](F).
  - The VOICE SET screen is displayed.
- ③ Push [▲](F) or [▼](F) to select the desired item.
- ④ Rotate [MAIN DIAL] to set the desired level or value.
  - Hold down [DEF](F) for 1 second to select the default level or value.
- ⑤ Push [EXIT/SET] several times.
  - Exits the Voice memory screen.

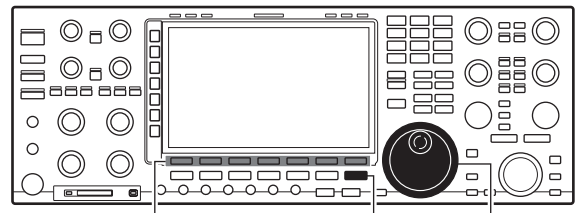

(F) Function keys [EXIT/SET] [MAIN DIAL]

### • Voice set screen

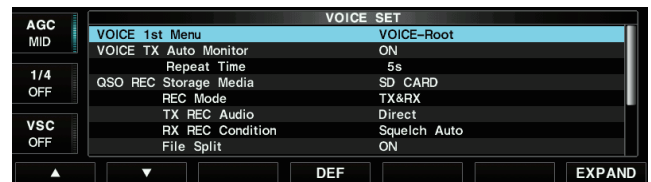

### Voice 1st Menu (Default: VOICE-Root)

Select VOICE-Root or VOICE-TX as the menu that appears first after pushing [VOICE](F).

- VOICE-Root: Displays the Voice memory screen first.
- VOICE-TX: Displays the Voice TX screen first.

### VOICE TX Auto Monitor (Default: ON)

Turn the Automatic Monitor function for recorded audio contents transmission, ON or OFF.

- ON: Automatically monitors transmit audio when sending a recorded audio.
- OFF: Monitors transmitting audio only when the Monitor function is in use.

### Repeat Time (Default: 5s)

Set the repeat interval for the voice repeat transmission.

The transceiver repeatedly transmits the recorded voice audio at this interval.

Value: Between 1 and 15 seconds (in 1 second steps)

### QSO REC Storage Media (Default: SD CARD)

Select the recorded audio save destination.

- SD CARD: Saves onto the SD card.
- USB-Memory: Saves onto the USB flash drive.

### Rec Mode (Default: TX&RX)

Select the recording mode to record a QSO audio.

- TX&RX: Records both the transmitted and received audio.
- RX only: Records only the received audio.

### TX Rec Audio (Default: Direct)

Select the recording audio to transmit.

- Direct: Records the microphone audio.
- Monitor: Records the TX monitor audio.

### RX Rec Condition (Default: Squelch Auto)

Select the recording condition for receive.

- Always: Records even if no signal is received.
- Squelch Auto: Records only when the squelch opens. (The recording will be paused when the squelch closes while recording.)

### File Split (Default: ON)

Turn the File Split function ON or OFF.

- OFF: The audio is continuously recorded into the file, even if you switch between transmit and receive or the squelch status changes between open and closed.

When the recording file's content becomes 2 GB, the transceiver continues to record, but to a new file.

- ON: While recording, and if you switch between transmit and receive, or the squelch status changes between open and closed, a new file is automatically created in the same folder, and the audio is saved into the new one.



## 9 VOICE RECORDER FUNCTIONS

### ■ Voice Set mode (Continued)

#### **PTT Auto REC** (Default: OFF)

Turn the PTT Automatic Recording function ON or OFF.

- OFF: The recording does not start even if a signal is transmitted.
- ON: The recording automatically starts when a signal is transmitted.

#### **The recording will stop when:**

- 10 seconds has passed without transmission after the last transmission.
- 10 minutes has passed with no signal after the last transmission.
  - If you receive a signal within 10 seconds after the last transmission, the received audio is also recorded.
  - If you receive another signal within 10 seconds after the last reception, the received audio is also recorded.
- 10 minutes has past while operating with the squelch is open in the SSB, CW, RTTY, PSK, or AM mode.
- The frequency or operating mode is changed.
- The operating method (V/M, M-CH, Band Stacking Register, and so on) is changed.

#### **PRE-REC for PTT Auto REC** (Default: 10s)

Select whether or not record the audio that is received before the PTT Automatic Recording function is activated.

- OFF: Does not record the audio that is received before the PTT Automatic Recording function is activated.
- 5s/10s/15s: Records the audio that is previously received this set period before the PTT Automatic Recording function is activated.

#### **QSO PLAY Skip Time** (Default: 10s)

Set the Skip time to forward or rewind while playing back the QSO audio.

Options: 3s, 5s, 10s, or 30s.

#### **INSTANT REPLAY REC Time** (Default: 15s)

Set the record time for the Instant replay function when [REC] is pushed.

Options: 5s to 30s (1 second steps)

#### **Play Time** (Default: 5s)

Set the playback time for the Instant replay function when [PLAY] is pushed.

Options: 3s to 10s (1 second steps)

## ■ Saving a voice memory onto an SD card or USB flash drive

The TX voice memory and the RX voice memory are saved onto an SD card or USB flash drive along with the memory channel contents and set mode settings. See "Saving the setting data onto an SD card or USB flash drive" on page 10-5 for more details.

To save the RX voice memory, set the "Voice RX Memory" item to ON, on the Save set screen. (p. 10-4)

**SET [F-7] ↘ SD/USB [F-7] ↘ SAVE [F-2] ↘  
Voice RX Memory**

- About the SD card ..... 10-2
  - ◇ Inserting the SD card ..... 10-2
  - ◇ Removing the SD card ..... 10-2
- SD/USB-Memory menu screen ..... 10-3
  - ◇ Save set screen ..... 10-4
  - ◇ Load set screen ..... 10-4
- Saving the setting data onto an SD card or USB flash drive ..... 10-5
- Loading the saved data files onto an SD card or USB flash drive ... 10-6
- Saving with a different file name ..... 10-7
- Deleting a data file ..... 10-8
- Formatting an SD card or USB flash drive..... 10-8
- Unmounting an SD card or USB flash drive ..... 10-9
- Screen Capture function ..... 10-10
  - ◇ Capturing the screen..... 10-10
  - ◇ Viewing the captured screen ..... 10-10

## About the SD card

An SDHC card is supplied.  
You can also use third party cards.

An SD card of up to 2 GB, or an SDHC of up to 32 GB, can be used.

Icom has checked the compatibility with the following SD and SDHC cards.

(As of July 2018)

Brand	Type	Memory size
SanDisk®	SD	2 GB
	SDHC	4 GB
		8 GB
		16 GB
		32 GB

- The above list does not guarantee the card's performance.
- Throughout the rest of this document, the SD card and an SDHC card are simply called SD cards or the card.
- Icom recommends that you format all SD cards to be used with the transceiver, even preformatted cards for PCs or other uses. (p. 10-8)

▨ Saving the transceiver's factory default data is recommended. (p. 10-5)

### ◇ Inserting the SD card

- Insert the card into the [SD CARD] slot until it locks in place, and makes a 'click' sound.
  - The indicator to the left of the [SD CARD] slot blinks.

▨ **NOTE:** Before inserting, be sure to check the card direction.  
▨ If the card is forcibly or inversely inserted, it will damage the card and/or the slot.

### ◇ Removing the SD card

- Push in the card until a click sounds, and then carefully pull it out.
  - Before you remove the card while the transceiver's power is ON, be sure to first unmount it. (p. 10-9)

### NOTE:

- Before using the SD card, thoroughly read the card's instructions.
- If you do any of the following, the card data may be corrupted or deleted.
  - A power failure occurs or the AC power cable is disconnected from an AC receptacle while accessing the card.
  - You turn OFF the internal power supply while accessing the card.
  - You remove the card from the transceiver while accessing the card.
  - You drop, impact or vibrate the card.
- Do not touch the contacts of the card.
- The transceiver takes a longer time to recognize a high capacity card.
- The card will get warm if used continuously for a long period of time.
- The card has a certain lifetime, so data reading or writing may not be possible after using it for a long time period.
- When reading or writing data is impossible, the card's lifetime has ended. In this case, purchase a new one. We recommend you make a backup file of the important data onto your PC.
- Icom will not be responsible for any damage caused by data corruption of an card.

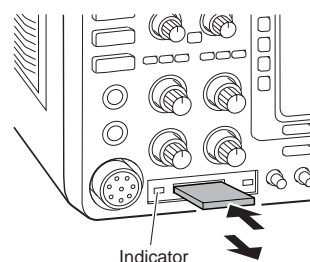
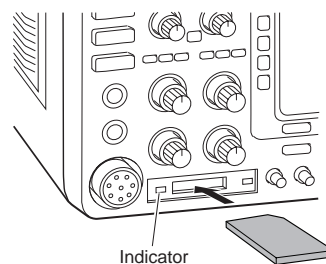

## SD/USB-Memory menu screen

You can select the various screens from the SD/USB-Memory menu screen to make detail settings.

### SD/USB-Memory menu screen

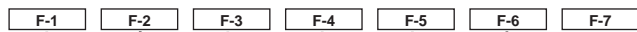
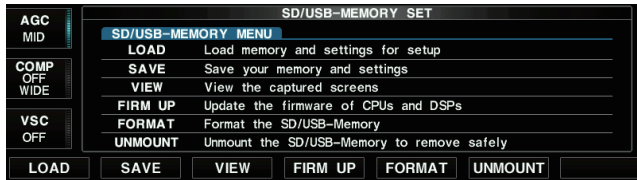

### Setting load screen (p. 10-6)

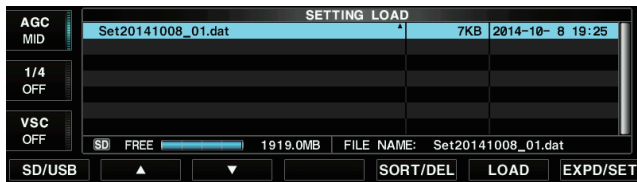

Hold down F-7

### Load set screen (p. 10-4)

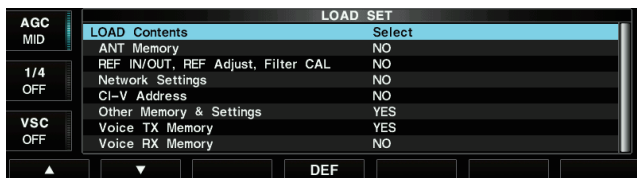

### Setting save screen (p. 10-5)

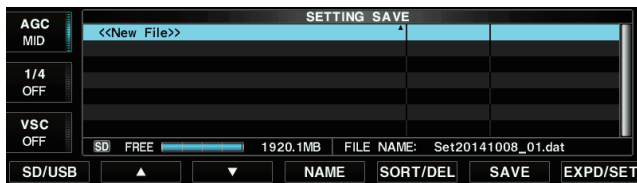

Hold down F-7

### Save set screen (p. 10-4)

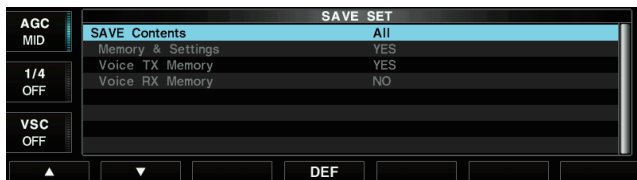

### Capture list screen (p. 10-10)

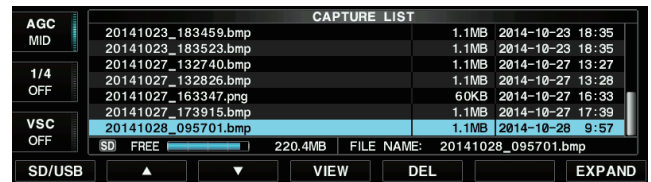

F-3

### Firmware update screen (p. 17-4)

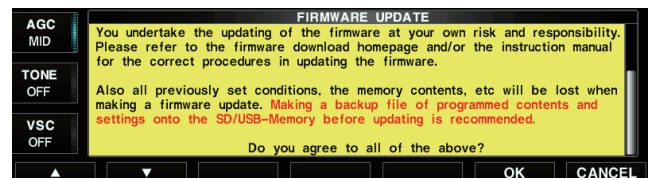

F-4

### Format screen (p. 10-8)

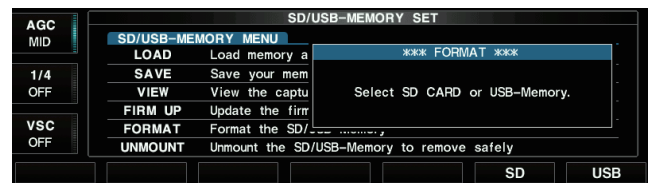

F-5

### Unmount screen (p. 10-9)

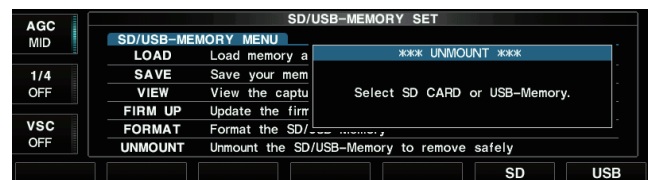

F-6

## 10 USING AN SD CARD OR USB FLASH DRIVE

### ■ SD/USB-Memory set screen (Continued)

#### ◇ Save set screen

##### **SAVE Contents** (Default: All)

Select the content to be saved onto the SD card or USB flash drive.

- All: All memories and settings are saved onto the card or flash drive.
- Select: The memories and settings are saved onto the card or flash drive, depending on the following settings.

##### **Memory & Settings** (Default: YES)

Select to save the Memory channel contents and the settings.

- YES: Saves

##### **Voice TX Memory** (Default: YES)

Select whether or not to save the Voice TX memory content.

- YES: Saves
- NO: Does not save

##### **Voice RX Memory** (Default: NO)

Select whether or not to save the Voice RX memory content.

- YES: Saves
- NO: Does not save

##### **SAVE Form** (Default: Now Ver)

Selects the file saving format between "Now Ver" and "Old Ver."

To save settings and memory contents for backup or copying to another IC-7850/IC-7851, you must save the data in the firmware version format that matches the target IC-7850/IC-7851.

Select "Now Ver" for the current version, or "Old Ver (xxx - xxx)" for the previous versions.

- The previous versions are shown in brackets, and you can select the desired version by rotating [MAIN DIAL]. The file will be saved in the selected version.

See page 17-2 for confirming the firmware version of the transceiver.

- Now Ver: Saves the file in the current firmware version format.
- Old Ver: Saves the file in the firmware version format shown in brackets.

#### NOTE:

- You cannot write setting file that is saved in the current version format to an older firmware version IC-7850/IC-7851.
- If the settings are saved in an older version format, the items added in later version are not saved.

#### ◇ Load set screen

##### **Load Contents** (Default: Select)

Select the contents to be loaded from the SD card or USB flash drive to the transceiver.

- All: All memories and settings of the file are loaded into the transceiver.
- Select: The specified memories and settings of the file are loaded into the transceiver, depending on the following settings.

##### **Antenna Memory** (Default: NO)

Select whether or not to load the antenna memory.

- YES: Loads
- NO: Does not load

##### **REF IN/OUT, REF Adjust, Filter CAL** (Default: NO)

Select whether or not to load the REF signal IN/OUT settings, REF adjustment values, and roofing filter calibration adjustment values.

- YES: Loads
- NO: Does not load

##### **Network Settings** (Default: NO)

Select whether or not to load the network settings.

- YES: Loads
- NO: Does not load

##### **CI-V Address** (Default: NO)

Select whether or not to load the CI-V address settings.

- YES: Loads
- NO: Does not load

##### **Other Memory & Settings** (Default: YES)

Select to load the Memory channel contents and the settings.

- YES: Loads

##### **Voice TX Memory** (Default: YES)

Select whether or not to load the Voice TX memory content.

- YES: Loads
- NO: Does not load

##### **Voice RX Memory** (Default: NO)

Select whether or not to load the Voice RX memory content.

- YES: Loads
- NO: Does not load

## ■ Saving the setting data onto an SD card or USB flash drive

Memory channels and transceiver's settings can be saved on a card or flash drive.

Saving data settings on a card or flash drive allows you to easily restore the transceiver to its previous settings, even if an All reset is performed.

- ① Displays the Setting save screen.

**SET [F-7] > SD/USB [F-7] > SAVE [F-2]**

- ② Push [SD/USB](F).

- Pushing [SD/USB](F) toggles the file save destination between the card and flash drive.

- ③ Push [SAVE](F).

- Opens the confirmation window.
- To cancel saving, push [CANCEL](F).

- ④ Push [OK](F).

- Saves the data settings to the selected destination.
- While saving to the card, the indicator to the left of the [SD CARD] slot blinks.
- While saving to the flash drive, the indicator to the right of the [SD CARD] slot blinks.
- You can change the content to be saved in the Save set screen. (p. 10-4)  
(SET [F-7] > SD/USB [F-7] > SAVE [F-2] > SAVE Contents)
- After saving, returns to the SD/USB-Memory set screen.

### • SD/USB-Memory set screen

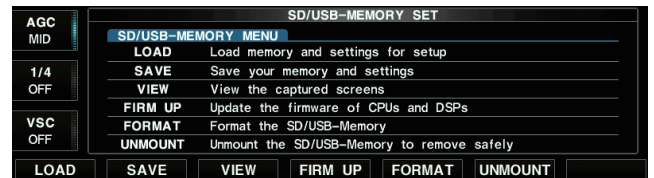

### • Setting save screen

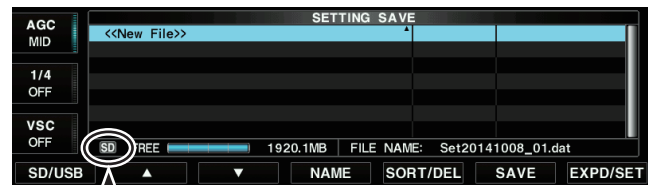

Destination is an SD card

### • Confirmation window

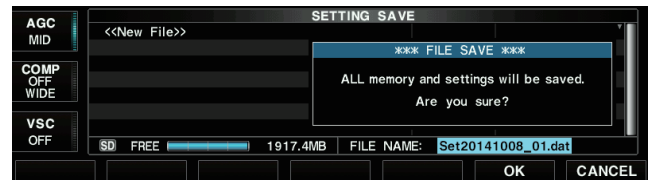



## ■ Loading the saved data files onto an SD card or USB flash drive

Memory channels and transceiver's settings on the card or flash drive can be copied to the transceiver.

This function is convenient when:

- Copying the saved data to another IC-7850/IC-7851 to operate with the same data.
- Using one IC-7850/IC-7851 by two or more operators with their own individual data.

Saving the current data is recommended before loading other data into the transceiver.

① Displays the Setting load screen.

**SET [F-7] > SD/USB [F-7] > LOAD [F-1]**

② Push [SD/USB](F).

- Push [SD/USB](F) toggles the file load source between the card and the flash drive.

③ Push [▲](F) or [▼](F) to select the desired file to be loaded.

④ Push [LOAD](F).

- Opens a confirmation window.
- To cancel loading, push [CANCEL](F).

⑤ Push [OK](F).

- Loads the data settings of the selected source.
- While loading from the card, the indicator to the left of the [SD CARD] slot lights.
- While loading from the flash drive, the indicator to the right of the [SD CARD] slot lights.
- You can change the content to be loaded in the Load set screen (p. 10-4).  
(SET [F-7] > SD/USB [F-7] > LOAD [F-1] > Load Contents)

⑥ After loading ends, reboot the transceiver

/// **NOTE:** To complete the loading process, you must reboot the transceiver.

### • Setting load screen

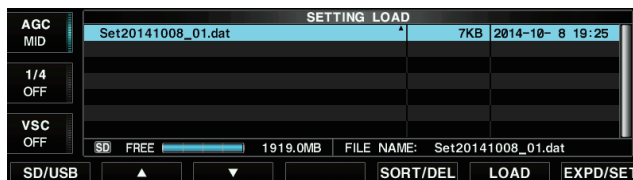

### • Confirmation window

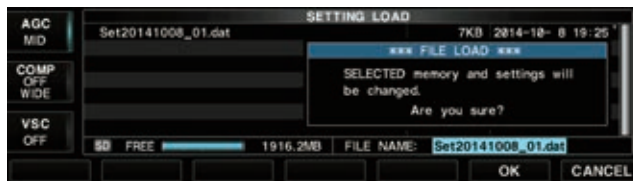

## ■ Saving with a different file name

You can change the file name when saving onto a card or flash drive.

The file name can be up to 15 characters.

Example: Changing a file name to JA3YUA.

- ① Displays the Setting save screen.
  - SET [F-7] > SD/USB [F-7] > SAVE [F-2]
- ② Push [SD/USB](F).
  - Pushing [SD/USB](F) toggles the file save destination between the card and the flash drive.
- ③ Push [NAME](F).
  - Enters the file name entry mode.
- ④ Push [DEL](F).
  - Deletes the pre-entered name.
- ⑤ Edit the desired characters by rotating [MAIN DIAL] or enter numbers by pushing keypad keys.

- ① When [ABC](▶) is selected, rotate [MAIN DIAL] to select "J."
- ② Push [▶](F) to move the cursor.
- ③ Rotate [MAIN DIAL] to select "A."
- ④ Push [▶](F) to move the cursor.
- ⑤ Push [123](▶), and then rotate [MAIN DIAL] to select "3."
- ⑥ Push [▶](F) to move the cursor.
- ⑦ Push [ABC](▶), and then rotate [MAIN DIAL] to select "Y."
- ⑧ Push [▶](F) to move the cursor.
- ⑨ Push [ABC](▶), and then rotate [MAIN DIAL] to select "U."
- ⑩ Push [▶](F) to move the cursor.
- ⑪ Rotate [MAIN DIAL] to select "A."
  - You can use a keyboard connected to the transceiver to enter text or numbers.

- ⑥ Push [EXIT/SET].
  - Returns to the Setting save screen.
- ⑦ Push [SAVE](F).
  - Opens the confirmation window.
  - To cancel loading, push [CANCEL](F).
- ⑧ Push [OK](F).
  - Saves the data settings to the selected destination.
  - While saving to the card, the indicator to the left of the [SD CARD] slot lights.
  - While saving to the flash drive, the indicator to the right of the [SD CARD] slot lights.
  - You can change the content to be saved in the Save set screen (p. 10-4).  
(SET [F-7] > SD/USB [F-7] > SAVE [F-2] > SAVE Contents)
  - After saving, returns to the SD/USB-Memory set screen.

### • Setting save screen

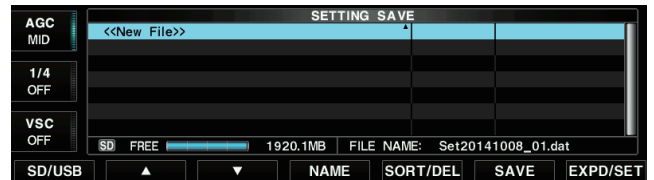

### • When entering "JA3YUA"

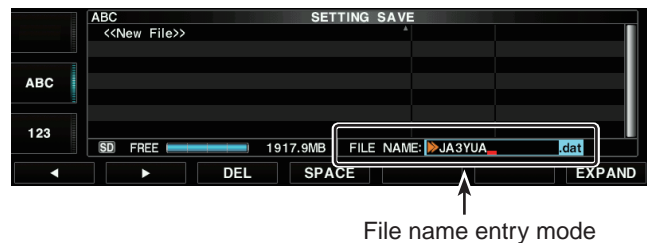

### • When changing a file name to "JA3YUA"

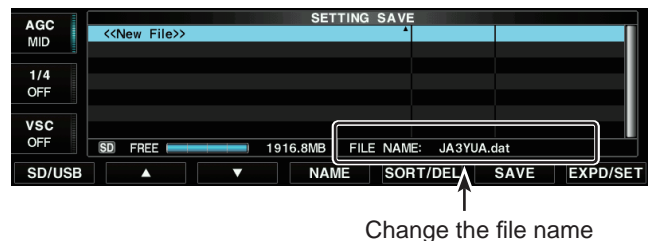

### • Confirmation window

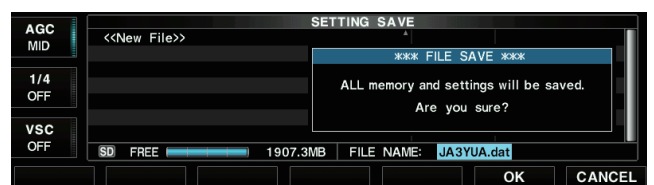

## Deleting a data file

**NOTE:** Deleted data from a card or flash drive cannot be restored. Before deleting any card or flash drive, back up its data onto your PC.

① Displays the Setting save screen.

**SET [F-7] ↘ SD/USB [F-7] ↘ SAVE [F-2]**

② Push [SD/USB](F).

- Pushing [SD/USB](F) toggles between the card and flash drive that the file to be deleted is stored.

③ Push [▲](F) or [▼](F) to select the desired file to be deleted.

③ Hold down [SORT/DEL](F) for 1 second.

- Opens the confirmation window.
- To cancel saving, push [CANCEL](F).

④ Push [OK](F).

- Deletes the selected file.
- While deleting the file in the card, the indicator to the left of the [SD CARD] slot blinks.
- While deleting the file in the flash drive, the indicator to the right of the [SD CARD] slot blinks.
- After deleting, returns to the Setting save screen.

### When selecting a file to be deleted



### Confirmation window

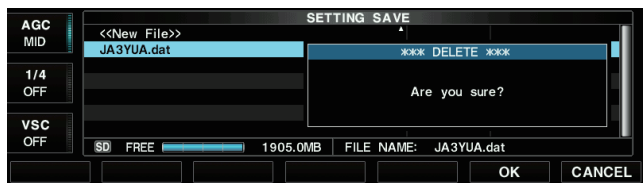

## Formatting an SD card or USB flash drive

**NOTE:** Formatting a card or flash drive erases all its data. Before formatting any used card, back up its data onto your PC.

If you use a brand new SD card, format it by doing the following steps.

① Display the SD/USB-Memory set screen.

**SET [F-7] ↘ SD/USB [F-7]**

② Hold down [FORMAT](F) for 1 second.

- Opens the "FORMAT" window.

③ Push [SD](F) or [USB](F).

- Opens the confirmation window.
- To cancel saving, push [CANCEL](F).

④ Push [OK](F).

- After formatting, returns to the SD/USB-Memory set screen.

### SD/USB-Memory set screen

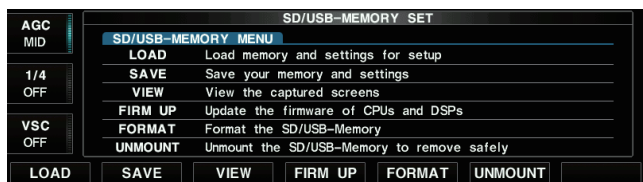

### Format screen

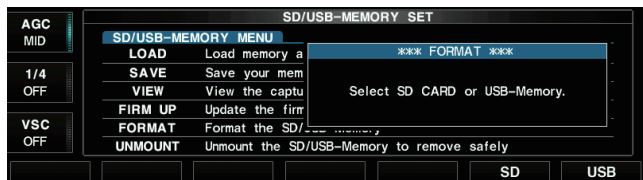

### Confirmation window

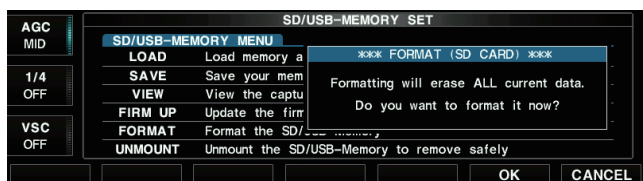

## ■ Unmounting an SD card or USB flash drive

Electrically unmounts the card or flash drive when the power is ON.

**NOTE:** If you remove a card or flash drive from the transceiver without unmounting, the data may be corrupted or deleted.

- ① Displays the SD/USB-Memory set screen.

**SET [F-7] ▸ SD/USB [F-7]**

- ② Hold down [UNMOUNT](F) for 1 second.

- Opens the “UNMOUNT” window.

- ③ Push [SD](F) or [USB](F).

- Opens a confirmation window.

- To cancel saving, push [CANCEL](F).

- ④ Push [OK](F).

- After unmounting, returns to the SD/USB-Memory set screen.

- ⑤ Remove the card or flash drive from the transceiver.

### • SD/USB-Memory set screen

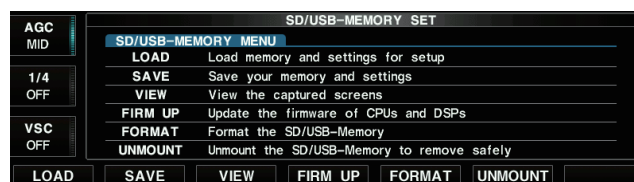

### • Unmount screen

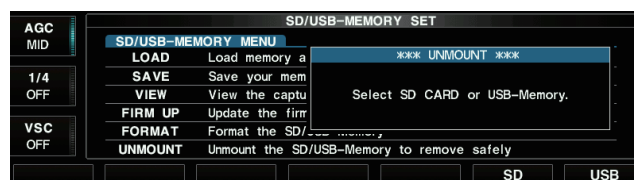

### • When unmounting the SD card

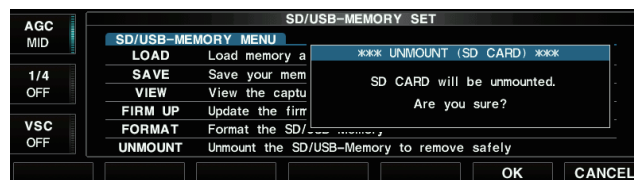

### • When unmounting the USB flash drive

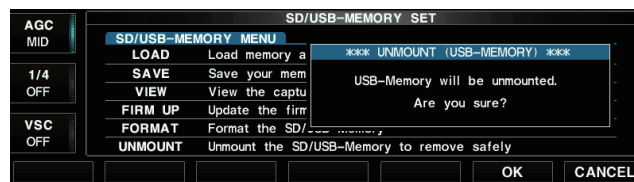

## ■ Screen Capture function

You can capture the transceiver display onto the SD card or USB flash drive. Most of the screens described in this manual were captured using this function.

**NOTE:** Some screens cannot be captured.

### ◇ Capturing the screen

- ① Select the “Screen Capture [POWER] SW” item in the Others set screen.

**SET [F-7] ▾ OTHERS [F-5] ▾ Screen Capture [POWER] SW**

- ② Rotate [MAIN DIAL] to select “ON.”

- The Screen capture function is assigned to the [POWER] key.

You can also assign the function to the [Print Screen] key on the USB keyboard.

If desired, select the storage media between the SD card and USB flash drive, or select the data format between PNG and BMP.

- ③ Push [EXIT/SET] several times.

- Exits the Set screen.

- ④ Select a desired screen.

- ⑤ Push [POWER] to capture the screen.

- The captured screen is saved onto the selected storage media in the selected data format.

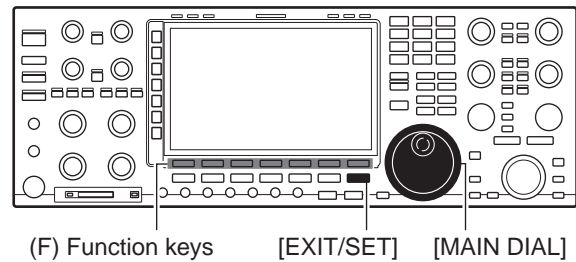

### • Others set screen

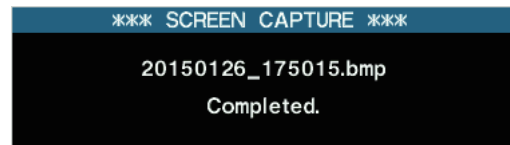
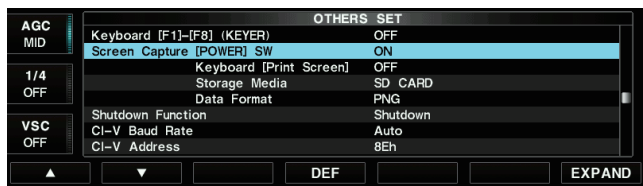

### ◇ Viewing the captured screen

- ① Displays the SD/USB-Memory set screen.

**SET [F-7] ▾ SD/USB [F-7]**

- ② Push [VIEW](F).

- The Capture list screen is displayed.

- ③ Push [▲](F) or [▼](F) to select a desired file.

- ④ Push [VIEW](F) to display the captured screen.

- The [MAIN] or [SUB] key blinks while displaying the file.

- ⑤ After checking the file, push [EXIT/SET] twice.

- Exits the Capture list screen.

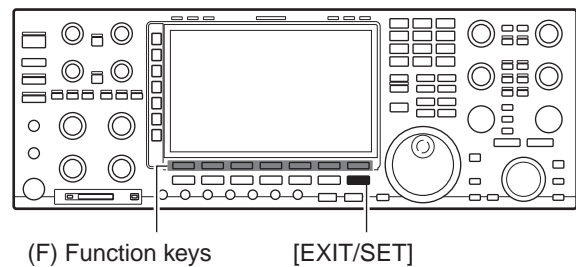

### • Functions in the Capture list screen

Function	Action
SD/USB	Toggles between an SD card and USB flash drive.
▲	Selects a file.
▼	
VIEW	Displays the captured screen. <ul style="list-style-type: none"> <li>• The [MAIN] or [SUB] key blinks while displaying the file.</li> <li>• Push [EXIT/SET] to return to the Capture list screen.</li> </ul>
DEL	Hold down for 1 second to display the dialog box for deleting.
EXPAND	Toggles between the Expanded and normal screens.

### • Capture list screen

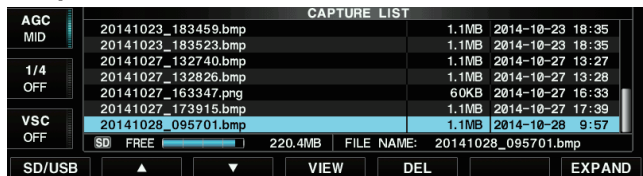

---

■ Memory channels .....	11-2
■ Memory channel selection .....	11-2
◇ Using the M-CH [▲] or [▼] keys .....	11-2
◇ Using the keypad .....	11-2
■ Memory list screen.....	11-3
◇ Selecting a memory channel using the Memory list screen .....	11-3
◇ Confirming programmed memory channels .....	11-3
■ Entering Memory channel contents .....	11-4
◇ Entering in the VFO mode .....	11-4
◇ Entering in the Memory mode .....	11-4
■ Copying Memory contents .....	11-5
◇ Copying in the VFO mode .....	11-5
◇ Copying in the Memory mode .....	11-5
■ Memory names .....	11-6
◇ Editing (programming) memory names .....	11-6
■ Memory clearing.....	11-6
■ Memo pads .....	11-7
◇ Entering frequencies and operating modes into Memo pads .....	11-7
◇ Calling up a frequency and operating mode from Memo pads ...	11-8
◇ Using the Memo pad list screen .....	11-8



## Memory channels

The transceiver has 101 memory channels. The Memory mode is very useful for quickly selecting often-used frequencies.

All 101 memory channels are tunable, which means the entered frequency can be temporarily tuned by rotating [MAIN DIAL].

MEMORY CHANNEL	MEMORY CHANNEL NUMBER	CAPABILITY	TRANSFER TO VFO	OVER-WRITING	CLEAR
Regular memory channels	1–99	One frequency and one mode in each memory channel.	Yes	Yes	Yes
Scan Edge memory channels	P1, P2	One frequency and one mode in each memory channel as scan edges for programmed scans.	Yes	Yes	No

## Memory channel selection

### Using the M-CH [▲] or [▼] keys

- Push [V/M] to select the Memory mode.
- Push M-CH [▲] or [▼] several times to select the desired memory channel.
  - Hold down M-CH [▲] or [▼] to continuously change the memory channels.
  - You can also push [UP] and [DN] on microphone keys.
- To return to the VFO mode, push [V/M] again.

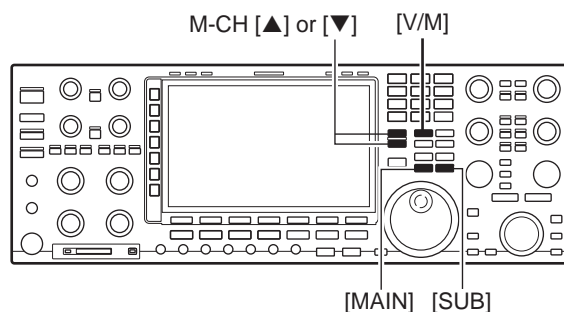

### Using the keypad

- Push [V/M] to select the Memory mode.
- Push [F-INP].
- Push the keypad keys to enter the desired memory channel number.
  - Enter 100 or 101 to select Scan Edge channels P1 or P2.
- Push M-CH [▲] or [▼] to switch to the entered memory channel.

### Memory mode

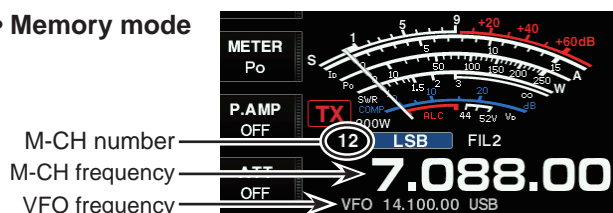

### [EXAMPLE]

To select memory channel 3:

- Push [F-INP•ENT], [3], then push M-CH [▲] or [▼].

To select memory channel 12:

- Push [F-INP•ENT], [1], [2], then push M-CH [▲] or [▼]

To select Scan Edge channel P1:

- Push [F-INP•ENT], [1], [0], [0], then push M-CH [▲] or [▼].

To select Scan Edge channel P2:

- Push [F-INP•ENT], [1], [0], [1], then push M-CH [▲] or [▼].

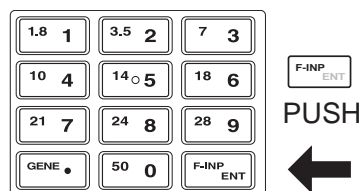

## ■ Memory list screen

The Memory list screen simultaneously shows 9 memory channels and their programmed contents. 15 memory channels can be displayed in the expanded Memory list screen.

You can select a desired memory channel from the Memory list screen.

### ◇ Selecting a memory channel using the Memory list screen

○ The Multi-function screens are OFF:

- ① Push [MEMORY](F).
  - The Memory list screen is displayed.
  - Push [EXPAND](F) to toggle between the standard and expanded screens.
- ② While holding down [ROLL](F), rotate [MAIN DIAL] to select the desired memory channel.
  - M-CH [▲] or M-CH [▼] can also be used.
- ③ Push [EXIT/SET].
  - Exits the Memory list screen.

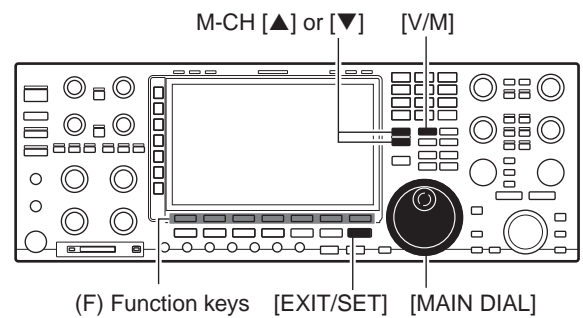

### • Memory list screen

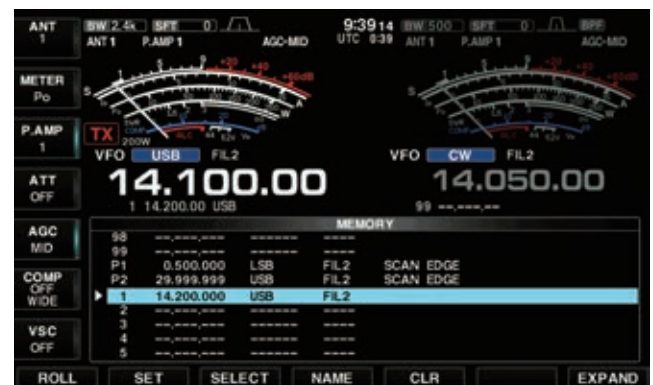

### ◇ Confirming programmed memory channels

- ① Push [MEMORY](F).
  - The Memory list screen is displayed.
  - Push [EXPAND](F) to toggle between the standard and expanded screens.
- ② While holding down [ROLL](F), rotate [MAIN DIAL] to scroll the screen.
- ③ Push [SET](F) to select the highlighted memory channel.
  - “▶” appears beside the selected memory channel number in the Memory list screen and the selected memory channel contents are displayed below the frequency readout.
- ④ Push [EXIT/SET]
  - Exits the Memory list screen.

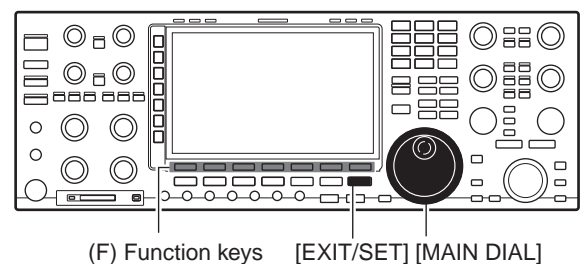

## ■ Entering Memory channel contents

You can enter Memory channel in either the VFO or Memory mode.

### ◇ Entering in the VFO mode

- ① Push [V/M] to select the VFO mode.
- ② Set the desired frequency, operating mode and filter.
- ③ Push M-CH [▲] or [▼] several times to select the desired preset memory channel.
  - The Memory list screen is convenient for selecting the desired channel.
  - Memory channel contents are displayed in the memory channel readout (below the frequency readout).
  - “-.-.-.-” is displayed if the selected memory channel is a blank channel (does not have contents). Blank channels cannot be entered in the VFO mode.
- ④ Hold down [MW] for 1 second to save the displayed frequency, operating mode, filter and so on, into the memory channel.

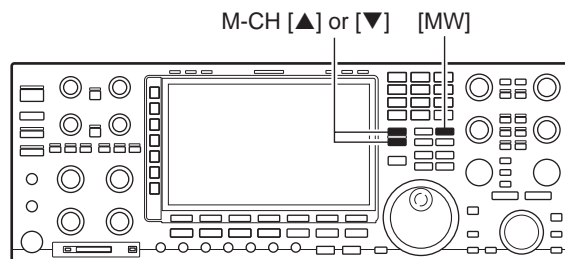

[EXAMPLE]: Programming 7.088 MHz/LSB into memory channel 12.

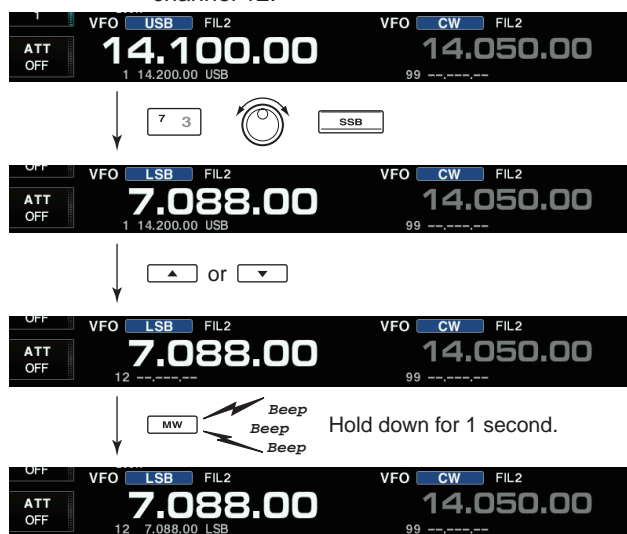

### ◇ Entering in the Memory mode

- ① Push [V/M] to select the Memory mode.
- ② Select the desired memory channel by pushing M-CH [▲] or [▼].
  - Memory channel contents are displayed in the memory channel readout (below the frequency readout).
  - “-.-.-.-” appears if the selected memory channel is a blank channel (does not have contents).
- ③ Set the desired frequency, operating mode and filter.
  - To enter contents into a blank channel, use direct frequency entry with the keypad or memo pads, and so on.
- ④ Hold down [MW] for 1 second to save the displayed frequency, operating mode, filter, and so on into the memory channel.

[EXAMPLE]: Programming 21.288 MHz/USB into memory channel 18.



## ■ Copying Memory contents

The frequency and operating mode in a memory channel can be copied to the VFO. Copying can be performed in either the VFO or Memory mode.

### ◇ Copying in the VFO mode

This is useful for copying Memory contents to the VFO mode.

- ① Push [V/M] to select the VFO mode.
- ② Push M-CH [▲] or M-CH [▼] to select the memory channel to be copied.
  - The Memory list screen is convenient for selecting the desired channel.
  - Memory channel contents appear in the memory channel readout (below the frequency readout).
  - “---,---,---” appears if the selected memory channel is a blank channel. In this case, there is nothing to copy.
- ③ Hold down [V/M] for 1 second to copy the frequency and operating mode to the VFO.
  - The displayed frequency and operating mode are copied to the VFO.

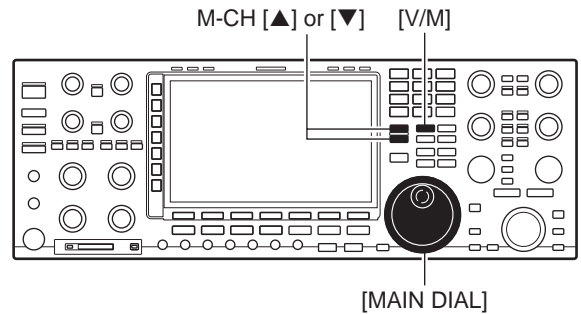

**[EXAMPLE]:** Copying in the VFO mode  
 Operating frequency: 21.320 MHz/USB (VFO)  
 Contents of M-ch 16: 14.108 MHz/CW



### ◇ Copying in the Memory mode

This is useful for copying frequency and operating mode while operating in the Memory mode.

When you have changed the frequency or operating mode in the selected memory channel:

- **Displayed** frequency, mode and filter setting are copied to the VFO mode.
- **Memorized** frequency and mode in the memory channel are not changed, and they remain in the memory channel.

- ① Select the memory channel to be copied by pushing M-CH [▲] or M-CH [▼] in the Memory mode.
  - Enter the frequency or operating mode, if required.
- ② Hold down [V/M] for 1 second to copy the frequency and operating mode.
  - The displayed frequency and operating mode are copied to the VFO.
- ③ To return to the VFO mode, push [V/M].

**[EXAMPLE]:** Copying in the Memory mode  
 VFO frequency: 21.320 MHz/USB  
 Contents of M-ch 16: 14.108 MHz/CW

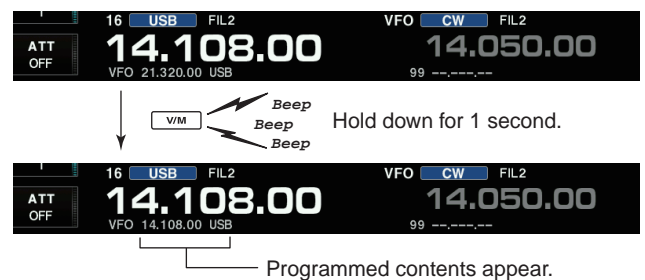

# 11 MEMORY OPERATION

## Memory names

All memory channels (including scan edges) can be assigned alphanumeric names of up to 10 characters.

Upper case letters, lower case letters, numerals, some symbols and spaces can be used.

### Editing (programming) memory names

The Multi-function screens are OFF:

- ① Push [MEMORY](F).
  - The Memory list screen is displayed.
- ② Select the desired memory channel.
- ③ Push [NAME](F) to edit the memory channel name.
  - A cursor appears and blinks.
  - Memory channel names of blank channels cannot be edited.
- ④ Edit the desired character by rotating [MAIN DIAL] or by pushing keypad.
  - Push [ABC](▶) or [abc](▶) to toggle between upper case and lower case letters.
  - Push [123](▶) or [Symbol](▶) to toggle between numbers and symbols.
  - Push [◀](F) or [▶](F) to move the cursor.
  - Push [DEL](F) to delete the selected character.
  - Push [SPACE](F) to enter a space.
  - Pushing keypad, [0]–[9], can also enter numbers.
- ⑤ Push [EXIT/SET] to save the name.
  - The cursor disappears.
- ⑥ Repeat steps ② to ⑤ to program another memory channel's name, if desired.
- ⑦ Push [EXIT/SET].
  - Exits the Memory list screen.

(▶) Multi-function keys M-CH [▲] or [▼] [V/M]

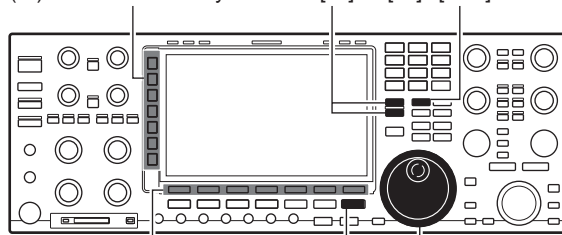

(F) Function keys [EXIT/SET] [MAIN DIAL]

### Enters the memory name

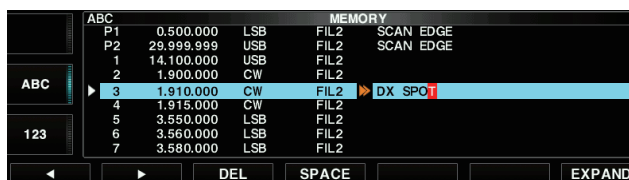

ABC	A B C D E F G H I J K L M N O P Q R S T U V W X Y Z
abc	a b c d e f g h i j k l m n o p q r s t u v w x y z
123	1 2 3 4 5 6 7 8 9 0
Symbol	! # \$ % & \ ? ' ' ^ + - * / . , : ; = < > ( ) [ ] { }   _ ~ @

## Memory clearing

Any unnecessary memory channels can be cleared. The cleared memory channels become blank channels.

- ① Select the memory mode by pushing [V/M].
- ② Push [MEMORY](F).
  - The Memory list screen is displayed.
- ③ Select the desired memory channel by pushing M-CH [▲] or [▼].
- ④ Hold down [CLR](F) for 1 second to clear the contents.
  - The frequency and operating mode disappear.
- ⑤ To clear other memory channels, repeat steps ③ and ④.

[V/M]

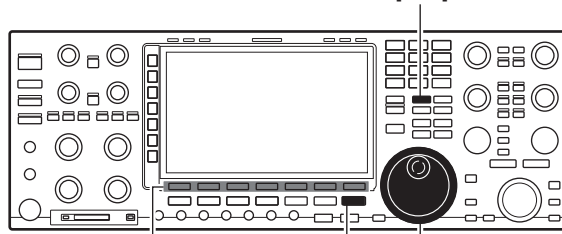

(F) Function keys [EXIT/SET] [MAIN DIAL]

### Memory clearing

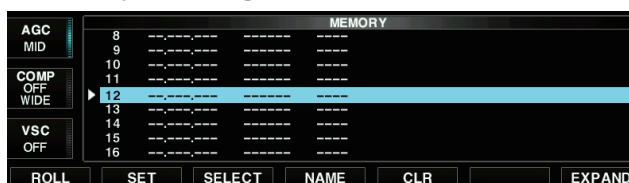

## ■ Memo pads

The transceiver has a Memo Pad function to store frequency and operating mode for easy write and recall. The Memo pads are separate from memory channels.

The function is commonly used for the Main and Sub bands.

The default quantity of Memo pads is 5. However, this can be increased to 10 in the Others set mode, if desired. (p. 15-15)

Memo pads are convenient when you want to temporarily memorize a frequency and operating mode, such as when you find a DX station in a pile-up, or when a desired station is busy for a long time and you want to temporarily search for other stations.

- The function can be used in both the VFO and memory modes.

Use the transceiver's Memo pads instead of relying on hastily scribbled notes that are easily misplaced.

### ◇ Entering frequencies and operating modes into Memo pads

You can easily write the accessed readout frequency and operating mode by pushing [MP-W].

When you enter a 6th memo pad, the oldest memo pad is automatically erased to make room for the new entry.

Each Memo pad must have its own unique combination of frequency and operating mode. Memo pads having identical settings cannot be entered.

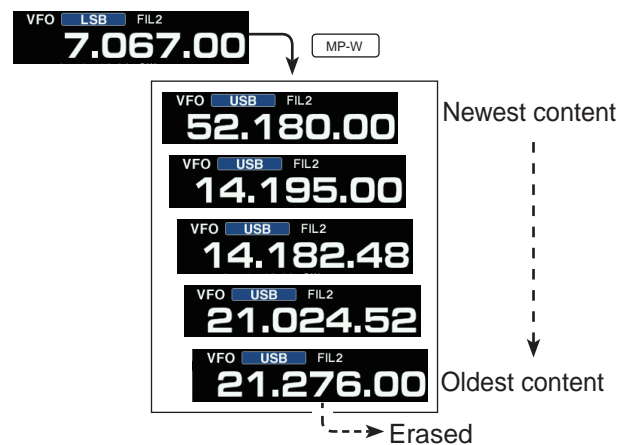
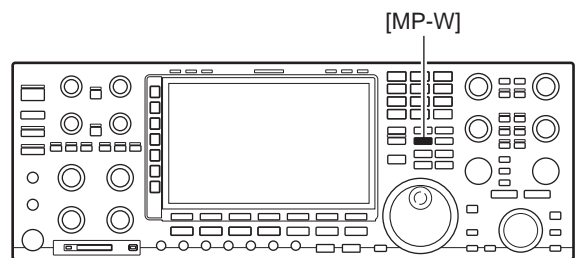

In this example, 21.276 MHz (USB) will be erased when 7.067 MHz (LSB) is entered.



# 11 MEMORY OPERATION

## ■ Memo pads (Continued)

### ◇ Calling up a frequency and operating mode from Memo pads

You can easily call up the desired frequency and operating mode of Memo pads by pushing [MP-R] several times.

- The frequency and operating mode are called up, starting from the most recently entered.

When you call up a frequency and an operating mode from Memo pads by pushing [MP-R], the previously displayed frequency and operating mode are automatically stored in a temporary pad. The frequency and operating mode in the temporary pad can be recalled by pushing [MP-R] several times.

- You may think there are 6 Memo pads because 6 different frequencies are called up by [MP-R] (5 are in Memo pads and 1 is in the temporary pad).

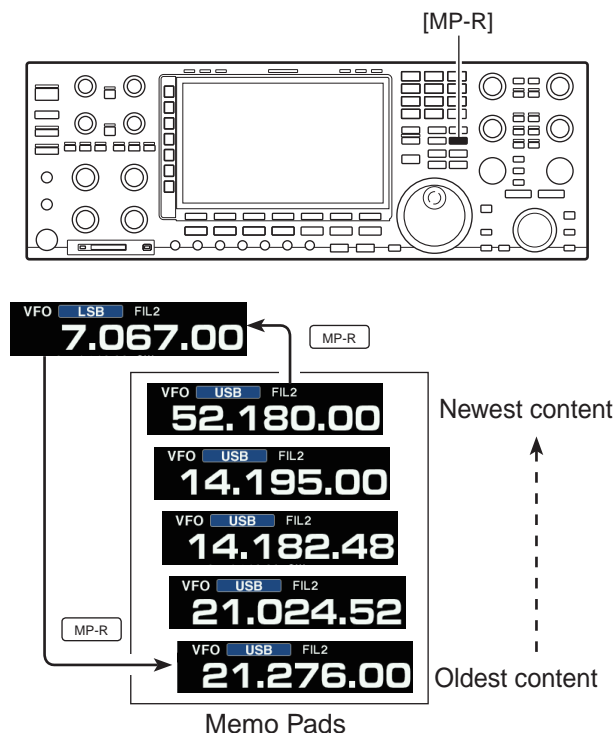

### ◇ Using the Memo pad list screen

- ① Hold down [MP-R] for 1 second.
  - The Memo pad list screen is displayed.
- ② Push [▲](F) or [▼](F) to select the desired Memo pad.
  - Hold down [DEL](F) for 1 second to delete the selected Memo pad.
  - Hold down [DEL ALL](F) for 1 second to delete all Memo pads.
- ③ Push [EXIT/SET].
  - Exits the Memo pad list screen.

▨ If you change the frequency or operating mode called up from Memo pads, the frequency and operating mode in the temporary pad are updated.

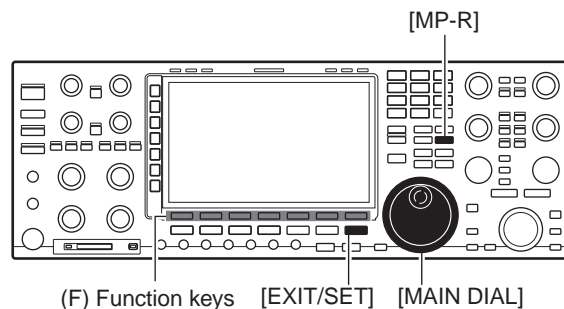

### • Memo pad list screen

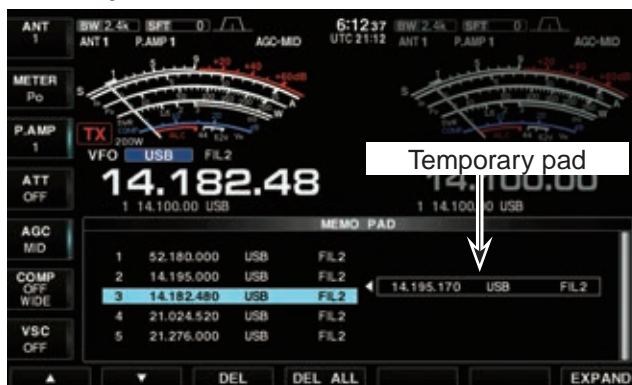

■ Scan types .....	12-2
■ Preparing for a scan .....	12-3
■ Scan set mode .....	12-4
■ Programmed scan .....	12-5
■ Fine Programmed scan.....	12-6
■ Memory scan .....	12-7
■ Select memory scan .....	12-7
■ Setting Select memory channels.....	12-8
◇ Setting in the Scan screen .....	12-8
◇ Setting in the Memory list screen .....	12-8
◇ Erasing the Select scan setting .....	12-8
■ ΔF scan .....	12-9
■ Fine ΔF scan .....	12-9
■ Tone scan .....	12-10
■ Voice Squelch Control function .....	12-10

## Scan types

- The scan functions can be used on the Main band only.
- You can scan while operating on a frequency using the Dualwatch or Split functions.

### PROGRAMMED SCAN

Repeatedly scans between two Scan Edge frequencies (Scan Edge memory channels P1 and P2).

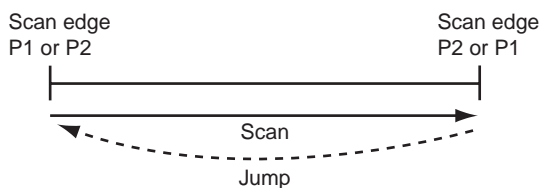

This scan works in the VFO mode.

### $\Delta F$ SCAN

Repeatedly scans within the  $\Delta F$  span area.

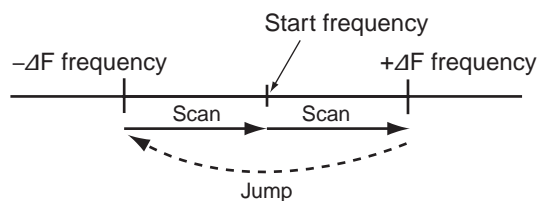

This scan works in both the VFO and Memory modes.

### MEMORY SCAN

Repeatedly scans all programmed memory channels.

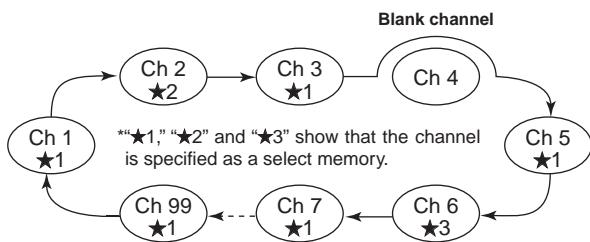

This scan works in the Memory mode.

### SELECT MEMORY SCAN

Repeatedly scans all or one of 3 select memory channels.

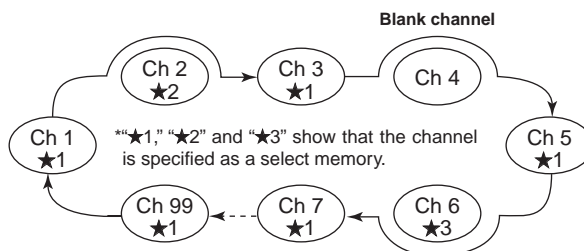

This scan works in the Memory mode.

## ■ Preparing for a scan

### For a Programmed scan:

Enter Scan Edge frequencies into the Scan Edge memory channels P1 and P2.

### For a $\Delta F$ scan:

Set the  $\Delta F$  span ( $\Delta F$  scan range) in the Scan screen.

### For a Memory scan:

Enter frequencies in two or more memory channels, except Scan Edge memory channels.

### For a Select memory scan:

Assign two or more memory channels as Select memory channels. To designate the channel as a select memory channel, choose a memory channel, then push [SELECT](F) in the Scan screen (Memory mode) or in the Memory list screen.

#### • Scan Resume function

You can set the scan to resume or cancel when detecting a signal in the Scan set mode. The Scan Resume function must be set before starting a scan. (p. 12-4)

#### • Scan speed

The scan speed can be set to high or low in the Scan set mode. (p. 12-4)

#### • Squelch status

##### ○ The scan starts with the squelch open

#### For a Programmed scan:

When the tuning step is 1 kHz or less:

The scan continues until it is manually stopped— it does not pause\* even if signals are detected.

\*The scan pauses when the squelch is closed and then opened. The scan resumes after 10 seconds has passed when the Scan Resume function is ON. It is cancelled when the function is OFF.

When the tuning step is more than 5 kHz:

The scan pauses on each step when the Scan Resume function is ON. It does not pause when the function is OFF.

#### For a memory scan:

If Scan pauses on each channel when the Scan Resume function is ON. The scan does not pause when the function is OFF.

##### ○ Scan starts with the squelch closed

The scan stops when a signal is detected.

• If the Scan Resume function is set to ON, the scan pauses for 10 seconds when detecting a signal, then resumes. If the scan is paused, it resumes 2 seconds after the signal disappears.

## ■ Scan set mode

When the squelch is open, the scan continues until it is manually stopped — it does not pause on detected signals. When the squelch is closed, the scan stops when a signal is detected, then resumes according to the Scan Resume setting. The scan speed and the Scan Resume setting can be set in the Scan set mode.

○ The Multi-function screens are OFF.

- ① Push [SCAN](F).
  - The Scan screen is displayed.
- ② Push [SET](F).
  - The Scan set screen is displayed.
- ③ Push [▲](F) or [▼](F) to select the desired item.
- ④ Rotate [MAIN DIAL] to select the desired setting.
  - Hold down [DEF](F) for 1 second to select the default setting.
- ⑤ Push [EXIT/SET].
  - Exits the Set screen.

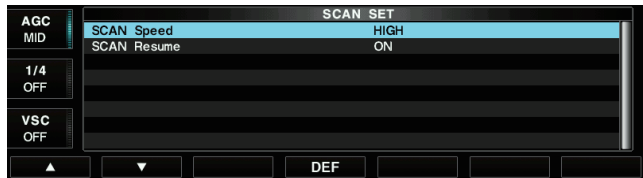
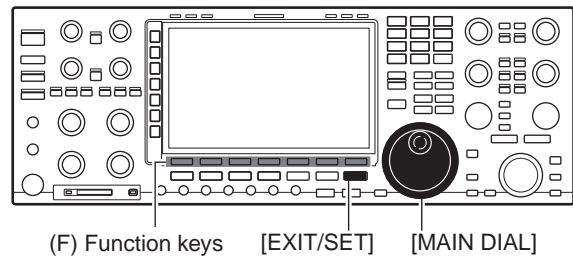

### **SCAN Speed** (Default: HIGH)

Set the desired scan speed to high or low.

- HIGH: Scan is faster
- LOW: Scan is slower.

### **SCAN Resume** (Default: ON)

Set the scan resume function to ON or OFF.

- ON: When a signal is detected, scan pauses for 10 seconds, then resumes. Two seconds after the signal disappears, the scan resumes.
- OFF: When detecting a signal, cancels scanning.

## ■ Programmed scan

A Programmed scan searches for signals between Scan Edge memory channels "P1" and "P2."

Before starting the programmed scan, you must enter Scan Edge frequencies into these channels.

▨ If the same frequencies are entered into Scan Edge memory channels P1 and P2, the Programmed scan does not start.

○ The Multi-function screens are OFF.

① Push [V/M].

- Selects the VFO mode.
- Push [V/M] toggles between the VFO and Memory modes.

② Push a Mode key to select the desired operating mode.

- The operating mode can be changed while scanning.

③ Push [TS] to select the desired tuning steps. (p. 4-7)

- The tuning steps can be changed while scanning.

④ Push [SCAN](F).

- The Scan screen is displayed.

⑤ Push [PROG](F).

- The Programmed scan starts.
- "PROGRAM SCAN" and decimal points blink while scanning.
- Push [PROG](F) to cancel the scan.
- Rotating [MAIN DIAL] also cancels the scan.
- Hold down [RECALL](F) for 1 second to recall the frequencies that are set before starting the scan (P1 and P2), if desired.

⑥ When the scan detects a signal, the scan stops, pauses or ignores it, depending on the Scan Resume setting and the squelch status.

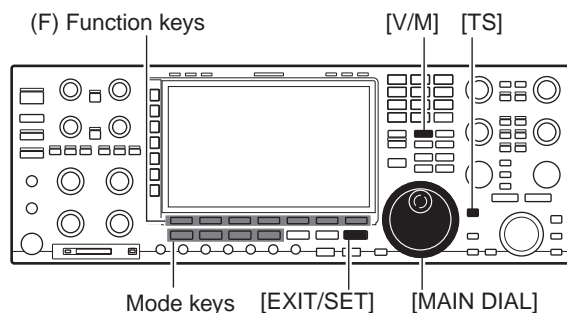

### • While scanning





## ■ Fine Programmed scan

In the Fine Programmed scan, the scan speed decreases when the squelch opens, but the transceiver keeps scanning. The scanning tuning step changes to 10 Hz when the squelch opens.

○ The Multi-function screens are OFF.

- ① Push [SCAN](F).
  - The Scan screen is displayed.
- ② Set for a Programmed scan as described on page 12-5.
- ③ Push [PROG](F).
  - The Programmed scan starts.
  - “PROGRAM SCAN” and decimal points blink while scanning.
- ④ Push [FINE](F).
  - The Fine programmed scan starts.
  - “FINE PROGRAM SCAN” blinks.
  - Push [FINE](F) to release the Fine Programmed scan.
  - Push [PROG](F) to cancel the scan.
  - Rotating [MAIN DIAL] also cancels the scan.
  - Hold down [RECALL](F) for 1 second to recall the frequencies that are set before starting the scan (P1 and P2), if desired.

When the scan detects a signal, the scan speed decreases but the scan does not stop.

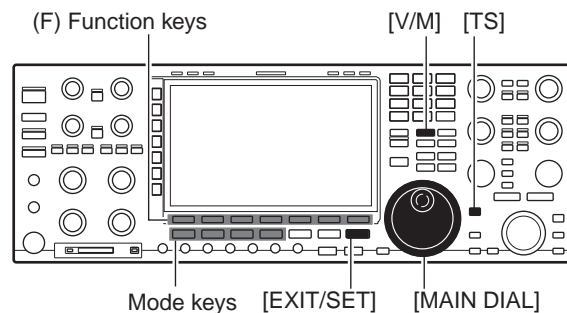

### • While scanning

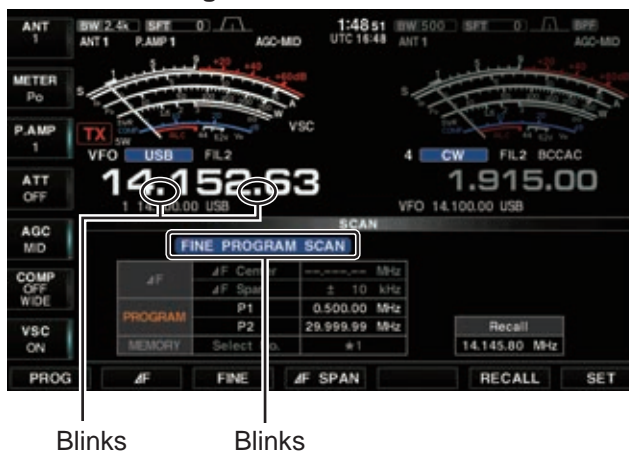

## Memory scan

○ The Multi-function screens are OFF.

- ① Push [V/M].
  - Selects the Memory mode.
  - Pushing [V/M] toggles between the VFO and Memory modes.
- ② Push [SCAN](F).
  - The Scan screen is displayed.
- ③ Push [MEMO](F).
  - The Memory scan starts.
  - “**MEMORY SCAN**” and decimal points blink while scanning.
  - Push [MEMO](F) to cancel the scan.
  - Rotating [MAIN DIAL] also cancels the scan.
- ④ When the scan detects a signal, the scan stops, pauses or ignores it, depending on the Scan Resume setting and the squelch status.

▨ Two or more memory channels must be programmed for the Memory scan to start.

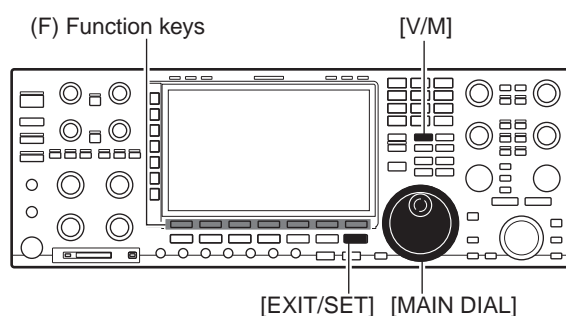

### • While scanning

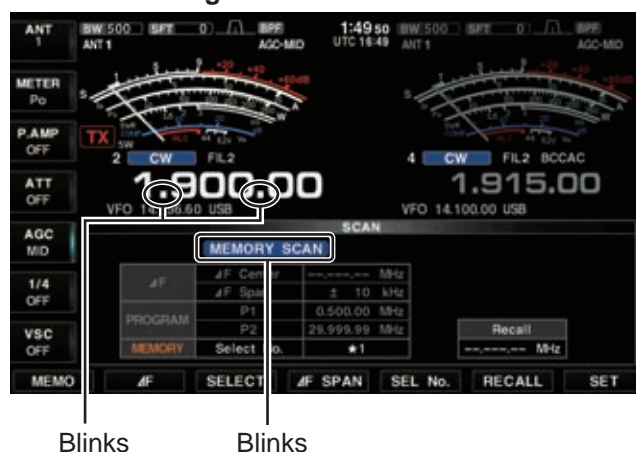

## Select memory scan

○ The Multi-function screens are OFF.

- ① Push [V/M].
  - Selects the Memory mode.
  - Pushing [V/M] toggles between the VFO and Memory modes.
- ② Push [SCAN](F).
  - The Scan screen is displayed.
- ③ Push [SEL No.](F) several times to select the Select scan number from “★1,” “★2,” “★3,” or “★1,2,3.”
- ④ Push [MEMO](F).
  - The Memory scan starts.
  - “**SELECT MEMORY SCAN**” and decimal points blink while scanning.
- ⑤ Push [SELECT](F).
  - The Select memory scan starts.
  - “**SELECT MEMORY SCAN**” blinks.
  - Push [SELECT](F) again to return to the Memory scan.
  - Push [MEMO](F) to cancel the scan.
  - Rotating [MAIN DIAL] also cancels the scan.
- ⑥ When the scan detects a signal, the scan stops, pauses or ignores it depending on the Scan Resume setting and the squelch status.

▨ Two or more memory channels must be designated as select memory channels, as well as the same Select scan number, for the Select memory scan to start.

### • While scanning



## ■ Setting Select memory channels

### ◇ Setting in the Scan screen

○ The Multi-function screens are OFF.

- ① Push [V/M].
  - Selects the Memory mode.
  - Pushing [V/M] toggles between the VFO and Memory modes.
- ③ Push [SCAN](F).
  - The Scan screen is displayed.
- ④ Select the desired memory channel to set as a Select memory channel.
  - The [▲] or [▼] keys and direct keypad selections can be used.
- ⑤ Push [SELECT](F) several times to set the memory channel as a Select memory ★1, ★2, ★3 or not.
- ⑥ Repeat steps ④ to ⑤ to program another memory channel as a Select memory channel, if desired.
- ⑦ Push [EXIT/SET]
  - Exits the Scan screen.

### • Setting the Select memory channels



### ◇ Setting in the Memory list screen

○ The Multi-function screens are OFF.

- ① Push [MEMORY](F)
  - The Memory list screen is displayed.
- ② Rotate [MAIN DIAL] while pushing [ROLL](F) or [SET](F) to select the desired memory channel.
  - The [▲] or [▼] keys and direct keypad selections can also be used.
- ④ Push [SELECT](F) several times to set the memory channel as a select memory ★1, ★2, ★3 or not.
- ⑤ Repeat steps ③ to ④ to program another memory channel as a Select memory channel, if desired.
- ⑥ Push [EXIT/SET].
  - Exits the Memory list screen.

### • Setting the Select memory channels



### ◇ Erasing the Select scan setting

○ The Multi-function screens are OFF.

- ① Push [MEMORY](F) to enter the Memory list screen, or push [SCAN](F) to enter the Scan screen.
- ② Hold down [SELECT](F) for 1 second to display the Memory select all clear window.
- ③ Push one of the following keys to clear all Select channel settings.
  - [★1](F): Clears all ★1 settings.
  - [★2](F): Clears all ★2 settings.
  - [★3](F): Clears all ★3 settings.
  - [★1,2,3](F): Clears all Select settings.
- ④ Push [EXIT/SET].
  - Exits the Memory list screen.

### • Erasing the Select memory channel scan settings



## ■ $\Delta F$ scan

- The Multi-function screens are OFF.
- ① Select the VFO mode or a Memory channel.
- ② Select the desired operating mode.
  - The operating mode can also be changed while scanning.
- ③ Push [SCAN](F) .
  - The Scan screen is displayed.
- ④ Push [ $\Delta F$  SPAN](F) to set the  $\Delta F$  span.
  - Selectable spans:  $\pm 5$  kHz,  $\pm 10$  kHz,  $\pm 20$  kHz,  $\pm 50$  kHz,  $\pm 100$  kHz,  $\pm 500$  kHz and  $\pm 1000$  kHz
- ⑤ Set the center frequency of the  $\Delta F$  scan.
- ⑥ Push [ $\Delta F$ ](F).
  - The  $\Delta F$  scan starts.
  - " **$\Delta F$  SCAN**" and decimal points blink while scanning.
  - Push [ $\Delta F$ ](F) to cancel the scan.
  - Rotate [MAIN DIAL] also cancels the scan.
  - Hold down [RECALL](F) for 1 second to recall the frequency that is set before starting the scan, if desired.
- ⑦ When the scan detects a signal, the scan stops, pauses or ignores it, depending on the Scan Resume setting and the squelch status.

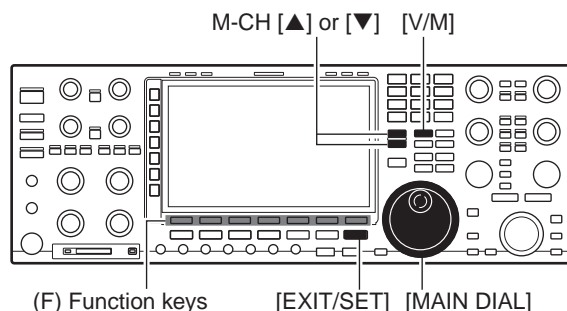

### • While scanning

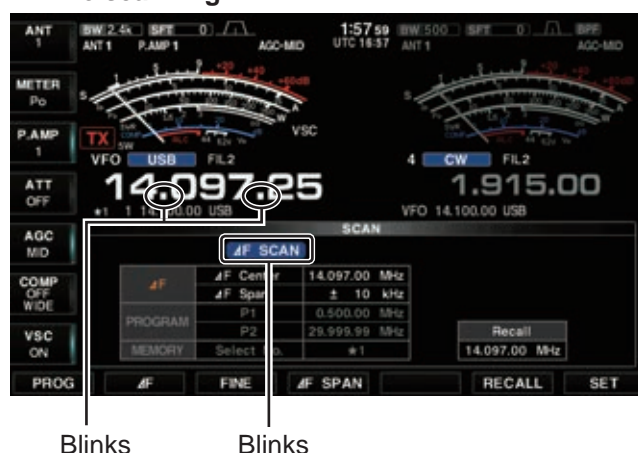

## ■ Fine $\Delta F$ scan

In fine scan (programmed or  $\Delta F$ ), the scan speed decreases when the squelch opens, but the transceiver keeps scanning. The scanning tuning step changes to 10 Hz when the squelch opens.

- The Multi-function screens are OFF.
- ① Push [SCAN](F).
  - The Scan screen is displayed.
- ② Set for  $\Delta F$  scan as described above.
- ③ Push [ $\Delta F$ ](F).
  - The  $\Delta F$  scan starts.
  - " **$\Delta F$  SCAN**" and decimal points blink while scanning.
- ④ Push [F-3•FINE].
  - The Fine  $\Delta F$  scan starts.
  - "**FINE  $\Delta F$  SCAN**" blinks.
  - Push [FINE](F) to cancel the Fine  $\Delta F$  scan.
  - Push [ $\Delta F$ ](F) to cancel the scan
  - Rotating [MAIN DIAL] also cancels the scan.
  - Hold down [RECALL](F) for 1 second to recall the frequency that is set before starting the scan, if desired.
- ⑤ When the scan detects a signal, the scan speed decreases but scan does not stop.

### • While scanning

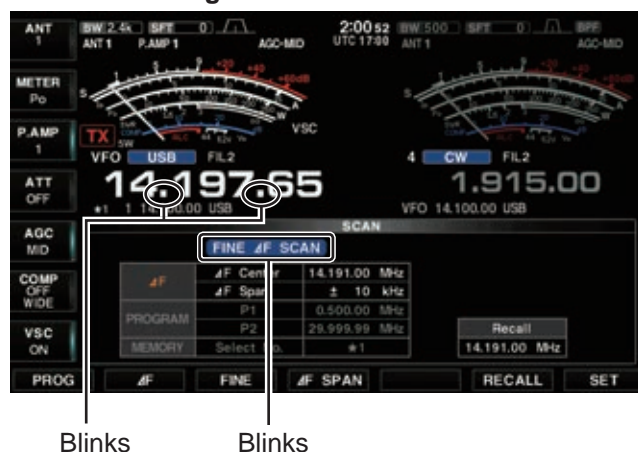



## ■ Tone scan

By monitoring a signal on an HF/6 m repeater input frequency, the transceiver can determine the tone frequency required to access the repeater.

- ① Set the frequency or memory channel to be checked for a tone frequency.
- ② Push the Mode key [AM/FM] several times to select the FM mode.
- ③ Hold down [TONE](▶) for 1 second.
  - The Tone frequency screen is displayed.
- ④ Push [▲](F) or [▼](F) to check the repeater tone frequency or tone squelch frequency.
- ⑤ Push [T-SCAN](F).
  - The Tone scan starts.
  - "SCAN" blinks while scanning.
- ⑥ When the tone frequency is detected, the tone scan pauses.
  - The tone frequency is set temporarily in the Tone memory. If desired, hold down [MW] for 1 second to overwrite the memory to permanently store the tone frequency.
  - The decoded tone frequency is used for the repeater tone frequency or tone squelch frequency.
- ⑦ To stop the scan, push [T-SCAN](F).
  - Hold down [DEF](F) for 1 second to select the default frequency.
- ⑧ Push [EXIT/SET].
  - Exits the Tone frequency screen.

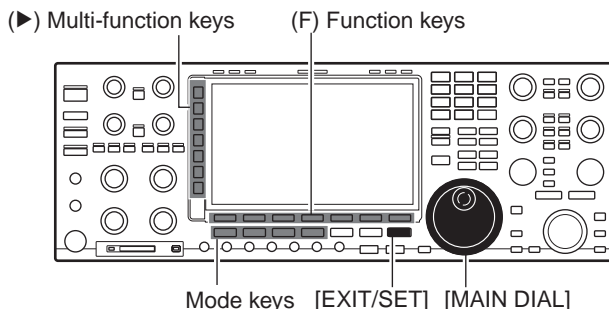

### • While scanning

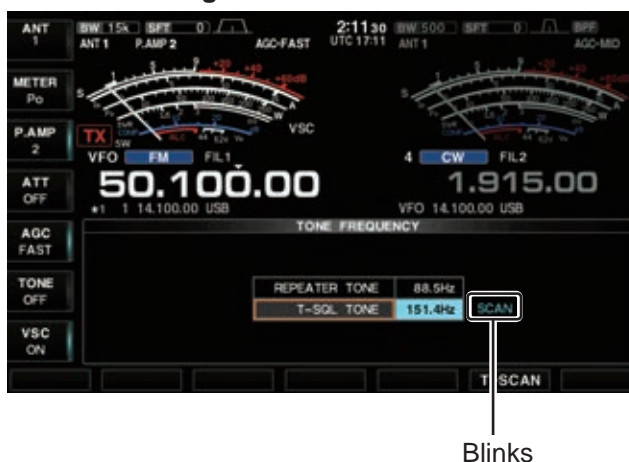

## ■ Voice Squelch Control function

This function is useful when you don't want unmodulated signals pausing or cancelling a scan. When the Voice Squelch Control function is activated, the scan pauses while the receiver checks the received signals for voice components. (The squelch does not open during this check.)

If a received signal includes voice components, and the tone of the voice components changes within 1 second, the scan is stopped and the squelch opens. If the received signal has no voice components, or the tone of the voice components does not change within 1 second, the scan resumes.

- ▶ While in a phone mode (SSB, AM or FM), push [VSC](▶) to turn the VSC (Voice Squelch Control) function ON or OFF.
  - "VSC" is displayed when the function is ON.

- ▨ • The VSC function can be used in any scan.
- ▨ • The VSC function resumes the scan on unmodulated signals, regardless of whether the Scan Resume function is set to ON or OFF.

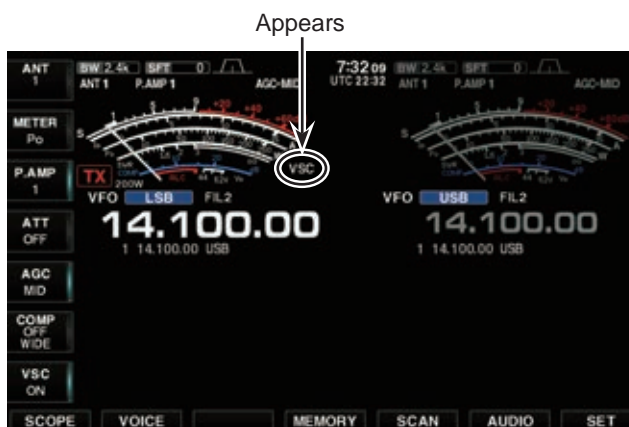
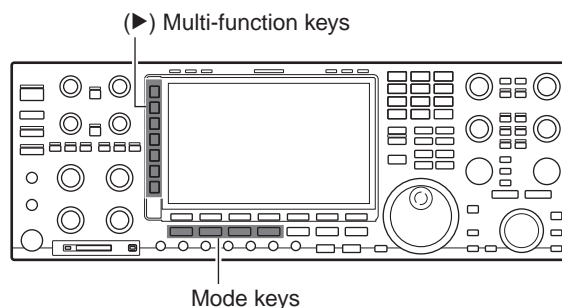

■ Antenna connection and selection .....	13-2
■ Receive Antenna-I/O selection .....	13-2
■ Antenna memory settings.....	13-3
◇ Selecting the antenna type .....	13-4
◇ Antenna selection mode .....	13-5
◇ Temporary memory .....	13-5
◇ Receive antenna I/O setting.....	13-6
■ About the Antenna tuner .....	13-7
■ Using the Antenna tuner operation .....	13-7
◇ If the tuner cannot tune the antenna .....	13-8

## ■ Antenna connection and selection

The transceiver has four antenna connectors for the HF/50 MHz bands, [ANT1], [ANT2], [ANT3], and [ANT4].

You can automatically select an antenna to your operating band if you assign an antenna to an operating band in advance.

⚡ **NOTE:** [ANT4] can be set as receive only.

### • Antenna selection mode: “Auto”

You can assign combinations of antenna connected to [ANT1] to [ANT4] and an operating band. After an antenna has been selected for use, the antenna is automatically selected whenever that band is used.

- ➡ Antenna selection mode (p. 13-5)
- ➡ Antenna memory settings (p. 13-3)

### • Antenna selection mode: “Manual”

You can push [ANT] (▶) to manually select a antenna connected to [ANT1] to [ANT4].

- ➡ Antenna selection mode (p. 13-5)
- ➡ Temporary memory (p. 13-5)

(▶) Multi-function keys

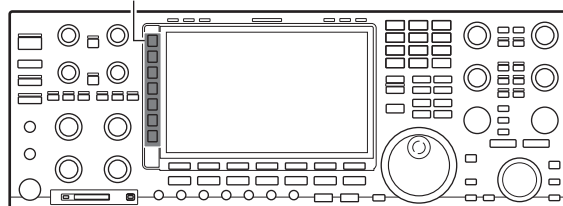

### • Antenna connection example

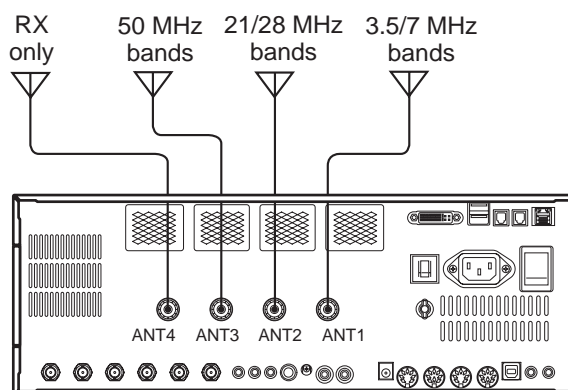

## ■ Receive Antenna-I/O selection

The transceiver has two independent receive antenna connectors, [RX-ANT A] and [RX-ANT B] on the rear panel.

You can connect a receive only antenna to IN, other receivers to OUT, and an external pre-amplifier/Filter between IN and OUT.

- ➡ Receive antenna I/O setting (p. 13-6)

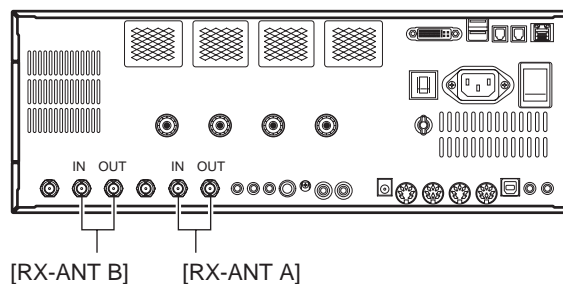



## ■ Antenna memory settings

This function stores the antenna connector number for each frequency band.

You can assign an antenna connected to [ANT1] to [ANT4] and the two [RX-I/O] and an operating band.

**NOTE:** [ANT1] is set as the default for all operating bands and no [RX-I/O] is used.

**Example: Assigning [ANT3] when you select the 14 MHz band.**

- ① Hold down the Multi-function [ANT](▶) key for 1 second.
  - The ANT screen is displayed.
- ② Push the [14] band key.
  - The 14 MHz band is selected.
- ③ Push the Multi-function [ANT](▶) key several times to select the "ANT3".
  - "★" appears.
- ④ Hold down [ANT MW](F) for 1 second to store the antenna selection into the antenna memory.
  - "★" disappears.
- ⑤ Push [EXIT/SET].
  - Exits the ANT screen.

**NOTE:** Push [RX-I/O] to change the settings without going to item step ④ above. The change can be stored in the antenna memory. (p. 13-6)

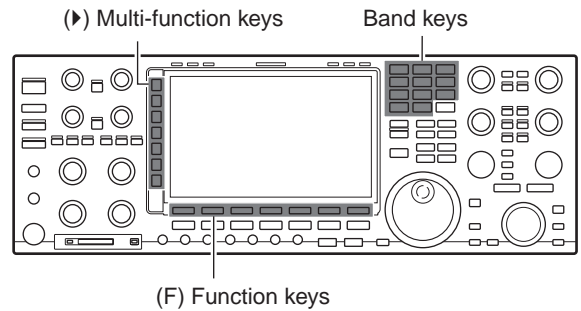

### • ANT screen

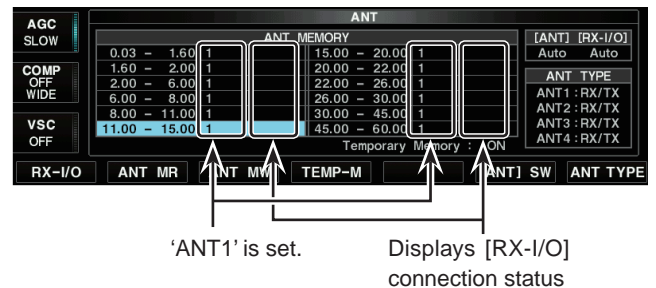

## 13 ANTENNA TUNER OPERATION

### ■ Antenna memory settings (Continued)

#### ◇ Selecting the antenna type

When no antenna is connected to [ANT2], [ANT3], and/or [ANT4], these antenna connectors can be deactivated— by deleting the antenna number from selection. This prevent the transceiver from accidentally transmitting into an empty antenna connector.

In addition, a receive-only antenna can be specified for [ANT4].

- ① Hold down the Multi-function [ANT](▶) key for 1 second.
  - The ANT screen is displayed.
- ② Push [ANT TYPE](F).
  - The ANT type screen is displayed.
- ③ Push [▲](F) or [▼](F) to select the desired antenna.
- ④ Rotate [MAIN DIAL] to set the desired antenna to TX/RX, RX (ANT4 only) or OFF.
  - OFF: Select when no antenna is connected.
  - TX/RX: Select when an antenna is connected. (Default)
  - RX: Select when a receive only antenna is connected. (available for the [ANT4] only)
- ⑤ Push [EXIT/SET].
  - Exits the ANT type screen.

#### ✓ For your information

- The “OFF” antennas cannot be selected with the Multi-function [ANT](▶) key operation, or with the antenna memory setting.
- When “RX” is set to for [ANT4], “1/R,” “2/R” and “3/R” selections will be added to the selection for both Multi-function [ANT](▶) key operation and the antenna memory setting. In these selections, use the antenna connected to [ANT1], [ANT2] and/or [ANT3] for transmission and using the antenna connected to [ANT4] for reception.

#### • Antenna type selection on the ANT screen

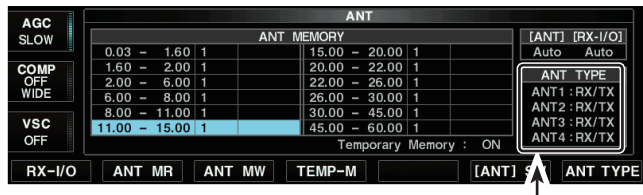

All antennas, connected to [ANT1]~[ANT4], are set as for 'TX/RX.'

#### • ANT type screen

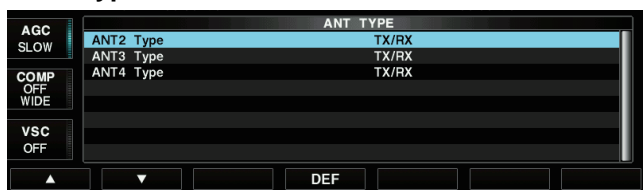

(▶) Multi-function keys

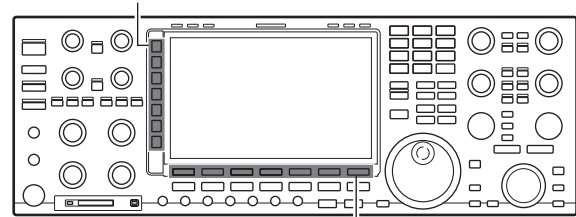

(F) Function keys

■ Antenna memory settings (Continued)

◇ Antenna selection mode

The automatic antenna selection (antenna memory) and the Multi-function [ANT](▶) key can be deactivated or you must manually select the desired antenna. You can set the desired selection in this mode.

- ① Hold down the Multi-function [ANT](▶) key for 1 second.
  - The ANT screen is displayed.
- ② Push [[ANT] SW](F) to set the antenna selection to “Auto Auto”, “Auto Manual” or “Manual Manual”.
  - Auto Auto: Uses the antenna memory. Selecting an antenna with the Multi-function [ANT](▶) key can also be made.
  - Auto Manual: Each antenna connector is selected according to the stored settings. A [RX-I/O] connector is selected with each pushing of [RX-I/O (F)] and is selected according regardless of stored settings.
  - Manual Manual: Deactivate the antenna memory function. Antenna can be selected only with the Multi-function [ANT] (▶) key operation. [RX-I/O] can be selected with [RX-I/O](F).
- ③ Push [EXIT/SET].
  - Exits the ANT screen.

◇ Temporary memory

The antenna temporary memory memorizes the manually selected antenna. The selected antenna will be recalled even if frequency band has been changed.

- ① Hold down the Multi-function [ANT](▶) key for 1 second.
  - The ANT screen is displayed.
- ② Push [TEMP-M](F).
  - “Temporary memory : ON” appears.
  - Push [TEMP-M](F) again to turn OFF.
- ③ Select the desired frequency band with a band key.
- ④ Push the Multi-function [ANT](▶) key to select the desired antenna.
  - “★” appears when a different antenna from the original is selected.
  - Push [ANT MR](F) to recall the original antenna. “★” disappears.
- ⑤ Push [EXIT/SET].
  - Exits the ANT screen.

**CAUTION:** Before transmitting with a manually selected antenna, make sure the selected antenna suits the operating frequency. Otherwise the transmitter may be damaged.

• Antenna selection mode

Push [[ANT] SW](F) to select the antenna selection mode.

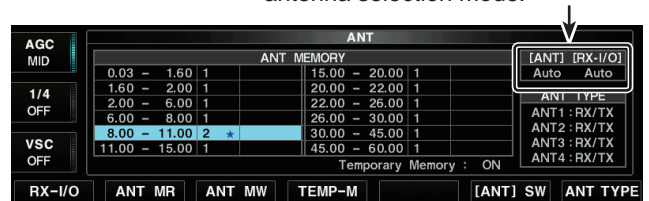

• Options of the Antenna selection mode



(▶) Multi-function keys

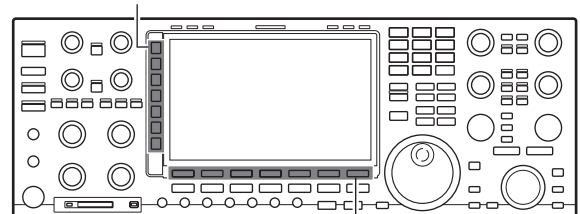

(F) Function keys

• When the temporary memory is ON.

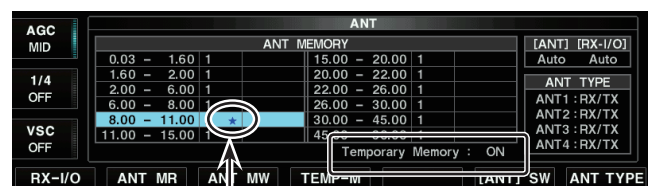

Appears when a different antenna from the original is selected.

The temporary memory is ON.

# 13 ANTENNA TUNER OPERATION

## ■ Antenna memory settings (Continued)

### ◇ Receive antenna I/O setting

A [RX-I/O] connector is automatically selected when you store the settings in the antenna memory. When you set the settings to [Auto manual] or [Manual Manual], an [RX-I/O] connector is commonly selected regardless of the selected band.

- ① Hold down the Multi-function [ANT](▶) key for 1 second.
  - The ANT screen is displayed.
- ② Push [RX-I/O](F) to activate the receive antenna connectors.
  - “RX-I/O” indicators appear when [RX-I/O A] and/or [RX-I/O B] is active.
  - Either “RX-I/O A” or “RX-I/O B” indicator appears under the “ANT” indicator.
  - When the RX-I/O is selected.

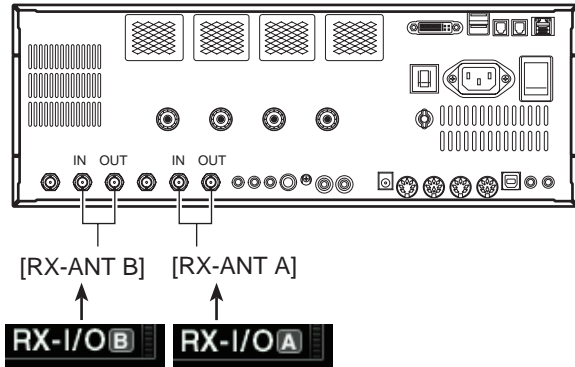
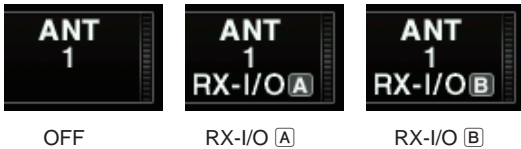

### • When the RX-I/O A is selected in the 10 MHz band

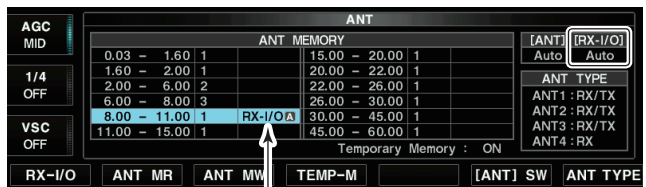

Pushing [RX-I/O](F) changes setting

### • When the RX-I/O is selected (1)

The setting is Displayed

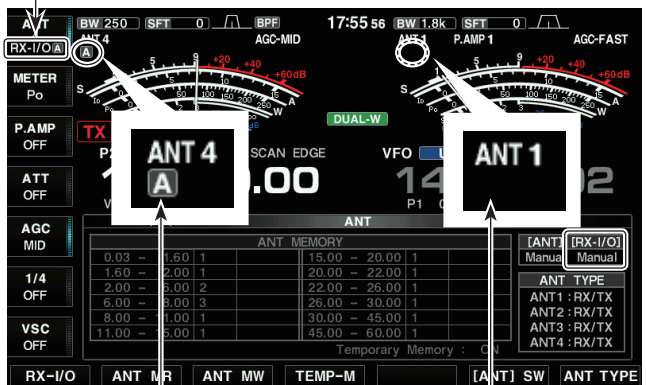

Set to RX-I/O A

Set to [RX-I/O] OFF

### • When the RX-I/O is selected (2)



When a common antenna is selected on the Main and Sub bands, different RX-I/O settings cannot be set.

Thus, the transceiver automatically sets the RX-I/O setting of the inoperating band to the correct setting, the same as the operating band.

### NOTE:

- When an external device is connected, and when a common antenna is set to the Main and Sus bands, different RX-I/O settings cannot be set.
- When different antennas are set to the Main and Sub bands, common RX-I/O settings cannot be set.
- When the SUB band is selected in the Dualwatch function OFF, you cannot change the RX-I/O setting. However, if you additionally turn ON the SPLIT function and holding down [XFC], you can change the RX-I/O setting.

## ■ About the Antenna tuner

The internal automatic antenna tuner automatically matches the transceiver to the connected antenna. After the tuner matches an antenna, the variable capacitor angles are memorized as a preset point for each frequency range (100 kHz steps). Therefore, when you change the frequency range, the variable capacitors are automatically preset to the memorized point.

**CAUTION:** NEVER transmit with the tuner ON when no antenna is connected. This will damage the transceiver. Be careful of the antenna selection.

## ■ Using the Antenna tuner operation

- ➔ Push [TUNER] to turn on the internal antenna tuner. The antenna is automatically tuned when the antenna SWR is higher than 1.5:1.
  - When the tuner is ON, the [TUNER] switch indicator lights white.
  - While tuning, the [TUNER] switch indicator blinks red.

### NOTE:

- NEVER transmit without an antenna properly connected to the selected antenna port.
- When 2 or more antennas are connected, select the antenna to be used with [ANT].
- If the SWR is higher than about 1.5:1 when tuning above 100 kHz on an antenna's preset point, hold down [TUNER] for 1 second to start manual tuning.
- The internal tuner may not be able to tune in the AM mode. In such cases, hold down [TUNER] for 1 second to manually tune.

### • MANUAL TUNING

During SSB operation at low voice levels, the internal tuner may not tune correctly. In such cases, manual tune the antenna.

- ➔ Hold down [TUNER] for 1 second, to start manual tuning.
  - A side tone is heard and the [TUNER] switch indicator blinks red while tuning.
  - If the tuner cannot reduce the SWR to less than 1.5:1 after 20 seconds of tuning, the [TUNER] switch indicator goes out.

### • AUTOMATIC TUNER START (HF bands only)

If you want to deactivate the tuner under conditions of VSWR 1.5:1 or less, use the auto tuner start function and turn the tuner OFF. This function activates the tuner automatically when the SWR exceeds 1.5:1.

This function is turned ON in the set mode. (p. 15-14).

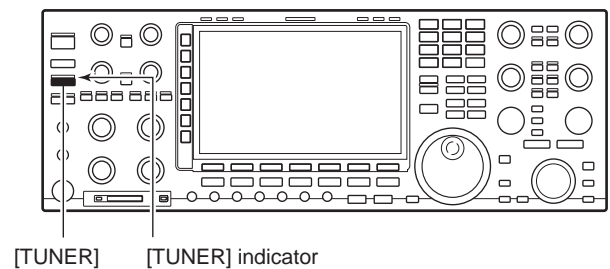

---

## 13 ANTENNA TUNER OPERATION

### ■ Antenna tuner operation (Continued)

#### • PTT TUNER START

The tuner is always activated when PTT is pushed after the frequency is changed (more than 1% from last-tuned frequency). This function removes the “hold down [TUNER],” and activates the tuner for the first transmission on a new frequency.

This function is turned ON in Set mode (p. 15-14).

#### • Antenna tuner in the IC-PW1

When using an external antenna tuner such as the IC-PW1's tuner, tune with the external antenna tuner, and turn OFF the transceiver's tuner. Otherwise, both tuners tune simultaneously and correct tuning may not be obtained.

See the instruction manual included with each antenna tuner for their respective operation.

### ◇ If the tuner cannot tune the antenna

Check the following and try again:

- the [ANT] connector selection
- the antenna connection and feedline
- the untuned antenna SWR (Less than 3:1 for the HF bands, Less than 2.5:1 for the 50 MHz band)
- the transmit power (8 W for the HF bands, 15 W for the 50 MHz band)
- the power source voltage/capacity

If the tuner cannot reduce the SWR to less than 1.5:1 after checking the above, perform the following:

- Repeat manual tuning several times.
- Tune with a 50  $\Omega$  dummy load and then retune the antenna.
- Turn power OFF and ON.
- Adjust the antenna feedline length (This is effective for higher frequencies in some cases.)
- Some antennas, especially for low bands, have a narrow bandwidth. These antennas may not tune at the edge of their bandwidth, therefore, tune such an antenna as follows:

**[Example]:** Suppose you have an antenna which has an SWR of 1.5:1 at 3.55 MHz and an SWR of 3:1 at 3.8 MHz.

- ① Set 3.55 MHz and hold down [TUNER] for 1 second to start manual tuning.
- ② Set 3.80 MHz and hold down [TUNER] for 1 second to start manual tuning.



- Time set mode ..... 14-2
  - ◇ Setting the Date ..... 14-2
  - ◇ Setting the Current time ..... 14-2
  - ◇ Setting the UTC Offset ..... 14-2
  - ◇ Selecting the CLOCK2 Function ..... 14-3
  - ◇ Setting the CLOCK2 UTC Offset..... 14-3
  - ◇ Entering the CLOCK2 Name ..... 14-3
  - ◇ Setting the NTP Function ..... 14-4
  - ◇ Setting the NTP Server address ..... 14-4
- Setting the Daily timer ..... 14-5
- Setting the Sleep timer ..... 14-6
- Timer operation ..... 14-6

## ■ Time set mode

This transceiver has a built-in calendar and 24-hour clock (accuracy of  $\pm 75$  seconds per month) with daily power ON/OFF timer functions. Before operating these timers, set the current date and time.

- The Multi-function screens are OFF:
- ① Push SET [F-7] then Time [F-5] to enter the Time set screen.
- ② Push [▲](F) or [▼](F) to select the item.
- ③ Rotate [MAIN DIAL] to set or select the desired value or setting.
- ④ Push [EXIT/SET] several times.
  - Exits the Time set screen.

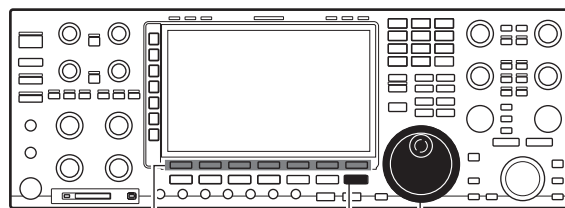

(F) Function keys [EXIT/SET] [MAIN DIAL]

### ◇ Setting the Date

Sets the Date.

- In the Time set screen:
- ① Push [▲](F) or [▼](F) to select the “Date” item.
- ② Push [◀▶](F) to select between the Year and Month/Day.
- ③ Rotate [MAIN DIAL] to enter the Year or Month/Day.
  - The Date setting and “DATE-set Push [SET]” blink.
- ④ Push [SET](F) to set the Date.
  - “DATE-set Push [SET]” disappears.

#### • When the “Date” item is selected



### ◇ Setting the Current time

Sets the local time.

- In the Time set screen:
- ① Push [▲](F) or [▼](F) to select the “Time (Now)” item.
- ② Rotate [MAIN DIAL] to enter the local time.
  - The Time setting and “TIME-set Push [SET]” blink.
- ③ Push [SET](F) to set the Time.
  - “TIME-set Push [SET]” disappears.

#### • When the “Time (Now)” item is selected

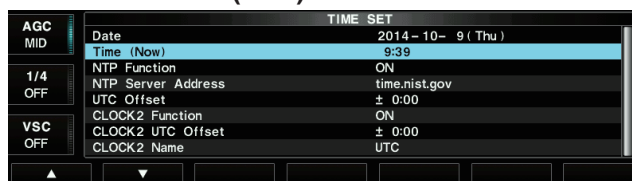

### ◇ Setting the UTC Offset

Set your local time offset from UTC between -14:00 and +14:00 in 5 minute steps.

- In the Time set screen:
- ① Push [▲](F) or [▼](F) to select the “UTC Offset” item.
- ② Rotate [MAIN DIAL] to set the offset time.
  - Hold down [DEF](F) for 1 second to select the default setting.

#### • When the “UTC Offset” item is selected



◇ **Selecting the CLOCK2 Function**

Turn the clock 2 display ON or OFF. (Default: ON)  
 Clock 2 is convenient to display the UTC or other country's local time.

- In the Time set screen:
- ① Push [▲](F) or [▼](F) to select the "CLOCK2 Function" item.
- ② Rotate [MAIN DIAL] to select the option.
  - ON: The Clock 2 time is displayed below the local time display. (Default)
  - OFF: The Clock 2 time is not displayed.

• When the "CLOCK2 Function" item is selected

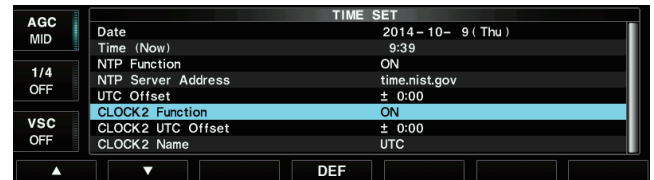

◇ **Setting the CLOCK2 UTC Offset**

Set the desired time offset for Clock 2's display from UTC between -14:00 and +14:00 in 5 minute steps.

- In the Time set screen:
- ① Push [▲](F) or [▼](F) to select the "CLOCK2 UTC Offset" item.
- ② Rotate [MAIN DIAL] to select the offset time.
  - Hold down [DEF](F) for 1 second to select the default setting.

• When the "CLOCK2 UTC Offset" item is selected



◇ **Entering the CLOCK2 Name**

Set a three character name for Clock 2. Upper case letters, lower case letters, numbers, some symbols, and spaces can be used.

- In the Time set screen:
- ① Push [▲](F) or [▼](F) to select the "CLOCK2 Name" item.
- ② Push [EDIT](F) to edit the Clock 2 name.
  - The cursor under the 1st character blinks.
- ③ Edit the desired character by rotating [MAIN DIAL] or by pushing a keypad key for a number entry.
  - Push [ABC](▶) or [abc](▶) to toggle between upper case letters and lower case letters.
  - Push [123](▶) or [Symbol](▶) to toggle between numbers and symbols.
  - Push [◀](F) or [▶](F) to move the cursor.
  - Push [DEL](F) to delete the selected character.
  - Push [SPACE](F) to input a space.
  - Pushing keypad, [0]–[9], can also enter numerals.
- ④ Push [EXIT/SET] to save the name.

• When the "CLOCK2 Name" item is selected

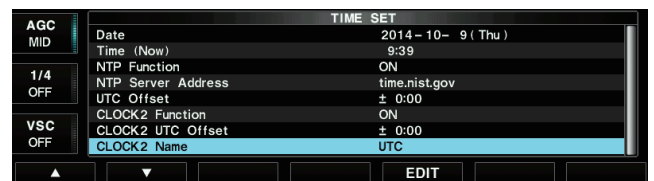

• When editing the "CLOCK2 Name" item

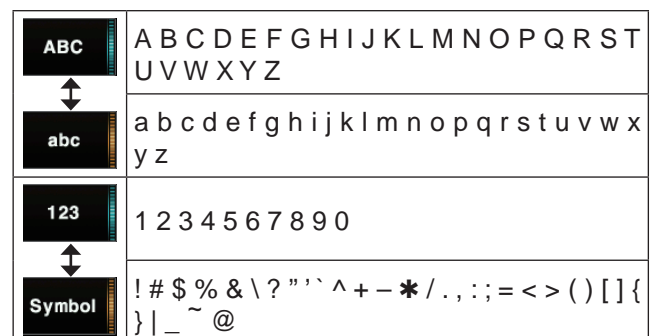
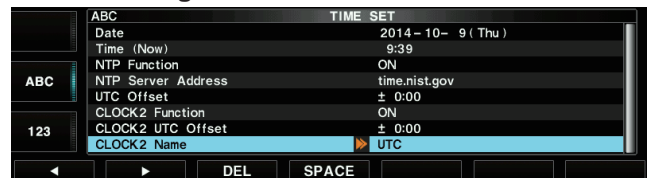

## ■ Time set mode (Continued)

### ◇ Setting the NTP Function

Turn the NTP (Network Time Protocol) function ON or OFF. (Default: ON)

The NTP function automatically synchronizes the internal clock with the time management server.

- To use this function, an internet connection and default gateway settings are necessary.

○ In the Time set screen:

- ① Push [▲](F) or [▼](F) to select the “NTP Function” item.
- ② Rotate [MAIN DIAL] to select “ON.”
  - The transceiver access the NTP server address that is set in the “NTP Server Address” item.

### ◇ Setting the NTP Server address

Set the NTP server address. (Default: time.nist.gov)

○ In the Time set screen:

- ① Push [▲](F) or [▼](F) to select the “NTP Server Address” item.
- ② Push [EDIT](F) to edit the address or its IP address.
  - The cursor under the 1st character blinks.
- ③ Edit the desired character by rotating [MAIN DIAL] or by pushing keypad for a number entry.
  - Push [ABC](▶) or [abc](▶) to toggle between upper case letters and lower case letters.
  - Push [123](▶) or [Symbol](▶) to toggle between numbers and symbols.
  - Push [◀](F) or [▶](F) to move the cursor.
  - Push [DEL](F) to delete the selected character.
  - Push [SPACE](F) to enter a space.
  - Pushing keypad, [0]–[9], can also enter numbers.
- ④ Push [EXIT/SET] to save the name.

#### NOTE:

The transceiver’s DHCP function is ON as the default to be easily assigned an IP address. Change the setting according to your network environment.  
 SET [F-7] > OTHERS [F-5] > DHCP (Valid after Reboot) (p. 15-19)

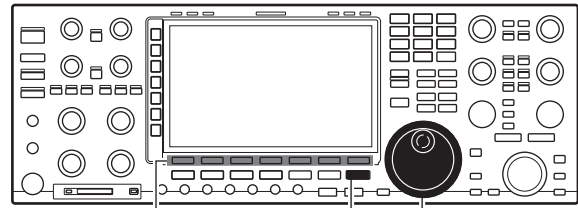

(F) Function keys [EXIT/SET] [MAIN DIAL]

#### • When the “NTP Function” item is selected



#### • When the “NTP Server Address” item is selected



#### • When editing the “NTP Server Address” item



ABC	A B C D E F G H I J K L M N O P Q R S T U V W X Y Z
abc	a b c d e f g h i j k l m n o p q r s t u v w x y z
123	1 2 3 4 5 6 7 8 9 0
Symbol	- .

## ■ Setting the Daily timer

The transceiver automatically turns power ON and/or OFF on the specified day and time, with the specified frequency settings in both the Main and Sub bands.

- The Multi-function screen is OFF:
- ① Hold down [TIMER] for 1 second.
  - The Timer set screen is displayed.
- ② Push one of [TIMER1](F) to [TIMER5](F) to select the desired timer.
- ③ Set the timer.
  - Push [◀](F) or [▶](F) to select the item.
  - Rotate [MAIN DIAL] to select the option.

Item	Option
ACT	Select the Daily timer action of ON or OFF. <ul style="list-style-type: none"> <li>• ON: The timer is enabled.</li> <li>• OFF: The timer is disabled.</li> </ul>
DAY	Select the desired day of the week. <ul style="list-style-type: none"> <li>• Select “-- --” to not specify the day of the week. In that case, the timer functions at next the time that is specified in the “ON” or “OFF” item.</li> <li>• To clear the day, push [CLR](F).</li> </ul>
REPEAT	Select the repeat setting ON or OFF. <ul style="list-style-type: none"> <li>• ON: The timer functions every selected day of the week or every day.</li> <li>• OFF: The timer functions only once. After the timer is activated, the transceiver automatically changes the “ACT” item to OFF.</li> </ul>
ON	Set the time that the transceiver powers ON. <ul style="list-style-type: none"> <li>• When using only the Power OFF timer, push [CLR](F) to select “-- --”.</li> </ul>
OFF	Set the time that the transceiver powers OFF. <ul style="list-style-type: none"> <li>• When using only the Power ON timer, push [CLR](F) to select “-- --”.</li> </ul>
MAIN	Select the Memory channel on the Main band when the Power ON timer is activated. <ul style="list-style-type: none"> <li>• To call up the last used Main band frequency, push [CLR](F) to select “-- --”.</li> </ul>
SUB	Select the Memory channel on the Sub band when the Power ON timer is activated. <ul style="list-style-type: none"> <li>• To call up the last used Sub band frequency, push [CLR](F) to select “-- --”.</li> </ul>

- “TIMER-set Push [SET]” blinks.
- ④ Push [SET](F) to save and set the timer.
  - “TIMER-set Push [SET]” disappears.
  - The timer indicator above the [TIMER] key lights white.
- ⑤ Repeat steps ② to ④ to set other timers, if desired.
- ⑥ Push [EXIT/SET].
  - Exits the Set screen.

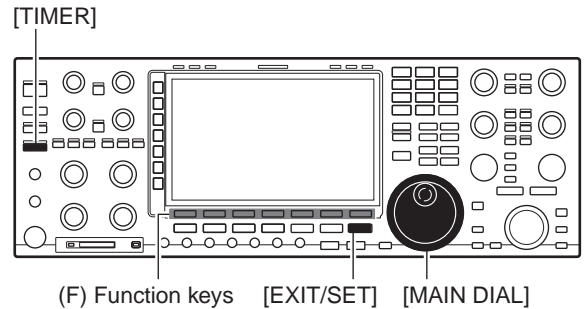

### • Timer screen



### • When the “TIMER1, ACT” item is selected

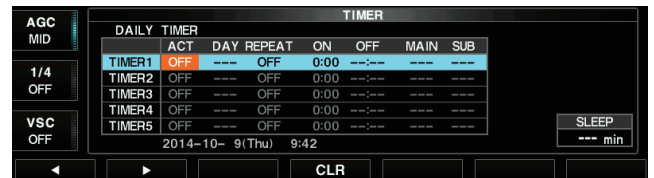

### • When the “TIMER1, SUB” item is selected

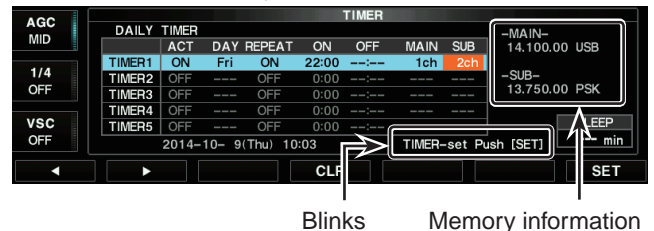

## ■ Setting the Sleep timer

The Sleep timer automatically turns OFF the transceiver power after the set period ends. The timer can be set to between 5 and 120 minutes, in 5 minute steps.

- The Multi-function screens are OFF:
- ① Hold down [TIMER] for 1 second.
  - The Timer set screen is displayed.
- ② Push [SLEEP](F) to enter the Sleep timer setting mode.
  - “- - -” blinks.
- ③ Rotate [MAIN DIAL] to set the desired time period.
  - “TIMER-set Push [SET]” blinks.
  - If desired, push [CLR](F) to clear the time.
  - If desired, push [EXIT/SET] to cancel the setting and to exit the Setting mode.
- ④ Push [SET](F) to save and set the timer.
  - The timer indicator above [TIMER] key lights white.
- ⑤ Push [EXIT/SET].
  - Exits the Set screen.
  - If desired, push [TIMER] to turn OFF the Timer function.
- ⑥ After the sleep timer period ends, the transceiver sounds 10 beeps and turns OFF .
  - The timer indicator blinks while beeping.

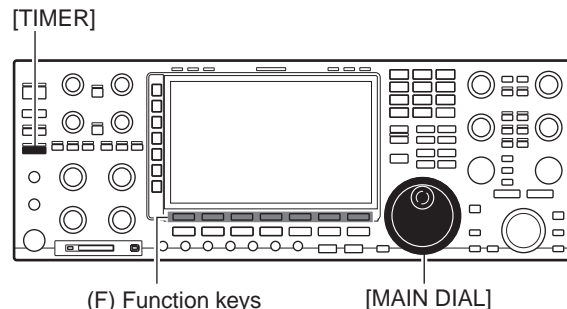

### • Timer screen

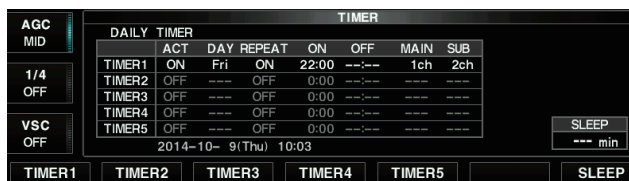

### • When setting the Sleeping timer



## ■ Timer operation

- Preset the Daily timer as described above.
- ① Push [TIMER] to turn ON the Timer function.
  - The timer indicator above this key lights white when the function is ON.
  - Push [TIMER] turns the Timer function ON or OFF.
- ② Hold down [POWER] for 1 second to turn OFF the power.
  - The timer indicator continuously lights.
- ③ When the set time arrives, the power is automatically turned ON.
- ④ After the power-off period ends, the transceiver sounds 10 beeps and turns OFF
  - The timer indicator blinks while beeping.

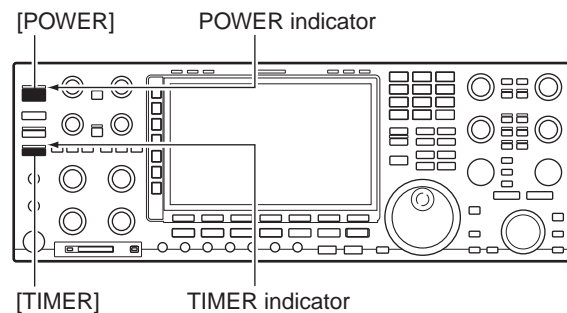

/// The Daily timer action in the Timer set screen must be set to ON to enable the timer operation, described in page 14-5 steps ③.



- Set mode description..... 15-2
  - ◇ Set mode operation ..... 15-2
  - ◇ Screen arrangement ..... 15-3
- Level set screen ..... 15-4
- ACC set screen ..... 15-6
- Display set screen ..... 15-10
- Time set screen ..... 15-12
- Others set screen ..... 15-13

## ■ Set mode description

The Set mode is used to make the infrequently changed settings.

The transceiver has the Level set mode, ACC set mode, Display set mode, Time set mode, Others set mode and SD/USB set mode (See section 10 for details).

### ◇ Set mode operation

- The Multi-function screens are OFF:
- ① Push [SET](F) to select the Set mode menu screen.
  - Holding down [EXIT/SET] for 1 second also selects the Set mode menu screen.
- ② Push [LEVEL](F), [ACC](F), [DISP](F), [TIME](F), [OTHERS](F) or [SD/USB](F) to enter a desired Set screen.
- ③ For Level, ACC, Display and Others set screens, push [EXPAND](F) to toggle the screen between expanded and normal.
- ④ Push [▲](F) or [▼](F) to select a desired item, and then rotate [MAIN DIAL] to adjust/select a desired value or option.
  - Pushing [◀▶](F) may be necessary for some items.
- ⑤ Push [EXIT/SET] twice.
  - Exits the Set screen.

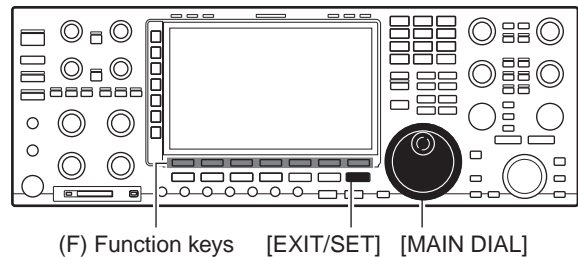

◇ Screen arrangement

The following screens can be selected from the Start up screen. Choose the desired screen using the following guide.

Pushing [EXIT/SET] several times returns to the Start up screen.

• Start up screen



F-7

• Set mode menu screen

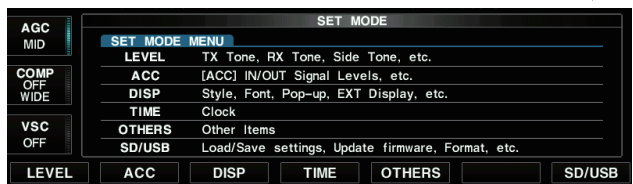

F-1 F-2 F-3 F-4 F-5 F-7

• Level set screen

(p. 15-4)

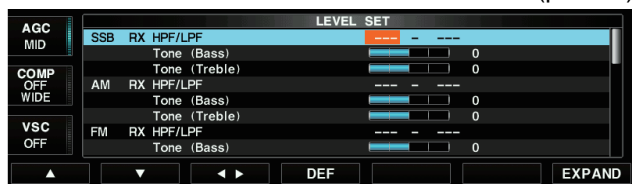

• ACC set screen

(p. 15-6)

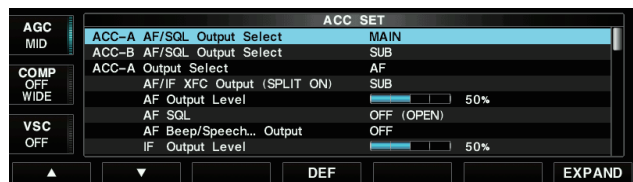

F-2

• Display set screen

(p. 15-10)



F-3

• Time set screen

(p. 15-12)



F-4

• Others set screen

(p. 15-13)

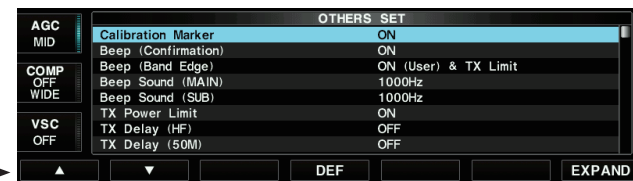

F-5

• SD/USB set screen

(See section 10 for details)

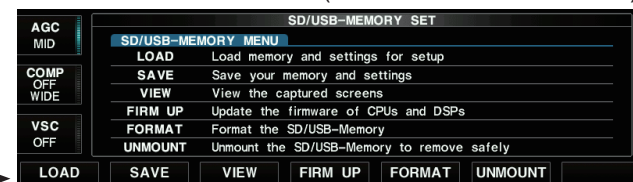

F-7

## ■ Level set screen

### SSB RX HPF/LPF (Default: --- - ---)

Sets the receive audio high-pass filter and low-pass filter cut-off frequency in 100 Hz steps.

Selectable ranges:

- HPF: Between 100 Hz and 2000 Hz
- LPF: Between 500 Hz and 2400 Hz

/// If this item is set, the [SSB RX Tone (Bass)] and [SSB RX Tone (Treble)] items cannot be set.

### SSB RX Tone (Bass) (Default: 0)

Sets the bass level of the receive audio tone in the SSB mode from -5 to +5.

### SSB RX Tone (Treble) (Default: 0)

Sets the treble level of the receive audio tone in the SSB mode from -5 to +5.

### AM RX HPF/LPF (Default: --- - ---)

Sets the receive audio high-pass filter or low-pass filter cut-off frequency in 100 Hz steps.

Selectable ranges:

- HPF: Between 100 Hz and 2000 Hz
- LPF: Between 500 Hz and 2400 Hz

/// If this item is set, the [AM RX Tone (Bass)] and [AM RX Tone (Treble)] items cannot be set.

### AM RX Tone (Bass) (Default: 0)

Sets the bass level of the receive audio tone in the AM mode from -5 to +5.

### AM RX Tone (Treble) (Default: 0)

Sets the treble level of the receive audio tone in the AM mode from -5 to +5.

### FM RX HPF/LPF (Default: --- - ---)

Sets the receive audio high-pass filter or low-pass filter cut-off frequency in 100 Hz steps.

Selectable ranges:

- HPF: Between 100 Hz and 2000 Hz
- LPF: Between 500 Hz and 2400 Hz

/// If this item is set, the [FM RX Tone (Bass)] and [FM RX Tone (Treble)] items cannot be set.

### FM RX Tone (Bass) (Default: 0)

Sets the bass level of the receive audio tone in the FM mode from -5 to +5.

### FM RX Tone (Treble) (Default: 0)

Sets the treble level of the receive audio tone in the FM mode from -5 to +5.

### CW RX HPF/LPF (Default: --- - ---)

Sets the receive audio high-pass filter or low-pass filter cut-off frequency in 100 Hz steps.

Selectable ranges:

- HPF: Between 100 Hz and 2000 Hz
- LPF: Between 500 Hz and 2400 Hz

### RTTY RX HPF/LPF (Default: --- - ---)

Sets the receive audio high-pass filter or low-pass filter cut-off frequency in 100 Hz steps.

Selectable ranges:

- HPF: Between 100 Hz and 2000 Hz
- LPF: Between 500 Hz and 2400 Hz

### PSK RX HPF/LPF (Default: --- - ---)

Sets the receive audio high-pass filter or low-pass filter cut-off frequency in 100 Hz steps.

Selectable ranges:

- HPF: Between 100 Hz and 2000 Hz
- LPF: Between 500 Hz and 2400 Hz

### SSB TX Tone (Bass) (Default: 0)

Sets the bass level of the transmit audio tone in the SSB mode from -5 to +5.

### SSB TX Tone (Treble) (Default: 0)

Sets the treble level of the transmit audio tone in the SSB mode from -5 to +5.

### AM TX Tone (Bass) (Default: 0)

Sets the bass level of the transmit audio tone in the AM mode from -5 to +5.

### AM TX Tone (Treble) (Default: 0)

Sets the treble level of the transmit audio tone in the AM mode from -5 to +5.

■ Level set screen (continued)

**FM TX Tone (Bass)** (Default: 0)

Sets the bass level of the transmit audio tone in the FM mode from -5 to +5.

**FM TX Tone (Treble)** (Default: 0)

Sets the treble level of the transmit audio tone in the FM mode from -5 to +5.

**SSB TBW (WIDE)** (Default: 100 – 2900)

Sets the transmission pass bandwidth to wide, by changing the lower and higher cut-off frequencies.

- Lower frequency: 100, 200, 300 and 500 Hz
- Higher frequency: 2500, 2700, 2800 and 2900 Hz

**SSB TBW (MID)** (Default: 300 – 2700)

Sets the transmission pass bandwidth to mid, by changing the lower and higher cut-off frequencies.

- Lower frequency: 100, 200, 300 and 500 Hz
- Higher frequency: 2500, 2700, 2800 and 2900 Hz

**SSB TBW (NAR)** (Default: 500 – 2500)

Sets the transmission pass bandwidth to narrow, by changing the lower and higher cut-off frequencies.

- Lower frequency: 100, 200, 300 and 500 Hz
- Higher frequency: 2500, 2700, 2800 and 2900 Hz

**SSB-D TBW** (Default: 300 – 2700)

Sets the transmission pass bandwidth for the SSB-D mode, by changing the lower and higher cut-off frequencies.

- Lower frequency: 100, 200, 300 and 500 Hz
- Higher frequency: 2500, 2700, 2800 and 2900 Hz

**Speech Level** (Default: 50%)

Sets the voice synthesizer audio output level.

- Range: 0 to 100% (in 1% steps)

**Side Tone Level** (Default: 50%)

Sets the CW side tone output level.

- Range: 0 to 100% (in 1% steps)

**Side Tone Level Limit** (Default: ON)

Turns the CW side tone level limiting ON or OFF.

**APF AF Level** (Default: 0 dB)

Sets the audio level for the audio peak filter in the CW mode.

- Range: 0 to +6 dB (in 1 dB steps)

**Beep Level** (Default: 50%)

Sets the beep output level.

- Range: 0 to 100% (in 1% steps)

**Beep Level Limit** (Default: ON)

Turns the beep output level limiting ON or OFF.

**Phones Level** (Default: 0)

Sets the audio output level ratio of the headphone and internal speaker between 0.60 and 1.40, in 0.01 steps.

**Phone L/R Mix** (Default: OFF)

Selects the headphone audio output.

- OFF: Outputs the Main band's audio from the left side, and Sub band's audio from the right side.
- ON: Outputs the mixed audio.

## ■ ACC set screen

### ACC-A AF/SQL Output Select

(Default: MAIN)

Selects the audio and squelch signals to output from [A ACC1] (Audio: pin 5, Squelch: pin 6) between the Main and Sub bands.

- MAIN: Main band's AF and squelch signals are output from [A ACC1].
- SUB: Sub band's AF and squelch signals are output from [A ACC1].

### ACC-B AF/SQL Output Select (Default: SUB)

Selects the audio and squelch signals to output from [B ACC1] (Audio: pin 5, Squelch: pin 6) between the Main and Sub bands.

- MAIN: Main band's audio and squelch signals are output from [B ACC1].
- SUB: Sub band's audio and squelch signals are output from [B ACC1].

### ACC-A Output Select

(Default: AF)

Selects the signal output from [A ACC1].

- AF: AF signal is output from [A ACC1].
- IF: A 12 kHz IF signal is output from [A ACC1].

### ACC-A AF/IF XFC Output (SPLIT ON)

(Default: SUB)

Selects the signal output from [A ACC1] while [XFC] is held down in the split operation.

- MAIN: Main band's AF/IF signal.
- SUB: Sub band's AF/IF signal.
- When "MAIN" is selected, the Sub band audio is muted.
- When "SUB" is selected, the Main band audio is muted.
- Setting the [ACC-A AF SQL Output Select] item is necessary.

### ACC-A AF Output Level

(Default: 50%)

Sets the AF output level of [A ACC1].

- Range: 0%–100% (in 1% steps)
- Approximately 200 mV at the 50% (default) setting.

### ACC-A AF SQL

(Default: OFF(OPEN))

Select the squelch behavior of [A ACC1].

- OFF(OPEN): The squelch is always opened regardless of the transceiver's squelch condition.
- ON: The squelch opens and closes, according to the transceiver's squelch condition.

### ACC-A AF Beep/Speech... Output

(Default: OFF)

Sets the Beep and Speech audio output condition. ([A ACC1])

- OFF: Beep and Speech audio are not output from [A ACC1].
- ON: Beep and Speech audio are output from [A ACC1].
- Setting the [ACC-A AF SQL Output Select] item is necessary.
- The beep level is limited when the [Beep Level Limit] is ON.
- The side tone level is limited when the [Side Tone Level Limit] is ON.

### ACC-A IF Output Level

(Default: 50%)

Sets the IF output level of [A ACC1].

- Range: 0%–100% (in 1% steps)

### ACC-B Output Select

(Default: AF)

Selects the signal output from [B ACC1].

- AF: AF signal is output from [B ACC1].
- IF: IF signal is output from [B ACC1].

### ACC-B AF/IF XFC Output (SPLIT ON)

(Default: SUB)

Selects the signal output from [B ACC1] while [XFC] is held down in the split operation.

- MAIN: Main band's AF/IF signal.
- SUB: Sub band's AF/IF signal.
- When "MAIN" is selected, the Sub band audio is muted.
- When "SUB" is selected, the Main band audio is muted.
- Setting the [ACC-B AF SQL Output Select] item is necessary.

### ACC-B AF Output Level

(Default: 50%)

Sets the AF output level of [B ACC1], within 0 to 100% in 1% steps.

- At 50%, the output level is approximately 200 mV.

### ACC-B AF SQL

(Default: OFF(OPEN))

Select the squelch behavior of [B ACC1].

- OFF(OPEN): The squelch is always opened regardless of the transceiver's squelch condition.
- ON: The squelch opens and closes, according to the transceiver's squelch condition.



## ■ ACC set screen (continued)

### ACC-B AF Beep/Speech... Output

(Default: OFF)

Select "ON" to output the Beep and Speech audio from [B ACC1].

- OFF: Beep and Speech audio are not output from [B ACC1].
- ON: Beep and Speech audio are output from [B ACC1].
- Setting the [ACC-B AF SQL Output Select] item is necessary.
- The beep level is limited when the [Beep Level Limit] is ON.
- The side tone level is limited when the [Side Tone Level Limit] is ON.

### ACC-B IF Output Level

(Default: 50%)

Sets the IF output level of [B ACC1].

- Range: 0%–100% (in 1% steps)

### S/PDIF Output Select

(Default: AF)

Selects the signal output from [S/P DIF].

- AF: AF signal is output from [S/P DIF].
- IF: IF signal is output from [S/P DIF].

### S/PDIF AF/IF XFC Output (SPLIT ON)

(Default: SUB)

Selects the signal output from [S/P DIF] while [XFC] is held down in the split operation.

- MAIN: Main band's AF/IF signal.
- SUB: Sub band's AF/IF signal.
- When "MAIN" is selected, the Sub band audio is muted.
- When "SUB" is selected, the Main band audio is muted.

### S/PDIF AF Output Level

(Default: 50%)

Sets the [S/P DIF] output level.

- Range: 0 to 100% (in 1% steps)

### S/PDIF AF SQL

(Default: OFF(OPEN))

Select the squelch behavior of [S/P DIF].

- OFF(OPEN): The squelch is always opened regardless of the transceiver's squelch condition.
- ON: The squelch opens and closes, according to the transceiver's squelch condition.

### S/PDIF AF Beep/Speech... Output

(Default: OFF)

Select "ON" to output the Beep and Speech audio from [S/P DIF].

- OFF: Beep and Speech audio are not output from [S/P DIF].
- ON: Beep and Speech audio are output from [S/P DIF].

### S/PDIF IF Output Level

(Default: 50%)

Sets the IF output level of [S/P DIF].

- Range: 0 to 100% (in 1% steps)

### USB Output Select

(Default: AF)

Selects the [USB B] output signal.

- AF: AF signal is output from [USB B].
- IF: IF signal is output from [USB B].

### USB AF/IF XFC Output (SPLIT ON)

(Default: SUB)

Selects the signal output from [USB B] while [XFC] is held down in the split operation.

- MAIN: Main band's AF/IF signal.
- SUB: Sub band's AF/IF signal.
- When "MAIN" is selected, the Sub band audio is muted.
- When "SUB" is selected, the Main band audio is muted.

### USB AF Output Level

(Default: 50%)

Sets the [USB B] output level.

- Range: 0 to 100% (in 1% steps)

### USB AF SQL

(Default: OFF(OPEN))

Select the squelch behavior of [USB B].

- OFF(OPEN): The squelch is always opened regardless of the transceiver's squelch condition.
- ON: The squelch opens and closes, according to the transceiver's squelch condition.

### USB AF Beep/Speech... Output

(Default: OFF)

Select "ON" to output the Beep and Speech audio from [USB B].

- OFF: Beep and Speech audio are not output from [USB B].
- ON: Beep and Speech audio are output from [USB B].
- The beep level is limited when the [Beep Level Limit] is ON.
- The side tone level is limited when the [Side Tone Level Limit] is ON.

## ■ ACC set screen (continued)

### **USB IF Output Level** (Default: 50%)

Sets the [USB B] output level.

- Range: 0%–100% (in 1% steps)

### **LAN Output Select** (Default: AF)

Selects the signal output from [LAN].

- AF: AF signal is output from [LAN].
- IF: IF signal is output from [LAN].

### **LAN AF SQL** (Default: ON)

Select the squelch behavior of [LAN].

- OFF(OPEN): The squelch is always opened regardless of the transceiver's squelch condition.
- ON: The squelch opens and closes, according to the transceiver's squelch condition.

### **ACC-A MOD Level** (Default: 50%)

Sets the modulation input level of [A ACC1].

- Range: 0%–100% (in 1% steps)
- Approximately 200 mV at the 50% (default) setting.

### **ACC-B MOD Level** (Default: 50%)

Sets the modulation input level of [B ACC1].

- Range: 0%–100% (in 1% steps)
- Approximately 200 mV at the 50% (default) setting.

### **S/PDIF MOD Level** (Default: 50%)

Sets the modulation input level of [S/P DIF].

- Range: 0%–100% (in 1% steps)

### **USB MOD Level** (Default: 50%)

Sets the modulation input level of [USB].

- Range: 0%–100% (in 1% steps)

### **LAN MOD Level** (Default: 50%)

Sets the modulation input level of [LAN].

- Range: 0%–100% (in 1% steps)

### **DATA OFF MOD** (Default: MIC,ACC-A,ACC-B)

Selects the connector(s) to input the modulation signal when the data mode is OFF.

- MIC: Use the signal from [MIC].
- ACC-A: Use the signal from [A ACC1] (pin 4).
- ACC-B: Use the signal from [B ACC1] (pin 4).
- MIC,ACC-A: Use the signal from [MIC] and [A ACC1] (pin 4).
- MIC,ACC-B: Use the signal from [MIC] and [B ACC1] (pin 4).
- ACC-A,ACC-B: Use the signal from [A ACC1] and [B ACC1] (pin 4).
- MIC,ACC-A,ACC-B: Use the signal from [MIC], [A ACC1] and [B ACC1] (pin 4).
- USB: Use the signal from [USB].
- S/P DIF: Use the signal from [S/P DIF].
- LAN: Use the signal from [LAN].
- MIC,USB : Use the signal from [MIC] and [USB].

### **DATA1 MOD** (Default: ACC-A)

Selects the connector(s) to input the modulation signal when the data 1 mode (D1) is ON.

- MIC: Use the signal from [MIC].
- ACC-A: Use the signal from [A ACC1] (pin 4).
- ACC-B: Use the signal from [B ACC1] (pin 4).
- MIC,ACC-A: Use the signal from [MIC] and [A ACC1] (pin 4).
- MIC,ACC-B: Use the signal from [MIC] and [B ACC1] (pin 4).
- ACC-A,ACC-B: Use the signal from [A ACC1] and [B ACC1] (pin 4).
- MIC,ACC-A,ACC-B: Use the signal from [MIC], [A ACC1] and [B ACC1] (pin 4).
- USB: Use the signal from [USB].
- S/P DIF: Use the signal from [S/P DIF].
- LAN: Use the signal from [LAN].
- MIC,USB : Use the signal from [MIC] and [USB].

## ■ ACC set screen (continued)

### DATA2 MOD (Default: ACC-B)

Selects the connector(s) to input the modulation signal when data 2 mode (D2) is ON.

- MIC: Use the signal from [MIC].
- ACC-A: Use the signal from [A ACC1] (pin 4).
- ACC-B: Use the signal from [B ACC1] (pin 4).
- MIC,ACC-A: Use the signal from [MIC] and [A ACC1] (pin 4).
- MIC,ACC-B: Use the signal from [MIC] and [B ACC1] (pin 4).
- ACC-A,ACC-B: Use the signal from [A ACC1] and [B ACC1] (pin 4).
- MIC,ACC-A,ACC-B: Use the signal from [MIC], [A ACC1] and [B ACC1] (pin 4).
- USB: Use the signal from [USB].
- S/P DIF: Use the signal from [S/P DIF].
- LAN: Use the signal from [LAN].
- MIC,USB : Use the signal from [MIC] and [USB].

### DATA3 MOD (Default: ACC-A,ACC-B)

Selects the connector(s) to input the modulation signal when the data 3 mode (D3) is ON.

- MIC: Use the signals from [MIC].
- ACC-A: Use the signal from [A ACC1] (pin 4).
- ACC-B: Use the signal from [B ACC1] (pin 4).
- MIC,ACC-A: Use the signal from [MIC] and [A ACC1] (pin 4).
- MIC,ACC-B: Use the signal from [MIC] and [B ACC1] (pin 4).
- ACC-A,ACC-B: Use the signal from [A ACC1] and [B ACC1] (pin 4).
- MIC,ACC-A,ACC-B: Use the signal from [MIC], [A ACC1] and [B ACC1] (pin 4).
- USB: Use the signal from [USB].
- S/P DIF: Use the signal from [S/P DIF].
- LAN: Use the signal from [LAN].
- MIC,USB : Use the signal from [MIC] and [USB].

### ACC-A BAND Voltage Output (Default: TX)

Selects the operating band voltage output from [A ACC2] (pin 4).

- MAIN: Outputs the band signal displayed on the Main band.
- SUB: Outputs the band signal displayed on the Sub band.
- TX: Outputs the band signal, that can be transmitted.

### ACC-B BAND Voltage Output (Default: TX)

Selects the operating band voltage output from [B ACC2] (pin 4).

- MAIN: Outputs the band signal displayed on the Main band.
- SUB: Outputs the band signal displayed on the Sub band.
- TX: Outputs the band signal, that can be transmitted.

### SEND Relay Type (Default: MOS-FET)

Selects the switching relay type for [RELAY]. Be careful to select the suitable relay type, especially when connecting a non-Icom linear amplifier.

- Reed: Use a mechanical relay. (16 V DC/0.5 A maximum)
- MOS-FET: Use a semiconductor relay. (200 mA/250 V maximum)

### External Meter Output (M) (Default: Auto)

Selects the parameter (Main readout) to output to an external meter.

- Auto: Outputs the receiving signal strength level during receive, and outputs the selected level (selected with [METER]), during transmit.
- S(MAIN): Outputs the receiving signal strength level during receive.
- Po: Outputs the transmitting power level during transmit.
- SWR: Outputs the VSWR level during transmit.
- ALC: Outputs the ALC level during transmit.
- COMP: Outputs the compression level during transmit.
- V<sub>D</sub>: Outputs the drain voltage of the final amplifier MOS-FETs.
- I<sub>D</sub>: Outputs the drain current of the final amplifier MOS-FETs.

■ ACC set screen (continued)

**External Meter Output (S)** (Default: Auto)

Selects the parameter (Sub readout) to output an external meter.

- Auto: Outputs the receiving signal strength level during receive, and outputs the selected level (selected with [METER]), during transmit.
- S(SUB): Outputs the receiving signal strength level during receive.
- Po: Outputs the transmitting power level during transmit.
- SWR: Outputs the VSWR level during transmit.
- ALC: Outputs the ALC level during transmit.
- COMP: Outputs the compression level during transmit.
- V<sub>D</sub>: Outputs the drain voltage of the final amplifier MOS-FETs.
- I<sub>D</sub>: Outputs the drain current of the final amplifier MOS-FETs.

**External Meter Level (M)** (Default: 50%)

Sets the output level to the external meter (Main band).

- Range: 0%–100% (in 1% steps)
- Approximately 1.2 V (full-scale) at the 50% (default) setting. (impedance: 4.7 kΩ)

**External Meter Level (S)** (Default: 50%)

Sets the output level to the external meter (Sub band).

- Range: 0%–100% (in 1% steps)
- Approximately 1.2 V (full-scale) at the 50% (default) setting. (impedance: 4.7 kΩ)

**REF IN/OUT** (Default: OFF)

Selects the transceiver's reference frequency signal source.

- IN: Uses an external reference signal. Turn OFF the power, and then turn ON to make the setting effective.

**NOTE:** If the applied reference signal is off frequency, or no signal is applied, the transceiver will not properly operate. In that case, select "OFF" or "OUT," and then reboot the transceiver.

- OFF: Does not input/output the reference signal.
- OUT: Outputs the internal reference signal to the connected equipment(s).

**REF Adjust**

Adjusts the internal reference frequency.

- Range: 0%–100% (in 1% steps)

**NOTE:** The default setting differs slightly, depending on the transceiver.

■ Display set screen

**LCD Unit Bright** (Default: 50%)

Adjusts the LCD brightness.

- Range: 0 (dark) to 100% (bright) (in 1% steps)

**Backlight (Switches)** (Default: 80)

Adjusts the key backlight brightness.

- Range: 1 (dark) to 100 (bright) (in 1 steps)

**Display Type**

(Default for IC-7850: 50th Anniversary)

(Default for IC-7851: A)

Sets the display type to A or B.

- The IC-7850 can be selected the 50th Anniversary type.

**Display Font** (Default: Basic (1))

Selects the font for the frequency readout.

- Options: Basic (1), Basic (2), Basic (3), Italic (1), Italic (2), Italic (3), Round (1), Round (2), Round (3)

**Meter Response** (Default: MID)

Sets the meter needle response speed to SLOW, MID or FAST.

**Meter Type (Normal Screen)**

(Default: Standard)

Sets the S/RF meter type for the normal display to Standard, Edgewise or Bar.

**Meter Type (Expand Screen)** (Default: Bar)

Sets the S/RF meter type for the expanded display to Standard, Edgewise or Bar.

**Meter Peak Hold (Bar)** (Default: ON)

Turns the meter peak hold function ON or OFF.

**Memory Name** (Default: ON)

Turns the memory name indication in the memory mode ON or OFF.

- ON: The programmed memory name is displayed above the frequency display.
- OFF: Memory name is not displayed, even if entered.

■ Display set screen (continued)

**APF-Width Popup (APF OFF⇒ON)**

(Default: ON)

Turns the APF filter width display ON or OFF.

**MN-Q Popup (MN OFF⇒ON)** (Default: ON)

Turns the notch filter bandwidth display ON or OFF.

**Screen Saver Function** (Default: 60 min)

Turns the screen saver function ON (Timer: 15, 30 or 60 minutes) or OFF.

**Screen Saver Type** (Default: Bounce)

Sets the screen saver type to Bounce, Rotation, Twist or Sleep.

**External Display** (Default: OFF)

Select "ON" when using an external display.

**External Display Resolution**

(Default: 800x480)

Select the screen resolution of the external display.

- Options: 800x480, 800x600

**External Display Frame Rate Shift**

(Default: OFF)

Sets the frame rate of the external display.

- Do not change this setting, unless it is necessary.

**External Display Sync Pulse** (Default: H)

Sets the suitable sync pulse level for an external display to H (high) or L (low).

**Opening Message** (Default: ON)

Turns the opening message ON or OFF.

**My Call**

Sets an introductory text displayed as the opening message, up to 10 characters. (example: your call sign)

• **Usable characters:**

Characters (a–z, A–Z, 0–9) and symbols (+ – , @)

- Push [EDIT](F) to enter the edit mode.
- Push [ABC] or [abc] to toggle the character type between upper case and lower case letters.
- Push [123] or [Symbol] to toggle the character type between numbers and symbols.
- Rotate [MAIN DIAL] to select a character.
- Push [◀](F) to move the cursor to the left, push [▶](F) to move the cursor right.
- Push [DEL](F) to delete the selected character.
- Push [EXIT/SET] to cancel and exit the edit mode.
- Push [SET](F) to save.

## ■ Time set screen

### **Date** (Default: 2000)

Set the date (Year/Month/Day).  
(The day of the week is automatically set.)

- Range: Year 2000–2099,  
Month/Day 1-1 to 12-31

### **Time (Now)** (Default: 0:00)

Set the current time.  
(The time is displayed in the 24 hours format.)

- Sets the current time.

### **NTP Function** (Default: ON)

Automatically obtains the current time from the NTP server.

- OFF: Turn OFF the function.
- ON: Use the function. (The internet access is necessary.)

### **NTP Server Address** (Default: time.nist.gov)

Sets the NTP server address.  
⚡ Do not change this setting, unless it is necessary.

### **UTC Offset** (Default: ±0:00)

Sets the UTC offset time.  
• Range: –14:00 to +14:00 (in five minute steps)

### **CLOCK 2 Function** (Default: ON)

Turns Clock 2 ON or OFF.

- OFF: Disable Clock 2.
- ON: Enable Clock 2.

### **CLOCK 2 UTC Offset** (Default: ±0:00)

Sets the UTC offset time for Clock 2.

- Range: –14:00 to ±0.00 to +14:00
- To set the UTC time, select "±0:00."

### **CLOCK 2 Name** (Default: UTC)

Assign the name to the CLOCK 2.  
• Enter name of up to three characters.



## ■ Others set screen

### **Calibration Marker** (Default: OFF)

Turns the reference frequency calibration marker ON or OFF.

- OFF: Turns OFF the marker.
- ON: Turns ON the marker.

### **Beep (Confirmation)** (Default: ON)

Turns the confirmation beep ON or OFF.

- OFF: Turns OFF the beep.
- ON: Sounds the beep when a key is pushed.
  - ▨ If the Beep Level is set to "0%" on the Level set screen, no beep sounds.

### **Beep (Band Edge)** (Default: ON (Default))

Turns the band edge beep ON or OFF.

▨ If the Beep Level is set to "0%" on the Level set screen, no beep sounds.

- OFF: Turn OFF the band edge beep.
- ON(Default): Beep sounds on the band edge.
- ON(User): The beep, which is selected in the Band edge screen, sounds. (p. 4-15, P4-16)
- ON(User) & TX Limit: The beep, which is selected in the Band edge screen, sounds. The transmitting frequency is limited in the range between upper and lower band edge. (p. 4-15, p. 4-16)

### **Beep Sound (MAIN)** (Default: 1000Hz)

Sets the key-touch beep frequency on the Main band.

- Range: 500 Hz–2000 Hz (in 10 Hz steps)

▨ If the Beep Level is set to "0%" on the Level set screen no beep sounds.

### **Beep Sound (SUB)** (Default: 1000Hz)

Sets the key-touch beep frequency on the Sub band.

- Range: 500Hz–2000Hz (in 10 Hz steps)

▨ If the Beep Level is set to "0%" on the Level set screen no beep sounds.

### **TX Power Limit** (Default: ON)

Turns the TX power limit function ON or OFF.

- OFF: Turn OFF the function.
- ON: Limits the TX power for each mode and band.

▨ The TX power limit screen is displayed when [LIMIT] is pushed. Adjust the power limit to between <5 W and 200 W for each selected band.

### **TX Delay (HF)** (Default: OFF)

Sets the TX delay time on the HF bands.

- Options: OFF, 10ms, 15ms, 20ms, 25ms, 30ms

▨ If the connected equipment's rise time is slower than that of the transceiver, a reflected wave is produced and it may damage the transceiver. To prevent this, set the appropriate delay time so that no reflected wave is produced.

- Select "OFF" for no rise speed.

### **TX Delay (50M)** (Default: OFF)

Sets the TX delay time on the 50 MHz band.

- Options: OFF, 10ms, 15ms, 20ms, 25ms, 30ms

▨ If the connected equipment's rise time is slower than that of the transceiver, a reflected wave is produced and it may damage the transceiver. To prevent this, set the appropriate delay time so that no reflected wave is produced.

- Select "OFF" for no rise speed.

### **Time-Out Timer (CI-V)** (Default: OFF)

Sets the Time-out Timer for CI-V operation.

This setting is valid only transmitting initiated by a CI-V command and pushing [TRANSMIT].

- Options: OFF, 3, 5, 10, 20 or 30 minutes

▨ Select "OFF" for no time limit.

### **Quick Dualwatch** (Default: ON)

Turns the Quick Dualwatch function ON or OFF.

- OFF: Turn OFF the function.
- ON: Turn ON the function.

### **Quick SPLIT** (Default: ON)

Turns the Quick Split function ON or OFF.

- OFF: Turn OFF the function.
- ON: Turn ON the function.

## ■ Others set screen (continued)

**FM SPLIT Offset (HF)** (Default: -0.100MHz)

Sets the offset frequency for the Split function in the FM mode on the HF bands.

- Range: -9.999MHz to +9.999MHz (in 1 kHz steps)

**FM SPLIT Offset (50MHz)** (Default: -0.500MHz)

Sets the offset frequency for the Split function in the FM mode on the 50 MHz band.

- Range: -9.999MHz to +9.999MHz (in 1 kHz steps)

**SPLIT LOCK** (Default: OFF)

Turns the Split Lock function ON or OFF.

- OFF: Turn OFF the function.
- ON: Turn ON the function.

**Tuner (Auto Start)** (Default: OFF)

Turns the Automatic Tuning Start function ON or OFF.

(The automatic tuning function doesn't function on the 50 MHz band)

- OFF: Starts to tune only when [TUNER] is ON.
- ON: Automatically starts to tune when the SWR is higher than approximately 1.5, even if [TUNER] is OFF. (Only on the HF bands)

**Tuner (PTT Start)** (Default: OFF)

Turns the PTT Start Tuning function ON or OFF.

- OFF: Starts to tune only when [TUNER] is ON
- ON: When [TUNER] is ON and the operating frequency is shifted more than 1%, starts to tune when you push PTT.

**Tuner Preset Memory Clear**

Rotate [MAIN DIAL] to select the antenna, and then push [CLR](F) to clear the tuning preset.

- Options: ANT1, ANT2, ANT3, ANT4, ALL

☞ Select "ALL" to clear the ALL presets.

**Transverter Function** (Default: Auto)

Selects the transverter operating mode.

- ON: Turn ON the function.
- Auto: The transceiver switches to the transverter operating mode when 2 V to 13.8 V DC is applied to pin 6 of [A/B ACC2].

**Transverter Offset** (Default: 16.000MHz)

Sets the offset frequency for transverter operation.

- Range: 0.000 MHz-99.999 MHz (in 1 kHz steps)

**RTTY Mark Frequency** (Default: 2125)

Selects the RTTY mark frequency.

- Options: 1275, 1615, 2125 (Hz)

☞ When the internal RTTY decoder is used, 2125 Hz is automatically selected.

**RTTY Shift Width** (Default: 170)

Selects the RTTY shift width.

- Options: 170, 200, 425 (Hz)

☞ When the internal RTTY decoder is used, 170 Hz is automatically selected.

**RTTY Keying Polarity** (Default: Normal)

Selects the RTTY keying polarity.

- Normal: Key open/close = Mark/Space
- Reverse: Key open/close = Space/Mark

**PSK Tone Frequency** (Default: 1500)

Selects the PSK tone frequency for PSK reception.

- Options: 1000, 1500, 2000 (Hz)

**SPEECH Language** (Default: English)

Selects the speech language.

- English: English.
- Japanese: Japanese.

**SPEECH Speed** (Default: HIGH)

Selects the speech speed.

- LOW: Slow.
- HIGH: Fast.

**SPEECH S-Level** (Default: ON)

Turns the S-meter level announcement ON or OFF.

- OFF: The S-meter level is not announced.
- ON: The S-meter level and frequency is announced.

## ■ Others set screen (continued)

### **SPEECH [MODE] Switch** (Default: OFF)

Turns the operating mode announcement ON or OFF.

- OFF: The operating mode is announced.
- ON: The operating mode is announcer when the mode is changed.

### **Memo Pad Quantity** (Default: 5)

Sets the number of memo pad channels.

- 5: 5 channels.
- 10: 10 channels.

### **MAIN DIAL Operation** (Default: MAIN/SUB)

Selects [MAIN DIAL] operating mode.

- MAIN: The only Main band frequency can be set by rotating [MAIN DIAL].
- MAIN/SUB: The Sub band frequency can be also set by rotating [MAIN DIAL] when the Sub band is selected.

### **MAIN DIAL Auto TS** (Default: HIGH)

Sets the Automatic Tuning Step function for [MAIN DIAL].

When rapidly rotating [MAIN DIAL], the tuning step is automatically changed according to the rotation speed.

- OFF: Turn OFF the function.
- LOW: Tuning step is automatically changed in the low step.
- HIGH: Tuning step is automatically changed in the high step.

### **SUB DIAL Auto TS** (Default: HIGH)

Sets the Automatic Tuning Step function for [SUB DIAL].

When rapidly rotating [SUB DIAL], the tuning step is automatically changed according to the rotation speed.

- OFF: Turn OFF the function.
- LOW: Tuning step is automatically changed in the low step.
- HIGH: Tuning step is automatically changed in the high step.

### **MAIN/SUB Tracking [MAIN] SW** (Default: OFF)

Assigns the Main/Sub band tracking function to the [MAIN] key.

- OFF: The [MAIN] key does not act as the Tracking function key.
- ON: Hold down the [MAIN] key for 1 second to turn the function ON or OFF.
  - Hold down the [SUB] key for 1 second also turns the function OFF.
  - In the tracking mode, rotate [MAIN DIAL] changes the MAIN and SUB bands' frequencies. Rotate [SUB DIAL] to change only the SUB band frequency.

### **MIC Up/Down Speed** (Default: HIGH)

Sets the response speed of [UP]/[DN] on the optional microphone.

- LOW: Slow.
- HIGH: Fast.

### **Quick RIT/ $\Delta$ TX Clear** (Default: OFF)

Selects the operation of [CLEAR] for the RIT/ $\Delta$ TX function.

- OFF: Hold down [CLEAR] for 1 second to clear.
- ON: Push [CLEAR] to clear.

### **[NOTCH] Switch (SSB)** (Default: Auto/Manual)

Selects the notch function for the SSB mode.

- Auto: Auto notch.
- Manual: Manual notch.
- Auto/Manual: Auto notch and manual notch can be toggled.

### **[NOTCH] Switch (AM)** (Default: Auto/Manual)

Selects the notch function for the AM mode.

- Auto: Auto notch.
- Manual: Manual notch.
- Auto/Manual: Auto notch and manual notch can be toggled.

### **DIGI-SEL VR Operation** (Default: DIGI-SEL)

Selects the function assigned to [DIGI-SEL].

- DIGI-SEL: Used for the digital selector adjustment.
- APF: Used for the audio peak filter adjustment.

**■ Others set screen (continued)****FILTER Screen MAIN/SUB Select**

(Default: Auto (by FILTER,PBT Operation))

Selects the filter setting display.

- **Fix:** (always)  
The selected band's filter setting is always displayed.
- **AUTO** (By FILTER,PBT Operation): (relative)  
The displayed filter setting is automatically changed when [FILTER]/[PBT] is pushed/rotated.

**SSB/CW Synchronous Tuning** (Default: OFF)

Turns the Displayed Frequency Shift function ON or OFF.

This function automatically shifts the frequency to match the CW pitch when the operating mode is toggled between SSB and CW.

- **OFF:** Stays on the frequency even when the operating mode is changed between SSB and CW.
- **ON:** Shifts the frequency when the operating mode is toggled between SSB and CW, to keep receiving the signal.

**CW Normal Side** (Default: LSB)

Selects the carrier point in the CW normal mode.

- **LSB:** The LSB side.
- **USB:** The USB side.

**APF Type** (Default: SOFT)

Selects the audio filter type for APF.

- **SOFT:** Soft sound.  
The filter bandwidth is automatically changed according to the CW pitch, to make it easier to distinguish between noise and a signal.
- **SHARP:** Sharp sound.  
The filter bandwidth is fixed regardless of the CW pitch, to make it easier to reject interfering signals.

**MIC AF Out** (Default: MAIN+SUB)

Selects the band(s) audio to output from [MIC].

- **MAIN+SUB:** Outputs both Main and Sub bands audio.
- **SUB:** Outputs only Sub band audio.

**MIC Input DC Bias** (Default: ON)

Outputs the 8 V bias voltage (approximately) from the microphone connector (pin 1 of [MIC]).

- **OFF:** When using a microphone that doesn't need bias voltage (example: dynamic microphones).
- **ON:** When using an Icom's microphone or microphone that needs a bias voltage.

**External Keypad (VOICE) OFF** (Default: OFF)

Enables voice memory transmission using an external keypad.

- **OFF:** Turn OFF the function.
- **ON:** Pushing one of the external keypad switches, transmits the programmed voice memory (T1–T8). (SSB/AM/FM mode)  
Holding down the switch for 1 second to repeatedly transmit.

**External Keypad (KEYER)** (Default: OFF)

Enables keyer memory transmission using an external keypad.

- **OFF:** Turn OFF the function.
- **ON:** Pushing one of the external keypad switches, transmits the programmed keyer memory (M1–M8). (CW mode)  
Holding down the switch for 1 second to repeatedly transmit.

**External Keypad (RTTY)** (Default: OFF)

Enables the RTTY memory transmission using an external keypad.

- **OFF:** Turn OFF the function.
- **ON:** Pushing one of the external keypad switches, transmits the programmed RTTY memory (RT1–RT8). (When the RTTY decode screen is opened in the RTTY mode)

▨ When the external keypad is connected to [MIC], only RTTY memory channels RT1–RT4 can be transmitted using the external keypad.

**External Keypad (PSK)** (Default: OFF)

Enables the PSK memory transmission using an external keypad.

- **OFF:** Turn OFF the function.
- **ON:** Pushing one of the external keypad switches, transmits the programmed PSK memory (PT1–PT8). (When the PSK decode screen is opened in the PSK mode)

▨ When the external keypad is connected to [MIC], only PSK memory channels PT1–PT4 can be transmitted using the external keypad.

## ■ Others set screen (continued)

### **Keyboard [F1]–[F8] (VOICE)** (Default: OFF)

Enables the voice memory transmission using a keyboard connected to [USB A].

- OFF: Turn OFF the function.
- ON: Pushing one of [F1] to [F8] on the keyboard, transmits the programmed voice memory (T1–T8).  
Holding down [SHIFT] and pushing one of [F1] to [F8] on the keyboard repeatedly transmits memory.

### **Keyboard [F1]–[F8] (KEYER)** (Default: OFF)

Enables keyer memory transmission using a keyboard connected to [USB A].

- OFF: Turn OFF the function.
- ON: Pushing one of [F1] to [F8] on the keyboard, transmits the programmed keyer memory.  
Holding down [SHIFT] and pushing one of [F1] to [F8] on the keyboard repeatedly transmits memory.

### **Screen Capture [POWER] SW** (Default: OFF)

Assigns the Screen capture function to the [POWER] key.

- OFF: The [POWER] key does not act as the Screen capture key.
- ON: Push the [POWER] key to capture the screen. The captured screen is saved onto the selected storage media in the selected data format.

### **Screen Capture Keyboard [Print Screen]** (Default: OFF)

Assigns the Screen capture function to the [Print Screen] key on the USB keyboard.

- OFF: The [Print Screen] key does not act as the Screen capture key.
- ON: Push the [Print Screen] key to capture the screen. The captured screen is saved onto the selected storage media in the selected data format.

### **Screen Capture Storage Media** (Default: SD CARD)

Select the storage media for the Screen capture function.

- Options: SD CARD or USB flash drive.

### **Screen Capture Data Format** (Default: PNG)

Select the data format for the Screen capture function.

- Options: PNG or BMP

When the Screen capture function is assigned to either the [POWER] key or [Print Screen] on the USB keyboard:

- ① Set a desired screen.
  - ② Push [POWER] or [Print screen] to capture the screen.
    - The captured screen is saved onto the selected storage media in the selected data format.
- You can display the captured screen on the transceiver display. See page 10-10 for details.

### **Shutdown Function** (Default: Shutdown)

Selects the shutdown option.

- Shutdown: Shuts down right after [POWER] has been held down for 1 second.
- Standby/Shutdown: Enters the remote standby mode.  
If the remote standby mode is selected, the transceiver can be remotely turned ON later using the optional RS-BA1.

#### ○ When "Standby/Shutdown" is selected

- ① Hold down [POWER] for approximately for 1 second to turn OFF the power.
  - The shutdown option dialogue appears.
- ② Select the shutdown option using [▲](F) or [▼](F).
  - If you want to turn OFF the power immediately, select "Shutdown."
  - If you want to remotely turn ON the power later, select "Standby (for Remote Control)."  
\*The power indicator, which is located on the right above [POWER], slowly blinks Orange.  
The cooling fan still rotates.
- ③ Push [POWER].

### **CI-V Baud Rate** (Default: Auto)

Selects the CI-V data transfer rate.

- Options: 4800, 9600, 19200 (bps) and Auto

When "Auto" is selected, the baud rate is automatically set, according to the data rate of the connected controller.



■ Others set screen (continued)

## CI-V Address (Default: 8Eh)

Selects the CI-V address.

- Range: 02h–8Eh–DFh
- /// "8Eh" is the default address of IC-7850/IC-7851.

## CI-V Transceive (Default: ON)

Turns the Transceive function ON or OFF.

- OFF: Turn the function OFF.
- ON: Turn the function ON.

## CI-V USB/LAN➔REMOTE Transceive Address (Default: 00h)

Sets the address used to remotely control the transceiver/receiver, through [USB B] or [LAN]. The control signal is output from [REMOTE].

- Range: 00h–DFh

When multiple equipment are connected:  
The default transceive address is "00h."  
To control dedicated equipment (example IC-PW1) when several equipment are connected, match the same CI-V address.

## CI-V Output (for ANT) (Default: OFF)

Enables to output the antenna controller status (frequency and so on) from [REMOTE].

- OFF: Turns OFF the function.
- ON: Outputs the status.

/// Address "01h" is reserved. The usable addresses are limited to 02h–DFh.

## CI-V USB Port (Default: Link to [REMOTE])

Selects the internal connection type of [USB B] and [REMOTE].

- Link to [REMOTE]:  
The CI-V port of the USB port and [REMOTE] are internally connected.
- Unlink from [REMOTE]:  
The CI-V port of USB port and [REMOTE] are not internally connected. Each port functions independently. (duplex communication can be made.)

## CI-V USB Baud Rate (Default: Auto)

Selects the CI-V data transfer rate when remotely controlling the transceiver, through the CI-V port of the [USB B] port.

- Options: 4800, 9600, 19200, 38400, 57600, 115200 (bps), Auto

/// When "Auto" is selected, the baud rate is automatically set according to the data rate of connected controller.

/// This setting is valid only when "REMOTE" is selected in the [CI-V USB Port] item.

## CI-V USB Echo Back (Default: OFF)

Turns the Data Echo Back function ON or OFF, when remotely controlling the transceiver through the CI-V port of the [USB B] port.

- OFF: Turn OFF the function.
- ON: Turn ON the function.

/// This setting is valid when "REMOTE" is selected in the [CI-V USB Port] item.

## Decode Baud Rate (Default: 9600)

Selects the data transfer rate (Baud rate) of decoded RTTY/PSK signal.

- Options: 4800, 9600, 19200, 38400 (bps)

## USB SEND (Default: OFF)

You can control transmit and receive from the PC through the USB port.

Select the control port to be used for communication between the transceiver and PC, according to the operating condition.

- OFF: Turn OFF the function.
- USB1 DTR: Use the DTR terminal on the CI-V (PC) side.
- USB1 RTS: Use the RTS terminal on the CI-V (PC) side.
- USB2 DTR: Use the DTR terminal on the DECODE (transceiver) side.
- USB2 RTS: Use the RTS terminal on the DECODE (transceiver) side.

/// You cannot select the terminal which is already selected in the [USB Keying (CW)] item or [USB Keying (RTTY)].



## ■ Others set screen (continued)

### **USB Keying (CW)** (Default: OFF)

You can control to transmit, receive and keying from the PC, through the USB port.

Select the control port to be used for communication between the transceiver and PC, according to the operating condition.

- OFF: Turn OFF the function.
- USB1 DTR: Use the DTR terminal on the CI-V (PC) side.
- USB1 RTS: Use the RTS terminal on the CI-V (PC) side.
- USB2 DTR: Use the DTR terminal on the DECODE (transceiver) side.
- USB2 RTS: Use the RTS terminal on the DECODE (transceiver) side.

/// You cannot select the terminal which is already selected in the [USB SEND] item.

### **USB Keying (RTTY)** (Default: OFF)

You can control to transmit, receive and RTTY (FSK) from the PC, through the USB port.

Select the control port to be used for communication between the transceiver and PC, according to the operating condition.

- OFF: Turn OFF the function.
- USB1 DTR: Use the DTR terminal on the CI-V side.
- USB1 RTS: Use the RTS terminal on the CI-V side.
- USB2 DTR: Use the DTR terminal on the DECODE side.
- USB2 RTS: Use the RTS terminal on the DECODE side.

/// You cannot select the terminal which is already selected in the [USB SEND] item.

### **USB SEND/Keying Inhibit at connection**

(Default: OFF)

Turn ON the timer to prevent unintentional SEND or Keying signal transmission if the USB driver version is not the latest one, under the following conditions.

- When connecting a PC to the transceiver using a USB cable.
- When a virtual serial port communication has been established.
- While the transceiver and a PC are connected using a USB cable, or when starting up the PC or connecting or disconnecting a USB device to or from the PC.
- OFF: The transceiver transmits the SEND or Keying signal right after a PC or USB device is connected.
- ON: The transceiver transmits after a few seconds have passed, to prevent unintentional transmission.

/// If you change this setting to "OFF," update the transceiver's USB driver and make sure the SEND or Keying signal will not be unintentionally transmitted.

### **Keyboard Type** (Default: Japanese)

Selects the connected keyboard type.

- Options: English, Japanese, United Kingdom, French, French(Canadian), German, Portuguese, Portuguese (Brazilian), Spanish, Spanish (Latin American), Italian

### **Keyboard Repeat Delay** (Default: 250ms)

Sets the repeat delay time of the keyboard.

- Options: 100 ms–1000 ms (in 50 ms steps)

### **Keyboard Repeat Rate** (Default: 10.9cps)

Sets the repeat rate of the keyboard.

- Range: 2.0cps–30.0cps

## ■ Others set screen (continued)

### **Mouse Pointer Speed** (Default: MID)

Selects the mouse pointer speed.

- Options: SLOW, MID, FAST

### **Mouse Pointer Acceleration** (Default: ON)

Turns the mouse pointer acceleration ON or OFF.

- OFF: Turn OFF the function.
- ON: Turn ON the function.

### **USB DIAL Select** (Default: SUB Only)

Selects the Sub band or Main and Sub band to operate on the RC-28's main dial.

### **USB DIAL Auto TS** (Default: High)

Selects the Automatic Tuning Step for the RC-28's main dial.

When rapidly rotating the RC-28's main dial, the tuning step is automatically changed according to the rotation speed.

### **USB DIAL [TRANSMIT] Switch** (Default: Push to toggle)

Selects whether to toggle between transmit and receive by pushing, or to transmit only while holding the [TRANSMIT] key on the RC-28.

### **DHCP (Valid after Reboot)** (Default: ON)

Turns the DHCP function ON or OFF.

- OFF: Uses the static IP address.
- ON: Uses the DHCP function.
  - /// If a DHCP server is in your network environment, the IP address is automatically obtained.

/// This setting takes effect after reboot.

### **IP Address (Valid after Reboot)** (Default: 192.168. 0. 10)

Sets the static IP address.

- /// Push [◀ ▶](F) to select the item, and then turn [MAIN DIAL] to set the address.
- /// This setting is valid when "OFF" is selected the [DHCP (Valid after Reboot)] item.
- /// This setting takes effect after reboot.

### **Subnet Mask (Valid after Reboot)** (Default: 255.255.255.0 (24bit))

Sets the subnet mask to connect to your PC or LAN (Local Area Network), through the Ethernet.

- /// Push [◀ ▶](F) to select the item, and then turn [MAIN DIAL] to set the address.
- /// This setting is valid when "OFF" is selected the [DHCP (Valid after Reboot)] item.
- /// This setting takes effect after reboot.

### **Default Gateway (Valid after Reboot)** (Default: . . . )

When you remotely control the transceiver using the optional RS-BA1, a default gateway setting is required.

- /// Push [◀ ▶](F) to select the item, and then turn [MAIN DIAL] to set the address.
- /// This setting is valid when "OFF" is selected in the [DHCP (Valid after Reboot)] item.
- /// This setting takes effect after reboot.

### **Primary DNS Server (Valid after Reboot)** (Default: . . . )

If there are two DNS server addresses, enter the primary DNS server address.

- /// Push [◀ ▶](F) to select the item, and then turn [MAIN DIAL] to set the address.
- /// This setting is valid when "OFF" is selected the [DHCP (Valid after Reboot)] item.
- /// This setting takes effect after reboot.

### **2nd DNS Server (Valid after Reboot)** (Default: . . . )

If there are two DNS server addresses, enter the secondary DNS server address.

- /// Push [◀ ▶](F) to select the item, and then turn [MAIN DIAL] to set the address.
- /// This setting is valid when "OFF" is selected the [DHCP (Valid after Reboot)] item.
- /// This setting takes effect after reboot.

## ■ Others set screen (continued)

### Network Name

When you remotely control the transceiver using the optional RS-BA1, enter a network name of up to 15 characters.

Usable characters:

Characters (a–z, A–Z, 0–9) and symbols (! # \$ %& " ` ^ + - . , ; = ( ) [ ] { } \_ ~ @)

- Push [EDIT](F) to enter the edit mode.
- Push [ABC] or [abc] to toggle the character type between upper case and lower case letters.
- Push [123] or [Symbol] to toggle the character type between numbers and symbols.
- Rotate [MAIN DIAL] to select a character.
- Push [◀](F) to move the cursor to the left, push [▶](F) to move the cursor right.
- Push [DEL](F) to delete the selected character.
- Push [EXIT/SET] to cancel and exit the edit mode.
- Push [SET](F) to save.

### Network Control (Valid after Reboot)

(Default: OFF)

When you remotely control the transceiver using the optional RS-BA1, select "ON."

- OFF: Turn OFF the function.
- ON: Turn ON the function.

### Control Port (UDP) (Valid after Reboot)

(Default: 50001)

When you remotely control the transceiver using the optional RS-BA1 software, set a port number for the control signal transfers between the transceiver and the remote station.

- Set the same port number to the remote station.
- This setting takes effect after reboot.

### Serial Port (UDP) (Valid after Reboot)

(Default: 50002)

When you remotely control the transceiver using the optional RS-BA1 software, set a port number for the serial data transfers between the transceiver and the remote station.

- Set the same port number to the remote station.
- This setting takes effect after reboot.

### Audio Port (UDP) (Valid after Reboot)

(Default: 50003)

When you remotely control the transceiver using the optional RS-BA1 software, set a port number for the audio signal transfers between the transceiver and the remote station.

- Set the same port number to the remote station.
- This setting takes effect after reboot.

### Internet Access Line (Valid after Reboot)

(Default: FTTH)

When you remotely control the transceiver using the optional RS-BA1 software, set the internet access line setting between the transceiver and the remote station.

- Select FTTH (Fiber To The Home) or ADSL/CATV.
- This setting takes effect after reboot.

### Network User1/2/3 ID

When you remotely control the transceiver using the optional RS-BA1, enter a user name of up to 16 characters.

Usable characters:

Characters (a–z, A–Z, 0–9) and symbols (! # \$ %& ? " ' ` ^ + - \* / . , ; = < > ( ) [ ] { } | \_ ~ @)

- Push [EDIT](F) to enter the edit mode.
- Push [ABC] or [abc] to toggle the character type between upper case and lower case letters.
- Push [123] or [Symbol] to toggle the character type between numbers and symbols.
- Rotate [MAIN DIAL] to select a character.
- Push [◀](F) to move the cursor to the left, push [▶](F) to move the cursor right.
- Push [DEL](F) to delete the selected character.
- Push [EXIT/SET] to cancel and exit the edit mode.
- Push [SET](F) to save.

**■ Others set screen (continued)****Network User1/2/3 Password**

---

Enter a password for each user.

Usable characters:

Characters (a–z, A–Z, 0–9) and symbols (! # \$ %& ? " ' ` ^ + - \* / . , ; = < > ( ) [ ] { } | \_ ~ @)

- Push [EDIT](F) to enter the edit mode.
- Push [ABC] or [abc] to toggle the character type between upper case and lower case letters.
- Push [123] or [Symbol] to toggle the character type between numbers and symbols.
- Rotate [MAIN DIAL] to select a character.
- Push [◀](F) to move the cursor to the left, push [▶](F) to move the cursor right.
- Push [DEL](F) to delete the selected character.
- Push [EXIT/SET] to cancel and exit the edit mode.
- Push [SET](F) to save.

The entered password is masked by "\*."

**Network User1/2/3 Administrator**

(Default: NO)

Sets the user as the administrator.

Only the authorized user can disconnect the communication between the transceiver and the remote station.

- NO: Not authorized.
- YES: Authorized.

**Network Radio Name**

(Default for IC-7850: IC-7850)

(Default for IC-7851: IC-7851)

When you remotely control the transceiver using the optional RS-BA1 software, enter a name of up to 15 characters.

Usable characters:

Characters (a–z, A–Z, 0–9) and symbols (! # \$ %& ? " ' ` ^ + - \* / . , ; = < > ( ) [ ] { } | \_ ~ @)

- Push [EDIT](F) to enter the edit mode.
- Push [ABC] or [abc] to toggle the character type between upper case and lower case letters.
- Push [123] or [Symbol] to toggle the character type between numbers and symbols.
- Rotate [MAIN DIAL] to select a character.
- Push [◀](F) to move the cursor to the left, push [▶](F) to move the cursor right.
- Push [DEL](F) to delete the selected character.
- Push [EXIT/SET] to cancel and exit the edit mode.
- Push [SET](F) to save.

■ Adjusting the Main dial brake .....	16-2
■ Using the Voice synthesizer operation .....	16-2
■ SWR reading .....	16-3
■ Calibration the Frequency (approximate) .....	16-4
■ Setting My call sign .....	16-5
■ Cleaning .....	16-7
■ Resetting the CPU .....	16-7
◇ Resetting .....	16-7
■ About protection indications .....	16-8
■ Opening the transceiver's case .....	16-8
■ Fuse replacement .....	16-9
■ Clock backup battery replacement .....	16-9
■ Troubleshooting .....	16-10
◇ Transceiver power .....	16-10
◇ Transmit and receive .....	16-10
◇ Scanning .....	16-11
◇ Display .....	16-11

## ■ Adjusting the Main dial brake

The tension of [MAIN DIAL] may be adjusted to suit your preference.

The brake adjustment is located on the bottom side of the front panel. See the figure to the right.

Slide the brake adjustment for a comfortable tension level while turning the dial continuously and evenly in one direction.

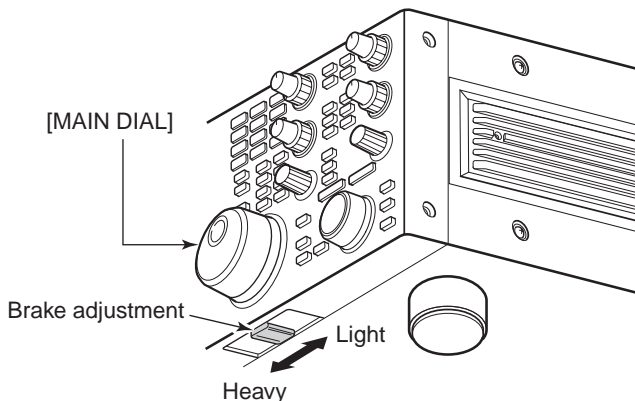

## ■ Using the Voice synthesizer operation

The transceiver has built-in Voice synthesizer to announce the operating frequency, mode, as well as the S-meter level in clear electronically-generated voice in English (or Japanese).

The announcement can be independently made for both the Main and Sub bands.

First, set the announcement language, speed, and mode in the Others set mode (p. 15-14).

- Push [SPEECH] to announce the currently selected frequency (or frequency and S-meter level).
  - Hold down [SPEECH] for 1 second to additionally announce the selected operating mode.
- Pushing a Mode key also announces the appropriate mode. (p. 15-15)

/// The output level of the voice synthesizer can be adjusted in Level set mode. (p. 15-5)  
 /// (SET [F-7] > LEVEL [F-1] > Speech Level)

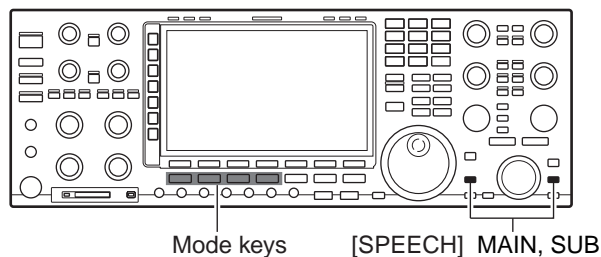



## ■ SWR reading

The transceiver has a high-performance SWR meter. The meter displays a stable measurement in real time, even if the transmit output power varies frequently, such as during SSB mode operation. You can measure the SWR of an antenna itself, through the internal antenna tuner.

- ① Push [TUNER] to turn the antenna tuner OFF.
- ② Hold down the Multi-function [METER](▶) key for 1 second to display the Multi-function meter.
- ③ Push the Mode key [RTTY/PSK] once or twice to select the RTTY mode.
- ④ Push [TRANSMIT].
- ⑤ Rotate [RF PWR] clockwise past the 9 o'clock position for more than 30 W of output power.
- ⑥ Read the SWR on the SWR meter gage.
- ⑦ Push [EXIT/SET] to close multi-function meter.

### • SWR Meter

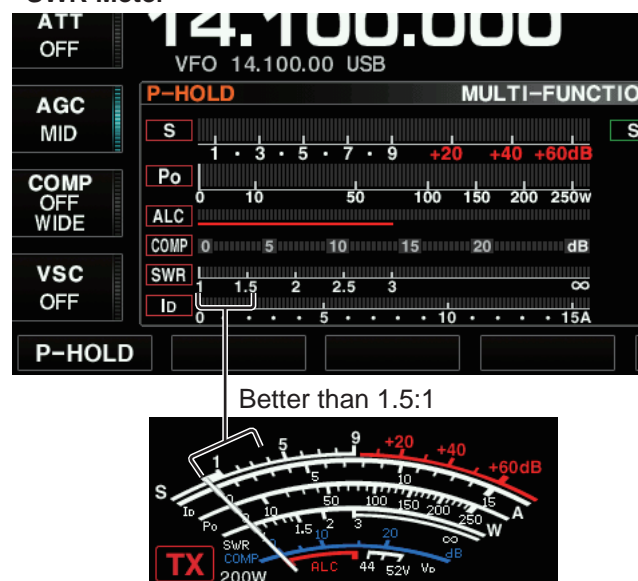

## ■ Screen type and font selections

3 types of screen images and 9 types of frequency readout fonts are selectable.

- ① Select the "Display Type" or "Display Font" item in the Display set screen.
  - SET [F-7] ↘ DISPLAY [F-3] ↘ Display Type**
  - SET [F-7] ↘ DISPLAY [F-3] ↘ Display Font**
- ② Rotate [MAIN DIAL] to select the desired screen image or font.
  - Hold down [DEF](F) for 1 second to return the default setting.
- ③ Push [EXIT/SET] twice.
  - Exits the Set screen.

### • Screen image example— type B



## ■ Calibration the Frequency (approximate)

A very accurate frequency counter is required to calibrate the frequency of the transceiver. However, a rough check may be performed by receiving radio station WWV, WWVH, or other standard frequency signals.

**CAUTION:** The transceiver has been thoroughly adjusted and tested at the factory before being shipped. You should not have to re-calibrate it.

- ① Push the Mode key [SSB] to select USB mode.
- ② Hold down [PBT CLEAR] for 1 second to clear the PBT setting and make sure that the RIT/ $\Delta$ TX function is not activated.
- ③ Set the frequency to the standard frequency station minus 1 kHz.
  - When receiving WWV or WWVH (at 15.00000 MHz) as a standard frequency, set the operating frequency for 14.99900 MHz.
  - Other standard frequencies can be used.
- ④ Push [EXIT/SET] several times to close a Multi-function screen, if necessary.
- ⑤ Select the “Calibration Marker” item in the Display set screen.

**SET [F-7]  $\triangleright$  OTHERS [F-5]  $\triangleright$  Calibration Marker**

- ⑥ Rotate [MAIN DIAL] clockwise to turn the calibration marker ON.
- ⑦ Push [EXIT/SET] once to return to the Set mode menu screen.
- ⑧ Select the “REF Adjust” item in the ACC set screen.

**SET [F-7]  $\triangleright$  ACC [F-2]  $\triangleright$  REF Adjust**

- ⑨ Rotate [MAIN DIAL] to adjust for a zero beat with the received standard signal as shown at left.
  - Zero beat means that two signals are exactly the same frequency, resulting in a single tone being emitted.
- ⑩ Turn the calibration marker OFF in the Others set mode.
- ⑪ Push [EXIT/SET] twice.
  - Exits the Set screen.

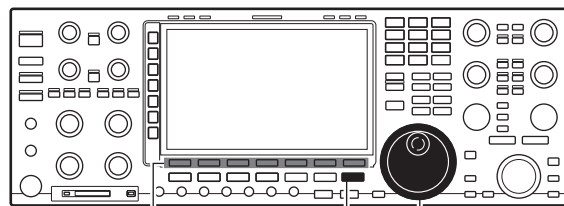

(F) Function keys [EXIT/SET] [MAIN DIAL]

### • Calibration Marker item



### • REF Adjust item

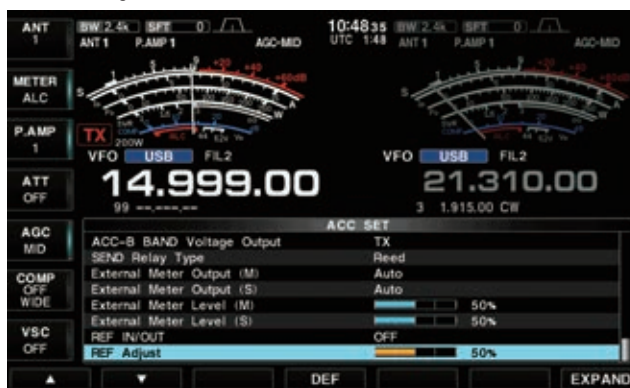

## ■ Setting My call sign

Your own call sign can be displayed at power ON.

**[Example] Set the call sign JA3YUA.**

① Select the "My Call" item in the Display set screen.

**SET [F-7] ▾ DISPLAY [F-3] ▾ My Call**

② Push [EDIT](F).

- A cursor blinks.

③ Push [ABC](▶) or [123](▶).

- Pushing [123](▶) again to toggle between numbers and symbols.

④ Rotate [MAIN DIAL] to select "J."

⑤ Push [◀](F) or [▶](F) to select a desired digit.

⑥ Repeat the steps ③ to ⑤ to enter the call sign.

- Push [SPACE](F) to enter a space.
  - Push [DEL](F) to delete the selected character.
  - Holding down [DEL](F) to delete the characters to the right of the cursor.
  - Pushing 10-key, [0]~[9], can also enter numbers.
  - See the table below to the right for usable characters.
- The call sign can be entered from an external keyboard.

⑦ Push [EXIT/SET].

- The call sign is saved.

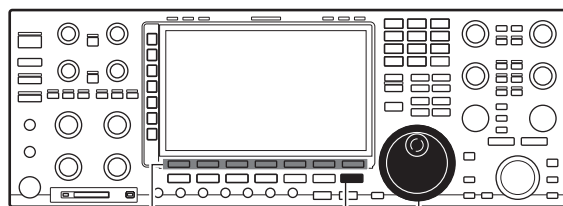

(F) Function keys [EXIT/SET] [MAIN DIAL]

### • My Call setting screen



<b>ABC</b>	A B C D E F G H I J K L M N O P Q R S T U V W X Y Z
<b>123</b>	1 2 3 4 5 6 7 8 9 0
<b>Symbol</b>	- / . @

## ■ Screen saver function

The transceiver has a screen saver function to protect the LCD from the “burn-in” effect.

The screen saver functions when no operation is performed for the set time period.

- ① Select the “Screen Saver Function” item in the Display set screen.

**SET [F-7] ▸ DISPLAY [F-3] ▸ Screen Saver Function**

- ② Rotate [MAIN DIAL] to select a desired option.
  - Selectable options: OFF (deactivate the function), 15min., 30min., 60min. (default: 60min.)
- ③ Push [▼](F) to select the “Screen Saver Type” item.
- ④ Rotate [MAIN DIAL] to select a desired screen saver type.
  - Selectable type: Bounce, Rotation, Twist, Sleep (default: Bounce)
  - The selected screen saver is displayed while holding down [PREVIEW](F).
  - While the screen saver is activated, the [MAIN] or [SUB] key indicator blinks, whichever one was selected at the time.
- ⑤ Push [EXIT/SET] twice.
  - Exits the Set screen.

**NOTE:** When the screen saver function is activated, the LCD backlight brightness level is set to minimum.

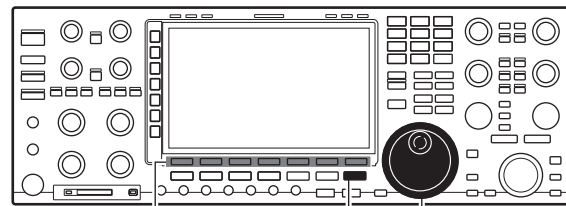

(F) Function keys [EXIT/SET] [MAIN DIAL]

### • Screen Saver Type: Twist



## ■ Cleaning



If the transceiver becomes dusty or dirty, wipe it clean with a dry, soft cloth.



**DO NOT** use harsh solvents such as benzine or alcohol when cleaning, as they will damage the transceiver surfaces.

## ■ Resetting the CPU

**NOTE:** Resetting **CLEARs** all programmed contents in memory channels and returns programmed values in the Set mode to default values.

**Recommendation:** Save memory channel content, setting status, and so on, onto an SD card or a USB flash drive before resetting the CPU.

**NOTE:** If "Standby/Shutdown" is selected in "Shutdown Function" item in the OTHERS Set menu (p. 15-17), the CPU cannot be reset. In that case, hold down [POWER] for 1 second, then select "Shutdown" to turn OFF the transceiver. After that, reset the CPU as shown below.

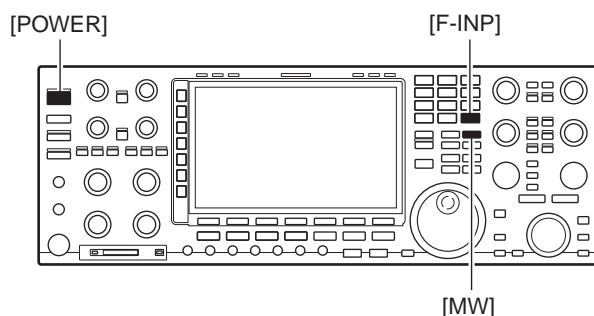

### ◇ Resetting

- ① Turn ON the main power switch on the rear panel.
  - Make sure the transceiver power is still OFF.
- ② While holding down [F-INP] and [MW], push [POWER] to turn ON power.
  - The internal CPU is reset.
  - The CPU start-up takes approximately 5 seconds.
  - "ALL CLEAR" is displayed when the reset is successful.
  - The transceiver displays its initial VFO frequencies after resetting.

## About protection indications

The transceiver has a 2 step protection function to protect the final power amplifiers.

The function detects the power amplifier temperature and activates when the temperature becomes extremely high.

- **Power down transmission**

Reduces the transmit output power to 100 W. "LMT" appears beside the transmit indicator during transmit.

- **Transmission inhibit**

Disables the transmitter. The transmit indicator is displayed in gray during transmit.

When the function is activated, wait until the power amplifier cools down using the transceiver in the standby or receive mode.

**NOTE: DO NOT** turn the transceiver power OFF. The internal cooling fan does not function, so it will take longer to cool the transceiver.

The power amplifier temperature can be monitored in the multi-function meter, TEMP gauge.



Check the temperature

## Opening the transceiver's case

Follow the case opening procedures shown here when you want to replace the clock backup battery or internal fuse.

**WARNING!** DISCONNECT the AC power cable from the transceiver before performing any work on the transceiver. Otherwise, there is danger of electric shock and/or equipment damage.

**CAUTION:** The transceiver weighs approximately 23.5 kg (52 lb). Always have two people available to lift or invert over the transceiver.

- 1 Remove the 8 screws from the top of the transceiver and the 6 screws from the sides, then lift up the top cover.
- 2 Turn the transceiver upside-down.

**CAUTION: NEVER HOLD THE MAIN DIAL OR ANY OTHER KNOBS** when the transceiver is upside down. This may damage the transceiver.

- 3 Remove 6 screws from the bottom, and the 6 screws from the sides, then lift up the bottom cover.

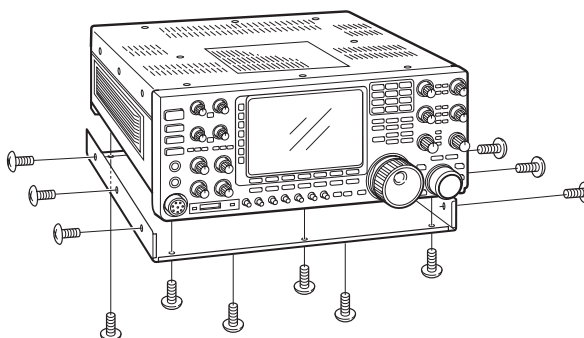
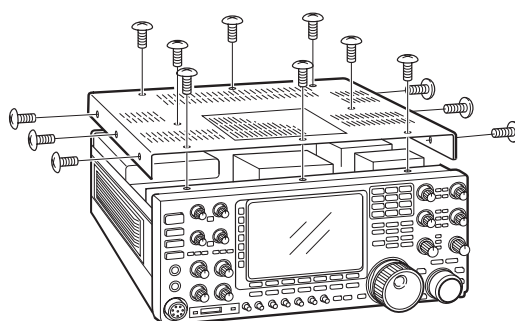



## ■ Fuse replacement

When no external DC output is available from [EXT DC] and ACC connectors, the internal fuse may be open. Replace the fuse in this case.

**⚠ WARNING! DISCONNECT** the AC power cable from the AC outlet before removing the transceiver's cover.

**CAUTION:** The transceiver weighs approximately 23.5 kg (52 lb). Always have two people available to lift or invert over the transceiver.

- ① Remove the bottom cover.
- ② Replace the open fuse with a new, properly rated one (TYPE 1202 FUSE 2 A) as shown at right.
- ③ Replace the bottom cover.

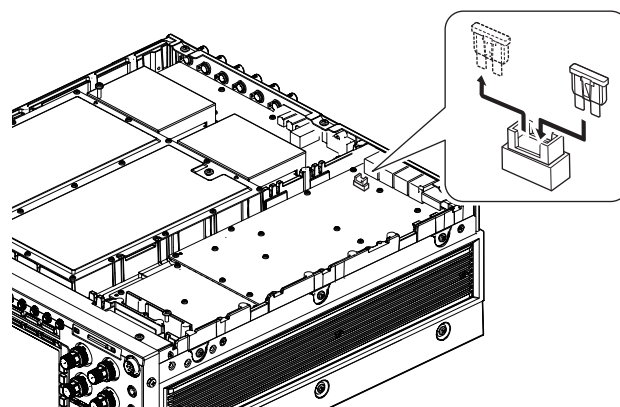

## ■ Clock backup battery replacement

The transceiver has a lithium backup battery (CR2032) inside for clock and timer functions.

When the backup battery exhausted, the transceiver transmits and receives normally but cannot retain the current time.

**⚠ WARNING! DISCONNECT** the AC power cable from the AC outlet before removing the transceiver's cover.

- ① Remove the top cover.
- ② Replace the clock backup battery, located near the front panel as illustrated at left.
  - Make sure the battery polarity is correct.
- ③ Return the top cover to the original position.
- ④ Set the date and time in Time set screen. (p. 14-2)

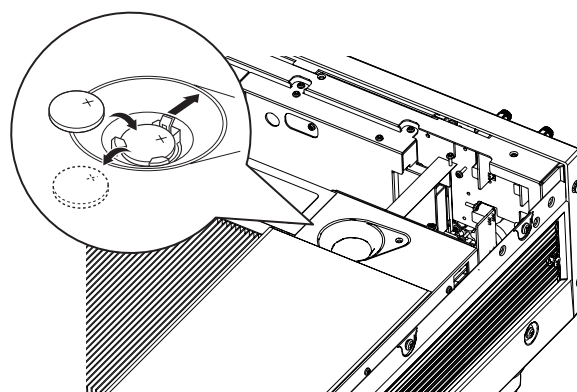

### For Users in California (U.S.A.)

This CR2032 Lithium Battery contains Perchlorate Material—special handling may apply.

See <http://www.dtsc.ca.gov/hazardouswaste/perchlorate>

## ■ Troubleshooting

The following chart is designed to help you correct problems which are not equipment malfunctions. If you are unable to locate the cause of a problem or solve it through the use of this chart, contact your nearest Icom Dealer or Service Center.

### ◇ Transceiver power

PROBLEM	POSSIBLE CAUSE	SOLUTION	REF.
Power does not come on when the [POWER] key is pushed.	<ul style="list-style-type: none"> <li>• Power cable is improperly connected.</li> <li>• The internal power supply is turned OFF.</li> <li>• Circuit breaker is tripped.</li> </ul>	<ul style="list-style-type: none"> <li>• Re-connect the AC power cable correctly.</li> <li>• Turn the internal power supply ON.</li> <li>• Check for the cause, then re-set the circuit breaker.</li> </ul>	<p>p. 3-4 p. 3-4 p. 1-12</p>

### ◇ Transmit and receive

PROBLEM	POSSIBLE CAUSE	SOLUTION	REF.
No sound is heard from the speaker.	<ul style="list-style-type: none"> <li>• Volume level is too low.</li> <li>• The squelch is closed.</li> <li>• The transceiver is transmitting.</li> </ul>	<ul style="list-style-type: none"> <li>• Rotate [AF] clockwise to obtain a suitable listening level.</li> <li>• Turn [SQL] to 10 o'clock position to open the squelch.</li> <li>• Push [TRANSMIT] to receive or check the SEND line of an external unit, if connected.</li> </ul>	<p>p. 4-4 p. 4-4 p. 4-13</p>
Sensitivity is too low, and only strong signals are audible.	<ul style="list-style-type: none"> <li>• The antenna is not properly connected.</li> <li>• An antenna for another band is selected.</li> <li>• The antenna is not properly tuned.</li> <li>• The attenuator is activated.</li> </ul>	<ul style="list-style-type: none"> <li>• Reconnect to the antenna connector.</li> <li>• Select an antenna suitable for the operating frequency.</li> <li>• Hold down [TUNER] for 1 second to manually tune the antenna.</li> <li>• Push [ATT] several times to select "ATT OFF."</li> </ul>	<p>— p. 13-2 p. 13-7 p. 7-2</p>
Received audio is unclear or distorted.	<ul style="list-style-type: none"> <li>• The operating mode is selected.</li> <li>• The PBT function is activated.</li> <li>• The Noise blanker is turned ON when receiving a strong signal.</li> <li>• A preamp is activated.</li> <li>• The noise reduction is activated and the [NR] control is set too far clockwise.</li> </ul>	<ul style="list-style-type: none"> <li>• Select a suitable operating mode.</li> <li>• Hold down [PBT CLR] for 1 second to reset the function.</li> <li>• Push [NB] to turn the noise blanker OFF.</li> <li>• Push [P.AMP] once or twice to turn the function OFF.</li> <li>• Set the [NR] control for maximum readability.</li> </ul>	<p>p. 4-10 p. 7-5 p. 7-11 p. 7-2 p. 7-12</p>
The [ANT] key does not function.	<ul style="list-style-type: none"> <li>• The antenna key has not been activated.</li> </ul>	<ul style="list-style-type: none"> <li>• Set the antenna selection mode.</li> </ul>	<p>p. 13-5</p>
Transmitting is impossible.	<ul style="list-style-type: none"> <li>• The operating frequency is not inside a ham band.</li> </ul>	<ul style="list-style-type: none"> <li>• Set the frequency to a ham band.</li> </ul>	<p>p. 4-6</p>
Output power is too low.	<ul style="list-style-type: none"> <li>• [RF PWR] is set too far counterclockwise</li> <li>• [DRIVE] is set too far counterclockwise</li> <li>• [MIC] is set too far counterclockwise</li> <li>• An antenna for another band is selected.</li> <li>• The antenna is not properly tuned.</li> </ul>	<ul style="list-style-type: none"> <li>• Rotate [RF PWR] clockwise.</li> <li>• Set [DRIVE] to a suitable position.</li> <li>• Set [MIC] to a suitable position.</li> <li>• Select an antenna suitable for the operating frequency.</li> <li>• Hold down [TUNER] for 1 second to manually tune the antenna.</li> </ul>	<p>p. 4-4 p. 4-14 p. 4-13 p. 13-2 p. 13-7</p>
No contact possible with another station.	<ul style="list-style-type: none"> <li>• RIT or ΔTX function is activated.</li> <li>• The Split frequency function and/or Dualwatch are activated.</li> </ul>	<ul style="list-style-type: none"> <li>• Push [RIT] or [ΔTX] to turn the function OFF.</li> <li>• Push [SPLIT] and/or [DUALWATCH] to turn the function OFF.</li> </ul>	<p>pp. 7-3, 8-5 pp. 7-10, 8-7</p>
Transmit signal is unclear or distorted.	<ul style="list-style-type: none"> <li>• [MIC] is set too far clockwise</li> </ul>	<ul style="list-style-type: none"> <li>• Set [MIC] to a suitable position.</li> </ul>	<p>p. 4-13</p>
Repeater cannot be accessed.	<ul style="list-style-type: none"> <li>• The Split frequency function is not activated.</li> <li>• The selected subaudible tone frequency is incorrect.</li> </ul>	<ul style="list-style-type: none"> <li>• Push [SPLIT] to turn the function ON</li> <li>• Reset the frequency in the Set mode.</li> </ul>	<p>p. 8-7 p. 5-38</p>

■ Troubleshooting (Continued)

◇ Scanning

PROBLEM	POSSIBLE CAUSE	SOLUTION	REF.
Programmed scan does not stop.	<ul style="list-style-type: none"> <li>Squelch is open.</li> </ul>	<ul style="list-style-type: none"> <li>Set [SQL] to the threshold point.</li> </ul>	p. 4-4
Programmed scan does not start.	<ul style="list-style-type: none"> <li>The same frequencies have been programmed in scan edge memory channels P1 and P2.</li> </ul>	<ul style="list-style-type: none"> <li>Program different frequencies in scan edge memory channels P1 and P2.</li> </ul>	p. 12-5
Memory scan does not start	<ul style="list-style-type: none"> <li>2 or more memory channels have not been programmed.</li> </ul>	<ul style="list-style-type: none"> <li>Program more than 2 memory channels.</li> </ul>	p. 12-5
Select memory scan does not start	<ul style="list-style-type: none"> <li>2 or more memory channels have not been designated as Select channels.</li> </ul>	<ul style="list-style-type: none"> <li>Designate more than 2 memory channels as Select channels for the scan.</li> </ul>	p. 12-7

◇ Display

PROBLEM	POSSIBLE CAUSE	SOLUTION	REF.
The displayed frequency does not properly change.	<ul style="list-style-type: none"> <li>The dial lock function is activated.</li> </ul>	<ul style="list-style-type: none"> <li>Push [LOCK] to turn the function OFF.</li> </ul>	p. 4-12
	<ul style="list-style-type: none"> <li>A Set mode screen is selected.</li> </ul>	<ul style="list-style-type: none"> <li>Push [EXIT/SET] several times to exit the Set mode screen.</li> </ul>	p. 15-2
	<ul style="list-style-type: none"> <li>The internal CPU has malfunctioned.</li> </ul>	<ul style="list-style-type: none"> <li>Reset the CPU.</li> </ul>	p. 16-7

- General ..... 17-2
  - ◇ Checking the firmware version ..... 17-2
- Preparation ..... 17-3
  - ◇ File downloading ..... 17-3
- Firmware update— using an SD card/USB flash drive ..... 17-4

### ■ General

The IC-7850/IC-7851's firmware can be updated, if desired. By updating the firmware, new function(s) can be added and the improvement of performance parameters can be made.

Ask your dealer or distributor about how to update the firmware if you have no PC.

### ◇ Checking the firmware version

While holding down [POWER], turn ON the power to display the Opening screen. On the right bottom of the screen, the firmware version is displayed.



The firmware version.

## ■ Preparation

### ◇ File downloading

- ① Access the following URL.  
<http://www.icom.co.jp/world/index.html>
- ② Click the [Support] button.
- ③ Click the “Firmware Updates/Software Downloads” link.
- ④ Click the desired firmware file link in the IC-7850/IC-7851 group.
- ⑤ Read “Regarding this Download Service” carefully, and then click [Agree].



Click

- ⑥ Click [Save as] in the displayed File Download dialog.

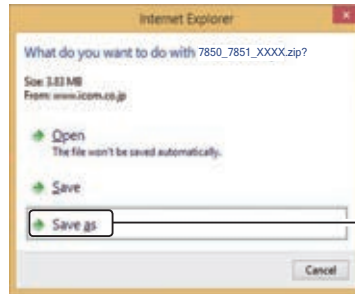

Click

- ⑦ Select the desired location where you want to save the firmware, and then click [Save] in the displayed File Download dialog.
  - File download starts.
- ⑧ After the download is completed, extract the file.
  - The firmware and the firm utility are compressed in “zip” format.
  - When updating the transceiver using with the memory device, copy the extracted firmware to the IC-7850\_7851 folder of the memory device.

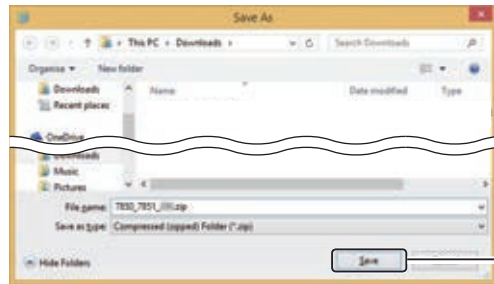

Click



## ■ Firmware update— using an SD card/USB flash drive

When updating the firmware using a memory device, no IP address as well as subnet mask settings are necessary.

- ① Copy the downloaded firmware data onto an SD card or a USB flash drive (“IC-7850\_7851” folder).
  - The memory device must be formatted by the transceiver.
- ② Insert the SD card into the [SD CARD] slot or insert the flash drive to [USB A].
- ③ On the Set mode menu screen, display the SD/USB-Memory menu screen.

**SET [F-7] ↘ SD/USB [F-7]**

- ④ Hold down [FIRMUP] for 1 second.
  - The Firmware update agreement screen is displayed. Carefully read the displayed precaution.
- ⑤ After you read and agree with all the precautions, push [OK].
  - The [OK] button appears only when you scroll down to the end of the precaution.
- ⑥ Push [SD/USB] to select between a USB flash drive and an SD card.
- ⑦ Push [▲](F) or [▼](F) to select the firmware updating data. (Example: 7850\_7851\_300.DAT)
- ⑧ Push [FIRM UP](F).
  - The Firmware update confirmation screen is displayed. Carefully read the displayed precaution on the screen.
- ⑨ After you read all the precautions, hold down [OK] for 1 second to start the firmware update.
  - The firmware update starts.
  - To cancel the update, push [CANCEL](F).

(Continued on the next page)

**CAUTION: NEVER** turn the transceiver power OFF while updating the firmware.

If you turn the transceiver power OFF, or if a power failure occurs while updating, the transceiver firmware will be damaged and you will have to send the transceiver back to the nearest Icom distributor for repair. This type of repair is out of warranty even if the warranty period is still valid.

### • Set mode menu screen



### • SD/USB-Memory menu screen

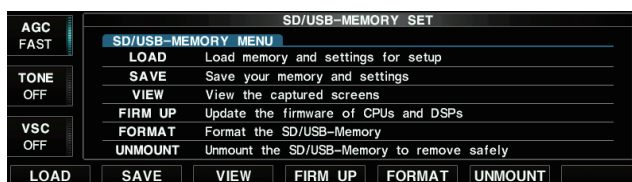

### • Firmware update agreement screen

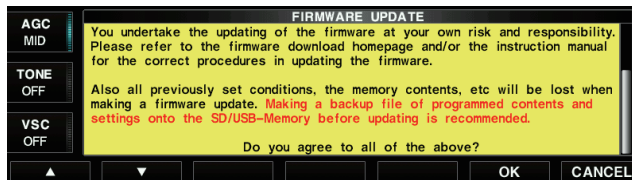

### • File selecting screen

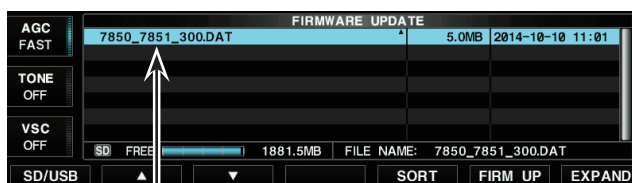

Select the firmware updating data.

### • Firmware update confirmation screen



■ Firmware update— using an SD card/USB flash drive (Continued)

- Downloads the firmware update data from the SD card or the flash drive, and then automatically loads the data onto the main CPU.
- Downloading and loading status is displayed in the “FILE LOADING” dialog.

• Firmware updating screen

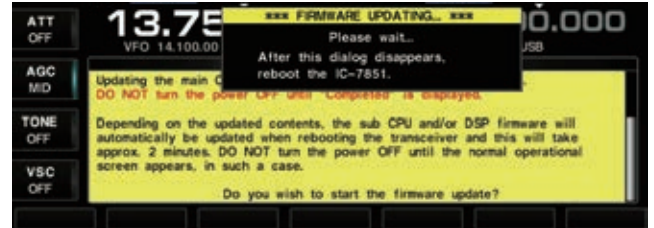
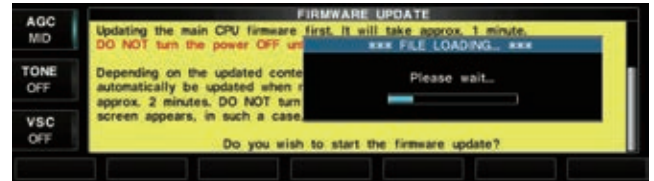

- “Firmware updating for the main CPU is completed” is displayed in the dialog.

⑩ Hold down [POWER] on the transceiver for 1 second to turn OFF the power.

• Firmware update completed screen

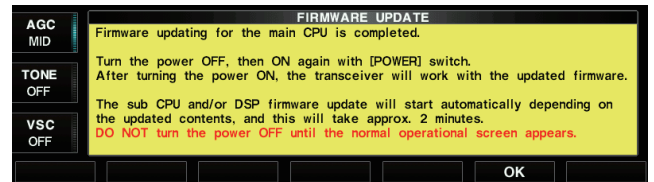

⑪ Push [POWER] to turn ON the power again.

- Depending on the updating data, the sub CPU and DSP firmware may be updated at the same time.
- While updating the firmware, one of the dialogs or all dialogs shown to the right are displayed. This will take 2 minutes at maximum.
- When the normal operation screen appears, the firmware updating is completed.



- Remote control (CI-V) information ..... 18-2
  - ◇ CI-V connection ..... 18-2
  - ◇ Preparing ..... 18-2
  - ◇ Data format..... 18-2
  - ◇ Data content description ..... 18-11

## Remote control (CI-V) information

### ◇ CI-V connection

The transceiver's operating frequency, mode, VFO and memory selection, can be remotely controlled when connecting to a PC.

Choose the connection method from the following:

- A USB cable (A-B type, user supplied)
  - The required USB driver and driver install guide can be downloaded from Icom web site.
  - Access to "<http://www.icom.co.jp/world>," then click "Support," "Firmware Updates / Software downloads" in sequence.
  - \*The download procedure on the web page may be changed without notice.
- The optional CT-17 (CI-V level converter)
  - \*Connects to a PC with an RS-232C port.
  - CT-17 accepts only an RS-232C cable. The use of an RS-232C-USB converter is not guaranteed.

### • Connection example— using CT-17

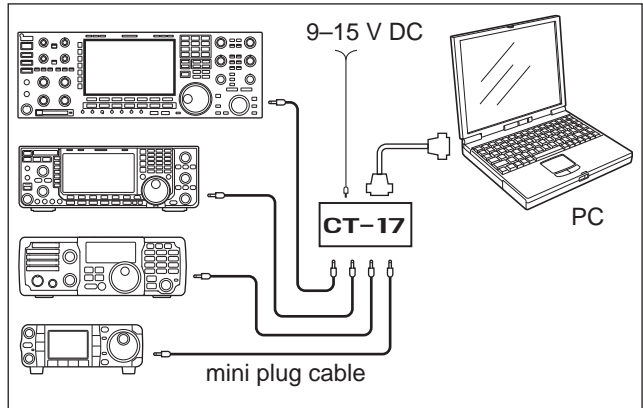

### ◇ Preparing

The Icom Communications Interface V (CI-V) is used for remote control.

To control the transceiver, first set its address, data communication speed, and transceive function.

These settings are set in the Set mode.

(pp. 15-17, 15-18)

### ◇ Data format

The CI-V system can be operated using the following data formats. Data formats differ according to command numbers. A data area or sub command is added for some commands.

#### Controller to IC-7850/IC-7851

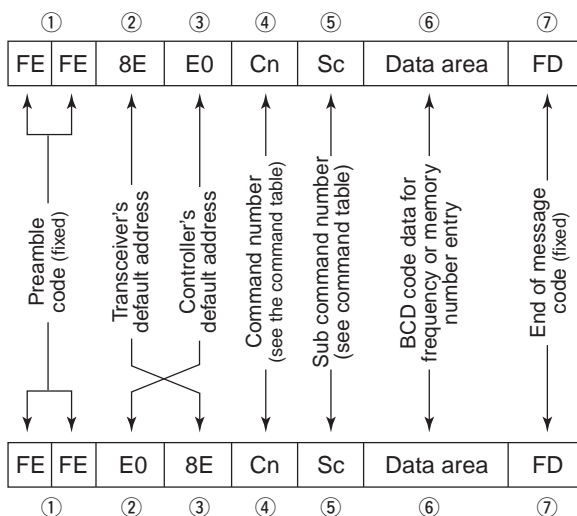

#### IC-7850/IC-7851 to controller

#### OK message to ontroller

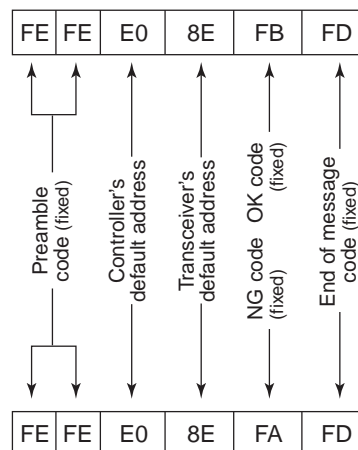

#### NG message to controller

## ◇ Command table

Cmd.	Sub Cmd.	Data	Description
00		see p. 18-11	Send frequency data (transceive)
01		see p. 18-11	Send mode data (transceive)
02		see p. 18-13	Read band edge frequencies
03		see p. 18-11	Read operating frequency
04		see p. 18-11	Read operating mode
05		see p. 18-11	Set operating frequency
06		see p. 18-11	Operating mode selection for transceive
07	29		Select VFO mode
	B0		Exchange the Main and Sub bands
	B1		Equalize the Main and Sub bands
	C2	00 or 01	Send/read the dualwatch setting (00=OFF, 01=ON) *Sub commands, C0 (dualwatch ON) and C1 (dualwatch OFF), are also usable for only setting.
	D2	00	Send/read Main band selection *Sub command, D0, is also usable for only setting.
		01	Send/read Sub band selection *Sub command, D1, is also usable for only setting.
08			Select memory mode
		0001 to 0099	Select memory channel (0001=M-CH01, 0099=M-CH99)
		0100	Select program scan edge channel P1
		0101	Select program scan edge channel P2
09			Memory write
0A			Memory to VFO
0B			Memory clear
0E	00		Scan stop
	01		Programmed/memory scan start
	02		Programmed scan start
	03		ΔF scan start
	12		Fine programmed scan start
	13		Fine ΔF scan start
	22		Memory scan start
	23		Select memory scan start
	A1		Select ΔF scan span ±5 kHz
	A2		Select ΔF scan span ±10 kHz
	A3		Select ΔF scan span ±20 kHz
	A4		Select ΔF scan span ±50 kHz
	A5		Select ΔF scan span ±100 kHz
	A6		Select ΔF scan span ±500 kHz
	A7		Select ΔF scan span ±1 MHz
	B0		Set as non-select channel
	B1		Set as select channel (The previously set number by CI-V is set after turning power ON, or "1" is selected if no selection is performed.)
		01	Set as select channel "★1"
		02	Set as select channel "★2"
		03	Set as select channel "★3"
	B2	00	Set "ALL" for select memory scan
		01	Set "★1" for select memory scan
		02	Set "★2" for select memory scan
		03	Set "★3" for select memory scan
	D0		Set scan resume OFF
	D3		Set scan resume ON
0F		00 or 01	Read split setting (00=OFF, 01=ON)
	00		Turn the split function OFF
	01		Turn the split function ON
10		00	Send/read tuning step OFF
		01	Send/read 100 Hz tuning step
		02	Send/read 1 kHz tuning step
		03	Send/read 5 kHz tuning step
		04	Send/read 9 kHz tuning step
		05	Send/read 10 kHz tuning step
		06	Send/read 12.5 kHz tuning step
		07	Send/read 20 kHz tuning step
		08	Send/read 25 kHz tuning step

Cmd.	Sub Cmd.	Data	Description
11†		00	Send/read attenuator OFF
29		03	Send/read 3 dB attenuator
		06	Send/read 6 dB attenuator
		09	Send/read 9 dB attenuator
		12	Send/read 12 dB attenuator
		15	Send/read 15 dB attenuator
		18	Send/read 18 dB attenuator
		21	Send/read 21 dB attenuator
12†	00	00 or 01	Select/read ANT1 selection (00=RX ANT OFF; 01=RX ANT ON)
29	01	00 or 01	Select/read ANT2 selection (00=RX ANT OFF; 01=RX ANT ON)
	02	00 or 01	Select/read ANT3 selection (00=RX ANT OFF; 01=RX ANT ON)
	03	00	Select/read ANT4 selection (00=RX ANT OFF; fix)
13	00		Announce all data with voice synthesizer
	01		Announce frequency and S-meter level with voice synthesizer
	02		Announce receive mode with voice synthesizer
14†	01 29	0000 to 0255	Send/read [AF] level (0000=max. CCW, 0255=max. CW)
	02 29	0000 to 0255	Send/read [RF] level (0000=max. CCW, 0255=max. CW)
	03 29	0000 to 0255	Send/read [SQL] level (0000=max. CCW, 0255=max. CW)
	05 29	0000 to 0255	Send/read [APF] position (0000=Pitch-550 Hz, 0128=Pitch, 0255=Pitch+550 Hz; 10 Hz steps)
	06 29	0000 to 0255	Send/read [NR] level (0000=0%, 0255=100%)
	07 29	0000 to 0255	Send/read inner [TWIN PBT] position (0000=max. CCW, 0128=center, 0255=max. CW)
	08 29	0000 to 0255	Send/read outer [TWIN PBT] position (0000=max. CCW, 0128=center, 0255=max. CW)
	09	0000 to 0255	Send/read CW pitch (0000=300 Hz, 0128=600 Hz, 0255=900 Hz; 5 Hz steps)
	0A	0000 to 0255	Send/read [RF PWR] position (0000=max. CCW, 0255=max. CW)
	0B	0000 to 0255	Send/read [MIC] position (0000=max. CCW, 0255=max. CW)
	0C	0000 to 0255	Send/read [KEY SPEED] level (0000=6 wpm, 0255=48 wpm)
	0D 29	0000 to 0255	Send/read [NOTCH] position (0000=max. CCW, 0128=center, 0255=max. CW)
	0E	0000 to 0255	Send/read COMP level (0000=0, 0255=10)
	0F	0000 to 0255	Send/read [DELAY] position (0000=2.0d, 0255=13.0d)
	11 29	0000 to 0255	Send/read [AGC] level (0000=max. CCW to 0255=max. CW)
	12 29	0000 to 0255	Send/read NB level (0000=0%, 0255=100%)
	13 29	0000 to 0255	Send/read [DIGI-SEL] position (0000=max. CCW to 0255=max. CW)
	14	0000 to 0255	Send/read DRIVE gain (0000=0%, 0255=100%)
	15	0000 to 0255	Send/read Monitor gain (0000=0%, 0255=100%)
	16	0000 to 0255	Send/read VOX gain (0000=0%, 0255=100%)
	17	0000 to 0255	Send/read Anti VOX gain (0000=0%, 0255=100%)
	18	0000 to 0255	Send/read [CONTRAST] position (0000=max. CCW to 0255=max. CW)
	19	0000 to 0255	Send/read BRIGHT level (0000=0%, 0255=100%)

† Send/read data, 29 Command 29 supported

# 18 CONTROL COMMAND

## ◇ Command table (continued)

Cmd.	Sub Cmd.	Data	Description	
15	01 29	00	Read noise or S-meter squelch status (squelch close)	
		01	Read noise or S-meter squelch status (squelch open)	
	02 29	0000 to 0255	Read S-meter level (0000=S0, 0120=S9, 0241=S9+60 dB)	
	05 29	00	Read various squelch (tone squelch, and so on) status (squelch close)	
		01	Read various squelch (tone squelch, and so on) status (squelch open)	
	11	0000 to 0255	Read RF power meter (0000=0 W, 0143=100 W, 0213=200 W)	
	12	0000 to 0255	Read SWR meter (0000=SWR1.0, 0048=SWR1.5, 0080=SWR2.0, 0120=SWR3.0)	
	13	0000 to 0255	Read ALC meter (0000=0, 0120=Max.)	
	14	0000 to 0255	Read COMP meter (0000=0 dB, 0130=15 dB, 0241=30 dB)	
	15	0000 to 0255	Read VD meter (0151=44 V, 0180=48 V, 0211=52 V)	
	16	0000 to 0255	Read ID meter (0000=0 A, 0165=10 A, 0241=15 A)	
	16†	02 29	00	Preamp OFF
			01	Preamp 1 ON
02			Preamp 2 ON	
12 29		00	AGC OFF selection	
		01	AGC FAST selection	
		02	AGC MID selection	
		03	AGC SLOW selection	
22 29		00	Noise blanker OFF	
		01	Noise blanker ON	
32 29		00	Audio peak filter OFF	
		01	Audio peak filter WIDE ON (320 Hz is selected when SHARP APF is set)	
		02	Audio peak filter MID ON (160 Hz is selected when SHARP APF is set)	
		03	Audio peak filter NAR ON (80 Hz is selected when SHARP APF is set)	
40 29		00	Noise reduction OFF	
		01	Noise reduction ON	
41 29		00	Auto notch function OFF	
		01	Auto notch function ON	
42 29		00	Repeater tone OFF	
		01	Repeater tone ON	
43 29		00	Tone squelch OFF	
		01	Tone squelch ON	
44		00	Speech compressor OFF	
		01	Speech compressor ON	
45		00	Monitor function OFF	
		01	Monitor function ON	
46		00	VOX function OFF	
		01	VOX function ON	
47		00	BK-IN function OFF	
		01	Semi BK-IN function ON	
		02	Full BK-IN function ON	
48 29		00	Manual notch function OFF	
	01	Manual notch function ON		
4C 29	00	VSC function OFF		
	01	VSC function ON		
4D 29	00	AGC VR function OFF		
	01	AGC VR function ON		
4E 29	00	DIGI-SEL function OFF		
	01	DIGI-SEL function ON		
4F 29	00	Twin peak filter OFF		
	01	Twin peak filter ON (Can be turned ON only when Mark and Shift are set to 2125 Hz and 170 Hz, respectively)		
50 29	00	Dial lock function OFF		
	01	Dial lock function ON		

Cmd.	Sub Cmd.	Data	Description	
16†	53 29	00	ANT-RX I/O setting OFF	
		01	ANT-RX I/O setting "A"	
		02	ANT-RX I/O setting "B"	
	55 29	00	15 kHz roofing filter selection	
		01	6 kHz roofing filter selection	
		02	3 kHz roofing filter selection	
		03	1.2 kHz roofing filter selection	
	56 29	00	SHARP selection for DSP filter type	
		01	SOFT selection for DSP filter type	
	57 29	00	WIDE selection for manual notch width	
		01	MID selection for manual notch width	
		02	NAR selection for manual notch width	
	58	00	WIDE selection for SSB transmit bandwidth	
		01	MID selection for SSB transmit bandwidth	
		02	NAR selection for SSB transmit bandwidth	
	5E	00	Main/Sub band tracking function OFF	
		01	Main/Sub band tracking function ON	
17		see p. 18-13	Send CW messages*1	
18	00		Turn OFF the transceiver	
	01		Turn ON the transceiver*2	
19	00		Read the transceiver ID	
1A†	00	see p. 18-12	Send/read memory contents	
	01	see p. 18-11	Send/read band stacking register contents	
	02	see p. 18-11	Send/read memory keyer contents	
	03 29	00 to 49		Send/read the selected filter width (AM: 00=200 Hz to 49=10 kHz; Other than AM: 00=50 Hz to 31=2700 Hz/40=3600 Hz)
		00 to 13		Send/read the selected AGC time constant (00=OFF, AM: 01=0.1 sec. to 13=6.0 sec., SSB, CW, RTTY, PSK: 01=0.3 sec. to 13=6.0/8.0 sec.)
	05	0001	see p. 18-12	Send/read SSB RX HPF/LPF settings
		0002	00 to 10	Send/read SSB RX Tone (Bass) level (00=-5 to 10=+5)
		0003	00 to 10	Send/read SSB RX Tone (Treble) level (00=-5 to 10=+5)
		0004	see p. 18-12	Send/read AM RX HPF/LPF settings
		0005	00 to 10	Send/read AM RX Tone (Bass) level (00=-5 to 10=+5)
		0006	00 to 10	Send/read AM RX Tone (Treble) level (00=-5 to 10=+5)
		0007	see p. 18-12	Send/read FM RX HPF/LPF settings
		0008	00 to 10	Send/read FM RX Tone (Bass) level (00=-5 to 10=+5)
		0009	00 to 10	Send/read FM RX Tone (Treble) level (00=-5 to 10=+5)
		0010	see p. 18-12	Send/read CW RX HPF/LPF settings
		0011	see p. 18-12	Send/read RTTY RX HPF/LPF settings
		0012	see p. 18-12	Send/read PSK RX HPF/LPF settings
		0013	00 to 10	Send/read SSB TX Tone (Bass) level (00=-5 to 10=+5)
		0014	00 to 10	Send/read SSB TX Tone (Treble) level (00=-5 to 10=+5)
		0015	00 to 10	Send/read AM TX Tone (Bass) level (00=-5 to 10=+5)
		0016	00 to 10	Send/read AM TX Tone (Treble) level (00=-5 to 10=+5)
		0017	00 to 10	Send/read FM TX Tone (Bass) level (00=-5 to 10=+5)
0018		00 to 10	Send/read FM TX Tone (Treble) level (00=-5 to 10=+5)	
0019		see p. 18-13	Send/read SSB TX bandwidth for wide	
0020		see p. 18-13	Send/read SSB TX bandwidth for mid.	
0021		see p. 18-13	Send/read SSB TX bandwidth for narrow	
0022		0000 to 0255		Send/read speech level (0000=0% to 0255=100%)

\*1 In the CW mode, if the [TRANSMIT] or an external TX switch is ON, or the Break-in function is ON, a message will be transmitted as CW code when you send it from your PC.

\*2 The power ON command (18 01) is usable only when the transceiver is in the standby mode.

† Send/read data, 29 Command 29 supported



◇ Command table (continued)

Cmd.	Sub Cmd.	Data	Description
1A†	05	0023	0000 to 0255 Send/read CW side tone gain (0000=0% to 0255=100%)
		0024	00 or 01 Send/read CW side tone gain limit (00=OFF, 01=ON)
		0025	00 to 06 Send/read audio output level at APF ON (00=0 dB, 06=+6 dB)
		0026	0000 to 0255 Send/read beep gain (0000=min. to 0255=max.)
		0027	00 or 01 Send/read beep gain limit (00=OFF, 01=ON)
		0028	00 to 30 Send/read headphones output ratio for the volume level (00=-15 dB to 30=+15 dB)
		0029	00 or 01 Send/read headphone output selection (00=separated, 01=mixed)
		0030	00 or 01 Send/read AF/SQL signal output to ACC-A (00=MAIN; 01=SUB)
		0031	00 or 01 Send/read AF/SQL signal output to ACC-B (00=MAIN; 01=SUB)
		0032	00 or 01 Send/read AF/IF signal output to ACC-A (00=AF; 01=IF)
		0033	00 or 01 Send/read the band selection for AF/IF signal output to ACC-A (While holding down [XFC] during split frequency operation) (00=Main band, 01=Sub band)
		0034	0000 to 0255 Send/read AF output level to ACC-A (0000=0% to 0255=100%)
		0035	00 or 01 Send/read squelch function for the AF signal output to ACC-A (00=OFF (Open), 01=ON)
		0036	00 or 01 Send/read voice synthesizer and beep output setting to ACC-A (when audio output is set) (00=OFF, 01=ON)
		0037	0000 to 0255 Send/read IF signal output level to ACC-A (0000=0%, 0255=100%)
		0038	00 or 01 Send/read AF/IF signal output to ACC-B (00=AF; 01=IF)
		0039	00 or 01 Send/read the band selection for AF/IF signal output to ACC-B (While holding down [XFC] during split frequency operation) (00=Main band, 01=Sub band)
		0040	0000 to 0255 Send/read AF output level to ACC-B (0000=0% to 0255=100%)
		0041	00 or 01 Send/read squelch function for the AF signal output to ACC-B (00=OFF (Open), 01=ON)
		0042	00 or 01 Send/read voice synthesizer and beep output setting to ACC-B (when audio output is set) (00=OFF, 01=ON)
		0043	0000 to 0255 Send/read IF signal output level to ACC-B (0000=0%, 0255=100%)
		0044	00 or 01 Send/read AF/IF signal output to S/P DIF (00=AF, 01=IF)
		0045	00 or 01 Send/read the band selection for AF/IF signal output to S/P DIF (While holding down [XFC] during split frequency operation) (00=Main band, 01=Sub band)
		0046	0000 to 0255 Send/read AF output level to S/P DIF (0000=0% to 0255=100%)
		0047	00 or 01 Send/read squelch function for the AF signal output to S/P DIF (00=OFF (Open), 01=ON)
		0048	00 or 01 Send/read voice synthesizer and beep output setting to S/P DIF (when audio output is set) (00=OFF, 01=ON)
		0049	0000 to 0255 Send/read IF signal output level to S/P DIF (0000=0%, 0255=100%)
		0050	00 or 01 Send/read AF/IF signal output to USB B (00=AF, 01=IF)
		0051	00 or 01 Send/read the band selection for AF/IF signal output to USB B (While holding down [XFC] during split frequency operation) (00=Main band, 01=Sub band)
		0052	0000 to 0255 Send/read AF output level to USB B (0000=0% to 0255=100%)

† Send/read data

Cmd.	Sub Cmd.	Data	Description
1A†	05	0053	00 or 01 Send/read squelch function for the AF signal output to USB B (00=OFF (Open), 01=ON)
		0054	00 or 01 Send/read voice synthesizer and beep output setting to USB B (when audio output is set) (00=OFF, 01=ON)
		0055	0000 to 0255 Send/read IF signal output level to USB B (0000=0%, 0255=100%)
		0056	00 or 01 Send/read AF/IF signal output to LAN (00=AF, 01=IF)
		0057	00 or 01 Send/read the band selection for AF/IF signal output to LAN (While holding down [XFC] during split frequency operation) (00=Main band, 01=Sub band)
		0058	0000 to 0255 Send/read MOD input level from ACC-A (0000=0% to 0255=100%)
		0059	0000 to 0255 Send/read MOD input level from ACC-B (0000=0% to 0255=100%)
		0060	0000 to 0255 Send/read MOD input level from S/P DIF (0000=0% to 0255=100%)
		0061	0000 to 0255 Send/read MOD input level from USB B (0000=0% to 0255=100%)
		0062	0000 to 0255 Send/read MOD input level from LAN (0000=0% to 0255=100%)
		0063	00 to 10 Send/read MOD input connector during DATA OFF (00=MIC, 01=ACC-A, 02=ACC-B, 03=MIC/ACC-A, 04=MIC/ACC-B, 05=ACC-A/ACC-B, 06=MIC/ACCA/ACC-B, 07=S/P DIF, 08=USB, 09=LAN, 10=MIC/USB)
		0064	00 to 10 Send/read MOD input connector during DATA1 (00=MIC, 01=ACC-A, 02=ACC-B, 03=MIC/ACC-A, 04=MIC/ACC-B, 05=ACC-A/ACC-B, 06=MIC/ACCA/ACC-B, 07=S/P DIF, 08=USB, 09=LAN, 10=MIC/USB)
		0065	00 to 10 Send/read MOD input connector during DATA2 (00=MIC, 01=ACC-A, 02=ACC-B, 03=MIC/ACC-A, 04=MIC/ACC-B, 05=ACC-A/ACC-B, 06=MIC/ACCA/ACC-B, 07=S/P DIF, 08=USB, 09=LAN, 10=MIC/USB)
		0066	00 to 10 Send/read MOD input connector during DATA3 (00=MIC, 01=ACC-A, 02=ACC-B, 03=MIC/ACC-A, 04=MIC/ACC-B, 05=ACC-A/ACC-B, 06=MIC/ACCA/ACC-B, 07=S/P DIF, 08=USB, 09=LAN, 10=MIC/USB)
		0067	00 to 02 Send/read the band selection for operating frequency band signal output to ACC-A (00=MAIN, 01=SUB, 02=TX)
		0068	00 to 02 Send/read the band selection for operating frequency band signal output to ACC-B (00=MAIN, 01=SUB, 02=TX)
		0069	00 or 01 Send/read relay type selection (00=Reed, 01=MOS-FET)
		0070	00 to 07 Send/read the Main band's external meter output selection (00=Auto, 01=S (Main), 02=Po, 03=SWR, 04=ALC, 05=COMP, 06=VD, 07=ID)
		0071	00 to 07 Send/read the Sub band's external meter output selection (00=Auto, 01=S (Sub), 02=Po, 03=SWR, 04=ALC, 05=COMP, 06=VD, 07=ID)
		0072	0000 to 0255 Send/read the Main band's external meter output level (0000=0% to 0255=100%)
		0073	0000 to 0255 Send/read the Sub band's external meter output level (0000=0% to 0255=100%)
		0074	00 to 02 Send/read reference signal in/out setting (00=IN, 01=OFF, 02=OUT)
		0075	0000 to 0255 Send/read reference signal frequency setting (0000=0% to 0255=100%)
		0076	0000 to 0255 Send/read LCD unit backlight brightness (0000=0% to 0255=100%)
		0077	0000 to 0255 Send/read switch indicator brightness (0000=1 to 0255=100)

# 18 CONTROL COMMAND

## ◇ Command table (continued)

Cmd.	Sub Cmd.	Data	Description
1A†	05	0078	00 to 02 Send/read screen image type (00=A, 01=B, 02=50th Anniversary for only IC-7850)
		0079	00 to 08 Send/read frequency readout font (00=Basic (1), 01=Basic (2), 02=Basic (3), 03=Italic (1), 04=Italic (2), 05=Italic (3), 06=Round (1), 07=Round (2), 08=Round (3))
		0080	00 to 02 Send/Read response speed for Standard and Edgewise meter needle (00=Slow, 01=Mid, 02=Fast)
		0081	00 to 02 Send/read meter type (00=Standard, 01=Edgewise, 02=Bar)
		0082	00 or 01 Send/read meter type during expanded screen (00=Edgewise, 01=Bar)
		0083	00 or 01 Send/read peak hold set for Bar meter (00=OFF, 01=ON)
		0084	00 or 01 Send/read memory name indication setting (00=OFF, 01=ON)
		0085	00 or 01 Send/read audio peak filter width popup indication setting (00=OFF, 01=ON)
		0086	00 or 01 Send/read manual notch width pop-up indication setting (00=OFF, 01=ON)
		0087	00 to 03 Send/read screen saver function (00=OFF, 01=15 minutes, 02=30 minutes, 03=60 minutes)
		0088	00 to 03 Send/read screen saver type (00=Bounce, 01=Rotation, 02=Twist, 03=Sleep)
		0089	00 or 01 Send/read output signal setting for external display (00=OFF, 01=ON)
		0090	00 or 01 Send/read flame rate shift setting for external display (00=OFF, 01=ON)
		0091	00 or 01 Send/read image resolution for external display (00=800x480, 01=800x600)
		0092	00 or 01 Send/read synchronous pulse level setting (00=L, 01=H)
		0093	00 or 01 Send/read opening message indication (00=OFF, 01=ON)
		0094	see p. 18-12 Send/read opening message contents (up to 10-character)
		0095	20000101 to 20991231 Send/read date (20000101=1st Jan. 2000 to 20991231=31st Dec. 2099)
		0096	0000 to 2359 Send/read time (0000=00:00 to 2359=23:59)
		0097	00 or 01 Send/read NTP (Network Time Protocol) function setting (00=OFF, 01=ON)
		0098	see p. 18-12 Send/read NTP server address setting
		0099	see p. 18-11 Send/read UTC offset time
		0100	00 or 01 Send/read CLOCK2 function (00=OFF, 01=ON)
		0101	see p. 18-11 Send/read UTC offset time for CLOCK2
		0102	see p. 18-12 Send/read CLOCK2 name (up to 3-character)
		0103	00 or 01 Send/read calibration marker (00=OFF, 01=ON)
		0104	00 or 01 Send/read confirmation beep (00=OFF, 01=ON)
		0105	00 Send/read the band edge beep OFF
		01	Send/read the band edge beep ON (Beep sounds with a default amateur band)
		02	Send/read the band edge beep with user setting ON
		03	Send/read the band edge beep with user setting/TX limit ON
		0106	0050 to 0200 Send/read the Main band's beep audio frequency (0050=500 Hz to 0200=2000 Hz)
		0107	0050 to 0200 Send/read the Sub band's beep audio frequency (0050=500 Hz to 0200=2000 Hz)
		0108	00 or 01 Send/read TX output power limit function (00=OFF, 01=ON)

† Send/read data

Cmd.	Sub Cmd.	Data	Description
1A†	05	0109	00 to 05 Send/read the TX Delay setting (HF) (00=OFF, 01=10 ms, 02=15 ms, 03=20 ms, 04=25 ms, 05=30 ms)
		0110	00 to 05 Send/read the TX Delay setting (50 MHz) (00=OFF, 01=10 ms, 02=15 ms, 03=20 ms, 04=25 ms, 05=30 ms)
		0111	00 to 05 Send/read TOT setting for remote or the [TRANSMIT] key operation (00=OFF, 01=3 minutes, 02=5 minutes, 03=10 minutes, 04=20 minutes, 05=30 minutes)
		0112	00 or 01 Send/read quick dualwatch function (00=OFF, 01=ON)
		0113	00 or 01 Send/read quick split set (00=OFF, 01=ON)
		0114	see p. 18-12 Send/read FM split offset -9.999 to +9.999 MHz for HF
		0115	see p. 18-12 Send/read FM split offset -9.999 to +9.999 MHz for 50 MHz
		0116	00 or 01 Send/read split lock set (00=OFF, 01=ON)
		0117	00 or 01 Send/read tuner auto start set (00=OFF, 01=ON)
		0118	00 or 01 Send/read PTT tune set (00=OFF, 01=ON)
		0119	00 or 01 Send/read transverter set (00=OFF, 01=ON)
		0120	see p. 18-12 Send/read transverter offset
		0121	00 to 02 Send/read RTTY mark frequency (00=1275 Hz, 01=1615 Hz, 02=2125 Hz)
		0122	00 to 02 Send/read RTTY shift width (00=170 Hz, 01=200 Hz, 02=425 Hz)
		0123	00 or 01 Send/read RTTY keying polarity (00=Normal, 01=Reverse)
		0124	00 to 02 Send/read PSK tone frequency (00=1000 Hz, 01=1500 Hz, 02=2000 Hz)
		0125	00 or 01 Send/read speech language (00=English, 01=Japanese)
		0126	00 or 01 Send/read speech speed (00=Low, 01=High)
		0127	00 or 01 Send/read S-level speech (00=OFF, 01=ON)
		0128	00 or 01 Send/read speech with a mode switch operation (00=OFF, 01=ON)
		0129	00 or 01 Send/read memo pad numbers (00=5 ch, 01=10 ch)
		0130	00 or 01 Send/read [MAIN DIAL] function (00=MAIN, 01=MAIN+SUB)
		0131	00 to 02 Send/read [MAIN DIAL] auto TS (00=OFF, 01=Low, 02=High)
		0132	00 to 02 Send/read [SUB DIAL] auto TS (00=OFF, 01=Low, 02=High)
		0133	00 or 01 Send/read mic. up/down speed (00=Low, 01=High)
		0134	00 or 01 Send/read quick RIT/ΔTX clear function (00=OFF, 01=ON)
		0135	00 to 02 Send/read SSB notch operation (00=Auto, 01=Manual, 02=Auto/Manual)
		0136	00 to 02 Send/read AM notch operation (00=Auto, 01=Manual, 02=Auto/Manual)
		0137	00 or 01 Send/read DIGI-SEL control function (00=DIGI-SEL, 01=APF)
		0138	00 or 01 Send/read band indication for Filter screen (00=Fix, 01=Auto)
		0139	00 or 01 Send/read SSB/CW synchronous tuning function (00=OFF, 01=ON)
		0140	00 or 01 Send/read CW normal side set (00=LSB, 01=USB)
		0141	00 or 01 Set/read APF type (00=SHARP, 01=SOFT)
		0142	00 or 01 Send/read band setting for audio output from mic. connector (00=MAIN+SUB, 01=SUB)
		0143	00 or 01 Send/read bias voltage output for mic. audio input ([MIC]; pin 1) (00=OFF, 01=ON)
		0144	00 or 01 Send/read external keypad set for RTTY memory (00=OFF, 01=ON)
		0145	00 or 01 Send/read external keypad set for PSK memory (00=OFF, 01=ON)
		0146	00 or 01 Send/read the voice memory transmission set for [F1] to [F8] on the keyboard (00=OFF, 01=ON)

## ◇ Command table (continued)

Cmd.	Sub Cmd.	Data	Description
1A†	05	0147	00 or 01 Send/read the memory keyer transmission set for [F1] to [F8] on the keyboard (00=OFF, 01=ON)
		0148	00 or 01 Send/read external keypad set for voice memory (00=OFF, 01=ON)
		0149	00 or 01 Send/read external keypad set for memory keyer (00=OFF, 01=ON)
		0150	00 or 01 Send/read screen capture by the [POWER] switch (00=OFF, 01=ON)
		0151	00 or 01 Send/read screen capture by the [Print Screen] key on the keyboard (00=OFF, 01=ON)
		0152	00 or 01 Send/read captured screen image data saving memory device (00=SD card, 01=USB flash drive)
		0153	00 or 01 Send/read screen capture image data saving format (00=PNG format, 01=BMP format)
		0154	00 or 01 Send/read the Shutdown function (00=Shutdown, 01=Standby/Shutdown)
		0155	00 or 01 Send/read CI-V transceiver set (00=OFF, 01=ON)
		0156	0000 to 0223 Send/read the transceiver CI-V Address for LAN to REMOTE in hexadecimal code (0000=00h to 0223=DFh)
		0157	00 or 01 Send/read antenna controller status (frequency, and so on) data output from [REMOTE] (00=OFF, 01=ON)
		0158	00 or 01 Send/read echo back setting for CI-V operation (00=OFF, 01=ON)
		0159	00 to 03 Send/read data transfer speed for RTTY or PSK decode output from USB B (00=4800 bps, 01=9600 bps, 02=19200 bps, 03=38400 bps)
		0160	00 to 04 Send/read transmission control line setting for USB B (00=OFF, 01=USB1 DTR, 02=USB1 RTS, 03=USB2 DTR, 04=USB2 RTS) *Different line must be set from both CW keying and RTTY (FSK)
		0161	00 to 04 Send/read CW keying line setting for USB B (00=OFF, 01=USB1 DTR, 02=USB1 RTS, 03=USB2 DTR, 04=USB2 RTS) *Different line must be set from transmission control
		0162	00 to 04 Send/read RTTY (FSK) line setting for USB B (00=OFF, 01=USB1 DTR, 02=USB1 RTS, 03=USB2 DTR, 04=USB2 RTS) *Different line must be set from transmission control
		0163	00 to 10 Send/read keyboard type (00=English, 01=Japanese, 02=United Kingdom, 03=French, 04=French (Canadian), 05=German, 06=Portuguese, 07=Portuguese (Brazilian), 08=Spanish, 09=Spanish (Latin American), 10=Italian)
		0164	0010 to 0100 Send/read keyboard repeat delay (0010=100 msec., 0100=1000 msec.; 50 msec. steps)
		0165	00 to 31 Send/read keyboard repeat rate (00=2.0 cps to 31=30.0 cps)
		0166	00 to 02 Send/read mouse pointer speed (00=Slow, 01=Mid, 02=Fast)
		0167	00 or 01 Send/read mouse pointer speed acceleration (00=OFF, 01=ON)
		0168	00 or 01 Send/read DHCP client setting (auto IP address setting using DHCP server) (00=OFF, 01=ON)
		0169	Send/read IP address setting (fixed setting) (0000000000000001 (0.0.0.1) to 0255025502550254 (255.255.255.254)) *Usable when the DHCP client setting is OFF

† Send/read data

Cmd.	Sub Cmd.	Data	Description
1A†	05	0170	Read the IP address set by the DHCP server (0000000000000001 (0.0.0.1) to 0255025502550254 (255.255.255.254)) *If the DHCP client setting is OFF, sends back the manually set IP address (fixed IP address)
		0171	01 to 30 Send/read subnet mask (01=128.0.0.0 to 30=255.255.255.252)
		0172	Send/read default gateway (0000000000000001 (0.0.0.1) to 0255025502550254 (255.255.255.254), FF=Blank) *Usable when the DHCP client setting is OFF
		0173	Send/read primary DNS (Domain Name System) server address (0000000000000001 (0.0.0.1) to 0255025502550254 (255.255.255.254), FF=Blank) *Usable when the DHCP client setting is OFF
		0174	Send/read secondly DNS (Domain Name System) server address (0000000000000001 (0.0.0.1) to 0255025502550254 (255.255.255.254), FF=Blank) *Usable when the DHCP client setting is OFF
		0175	see p. 18-12 Send/read network name when remotely operating using the optional RS-BA1 (up to 15-character)
		0176	00 or 01 Send/read the remote control setting (00=OFF, 01=ON)
		0177	000001 to 065535 Send/read the control port setting by accessing from internet (000001=1 to 065535=65535)
		0178	000001 to 065535 Send/read the serial port setting by accessing from internet (000001=1 to 065535=65535)
		0179	000001 to 065535 Send/read the audio port setting by accessing from internet (000001=1 to 065535=65535)
		0180	00 or 01 Send/read the internet access line setting (00=FTTH (Fiber To The Home), 01=ADSL/CATV)
		0181	see p. 18-12 Send/read Network radio name (up to 16-character)
		0182	00 or 01 Send/read scope indication during TX (00=OFF, 01=ON)
		0183	00 to 02 Send/read scope max. hold (00=OFF, 01=ON)
		0184	00 to 02 Send/read scope center frequency set (00=Filter center, 01=Carrier point center, 02=Carrier point center (Abs. Freq.))
		0185	00 or 01 Send/read scope marker position setting during fix type scope (00=Filter center, 01 Carrier point)
		0186	00 or 01 Send/read external monitor signal width (00=Narrow, 01=Wide)
		0187	00 to 03 Send/read averaging function for spectrum scope (00=OFF, 01=Averaging the two observations, 02=Averaging the three observations, 03=Averaging the four observations)
		0188	00 or 01 Send/read spectrum display type (00=Fill, 01=Fill+Line)
		0189	see p. 18-12 Send/read spectrum fill color
		0190	see p. 18-12 Send/read spectrum line color
		0191	see p. 18-12 Send/read spectrum color for peak hold
		0192	00 or 01 Send/read waterfall set for spectrum scope (00=OFF, 01=ON)
		0193	00 to 02 Send/read waterfall speed (00=Slow, 01=Mid, 02=Fast)
		0194	00 to 02 Send/read waterfall height when expanded scope is selected (00=Small, 01=Mid, 02=Larger)

# 18 CONTROL COMMAND

## ◇ Command table (continued)

Cmd.	Sub Cmd.	Data	Description
1A†	05	0195	00 to 09 Send/read peak color level set for waterfall of the spectrum scope (00=Grid 1, 01=Grid 2, 02=Grid 3, 03=Grid 4, 04=Grid 5, 05=Grid 6, 06=Grid 7, 07=Grid 8, 08=Grid 9, 09=Grid 10)
		0196	00 or 01 Send/read the Main and Sub scope screen arrangement during dual scope (00=Up and down, 01=Left and right)
		0197	00 or 01 Send/read the Main/Sub scope access setting linked to the [MAIN]/[SUB] key operation (00=OFF, 01=ON)
		0198	see p. 18-12 Send/read scope edge 1 frequencies for 0.03 to 1.60 MHz band
		0199	see p. 18-12 Send/read scope edge 2 frequencies for 0.03 to 1.60 MHz band
		0200	see p. 18-12 Send/read scope edge 3 frequencies for 0.03 to 1.60 MHz band
		0201	see p. 18-12 Send/read scope edge 1 frequencies for 1.60 to 2.00 MHz band
		0202	see p. 18-12 Send/read scope edge 2 frequencies for 1.60 to 2.00 MHz band
		0203	see p. 18-12 Send/read scope edge 3 frequencies for 1.60 to 2.00 MHz band
		0204	see p. 18-12 Send/read scope edge 1 frequencies for 2.00 to 6.00 MHz band
		0205	see p. 18-12 Send/read scope edge 2 frequencies for 2.00 to 6.00 MHz band
		0206	see p. 18-12 Send/read scope edge 3 frequencies for 2.00 to 6.00 MHz band
		0207	see p. 18-12 Send/read scope edge 1 frequencies for 6.00 to 8.00 MHz band
		0208	see p. 18-12 Send/read scope edge 2 frequencies for 6.00 to 8.00 MHz band
		0209	see p. 18-12 Send/read scope edge 3 frequencies for 6.00 to 8.00 MHz band
		0210	see p. 18-12 Send/read scope edge 1 frequencies for 8.00 to 11.00 MHz band
		0211	see p. 18-12 Send/read scope edge 2 frequencies for 8.00 to 11.00 MHz band
		0212	see p. 18-12 Send/read scope edge 3 frequencies for 8.00 to 11.00 MHz band
		0213	see p. 18-12 Send/read scope edge 1 frequencies for 11.00 to 15.00 MHz band
		0214	see p. 18-12 Send/read scope edge 2 frequencies for 11.00 to 15.00 MHz band
		0215	see p. 18-12 Send/read scope edge 3 frequencies for 11.00 to 15.00 MHz band
		0216	see p. 18-12 Send/read scope edge 1 frequencies for 15.00 to 20.00 MHz band
		0217	see p. 18-12 Send/read scope edge 2 frequencies for 15.00 to 20.00 MHz band
		0218	see p. 18-12 Send/read scope edge 3 frequencies for 15.00 to 20.00 MHz band
		0219	see p. 18-12 Send/read scope edge 1 frequencies for 20.00 to 22.00 MHz band
		0220	see p. 18-12 Send/read scope edge 2 frequencies for 20.00 to 22.00 MHz band
		0221	see p. 18-12 Send/read scope edge 3 frequencies for 20.00 to 22.00 MHz band
		0222	see p. 18-12 Send/read scope edge 1 frequencies for 22.00 to 26.00 MHz band
		0223	see p. 18-12 Send/read scope edge 2 frequencies for 22.00 to 26.00 MHz band
		0224	see p. 18-12 Send/read scope edge 3 frequencies for 22.00 to 26.00 MHz band
		0225	see p. 18-12 Send/read scope edge 1 frequencies for 26.00 to 30.00 MHz band
		0226	see p. 18-12 Send/read scope edge 2 frequencies for 26.00 to 30.00 MHz band
		0227	see p. 18-12 Send/read scope edge 3 frequencies for 26.00 to 30.00 MHz band
		0228	see p. 18-12 Send/read scope edge 1 frequencies for 30.00 to 45.00 MHz band

Cmd.	Sub Cmd.	Data	Description
1A†	05	0229	see p. 18-12 Send/read scope edge 2 frequencies for 30.00 to 45.00 MHz band
		0230	see p. 18-12 Send/read scope edge 2 frequencies for 30.00 to 45.00 MHz band
		0231	see p. 18-12 Send/read scope edge 1 frequencies for 45.00 to 60.00 MHz band
		0232	see p. 18-12 Send/read scope edge 2 frequencies for 45.00 to 60.00 MHz band
		0233	see p. 18-12 Send/read scope edge 3 frequencies for 45.00 to 60.00 MHz band
		0234	00 or 01 Send/read the voice 1st menu. (00=VOICE-Root, 01=VOICE-PLAY)
		0235	00 or 01 Send/read the auto monitor function setting when transmitting a recorded voice memory (00=OFF, 01=ON)
		0236	01 to 15 Send/read the repeat interval to transmit the recorded voice audio (01=1 sec. to 15=15 sec.)
		0237	00 or 01 Send/read the QSO recording device setting (00=SD card, 01=USB flash drive)
		0238	00 or 01 Send/read the recording mode. (00=TX&RX, 01=RX Only)
		0239	00 or 01 Send/read recording TX audio for the QSO recorder (00=Microphone audio, 01=TX monitor audio)
		0240	00 or 01 Send/read the squelch relation to recording RX audio for the QSO recorder (00=Always, 01=Squelch Auto)
		0241	00 or 01 Send/read the QSO record file split function setting (00=OFF, 01=ON)
		0242	00 or 01 Send/read the PTT Automatic Recording function setting (00=OFF, 01=ON)
		0243	00 to 03 Send/read the RX audio recording status for the PTT Automatic Recording function (00=OFF (records no RX audio), 01=Records the RX audio just before 5 sec., 02=Records the RX audio just before 10 sec., 03=Records the RX audio just before 15 sec.)
		0244	00 to 03 Send/read QSO PLAY Skip time (00=3 sec., 01=5 sec., 02=10 sec., 03=30 sec.)
		0245	05 to 30 Send/read the instant record time when [REC] is pushed (05=5 sec. to 30=30 sec.)
		0246	03 to 10 Send/read the instant playback time when [PLAY] is pushed (03=3 sec. to 10=10 sec.)
		0247	00 Normal selection for contest number style
		01	"190→ANO" selection for contest number style
		02	"190→ANT" selection for contest number style
		03	"90→NO" selection for contest number style
		04	"90→NT" selection for contest number style
		0248	01 to 08 Send/read count up trigger channel (01=M1, 02=M2, 03=M3, 04=M4, 05=M5, 06=M6, 07=M7, 08=M8)
		0249	0001 to 9999 Send/read present number (0001=1 to 9999=9999)
		0250	01 to 60 Send/read CW keyer repeat time (01=1 sec. to 60=60 sec.)
		0251	28 to 45 Send/read CW keyer dot/dash ratio (28=1:1.2:8 to 45=1:1:4.5)
		0252	00 to 03 Send/read rise time (00=2 msec., 01=4 msec., 02=6 msec., 03=8 msec.)
		0253	00 or 01 Send/read paddle polarity (00=Normal, 01=Reverse)
		0254	00 to 02 Send/read keyer type (00=Straight, 01=Bug-key, 02=ELEC-Key)
		0255	00 or 01 Send/read mic. up/down keyer set (00=OFF, 01=ON)

† Send/read data



## ◇ Command table (continued)

Cmd.	Sub Cmd.	Data	Description
1A†	05	0256	00 to 03 Send/read averaging function for RTTY FFT scope (00=OFF, 01=Averaging the two observations, 02=Averaging the three observations, 03=Averaging the four observations)
		0257	see p. 18-12 Send/read RTTY FFT scope waveform color
		0258	00 or 01 Send/read RTTY decode USOS (00=OFF, 01=ON)
		0259	00 or 01 Send/read RTTY decode new line code (00=CR,LF,CR+LF, 01=CR+LF)
		0260	00 to 02 Send/read RTTY diddle (00=OFF, 01=Blank, 02=LTRS (Letter code))
		0261	00 or 01 Send/read RTTY TX USOS (00=OFF, 01=ON)
		0262	00 or 01 Send/read RTTY auto CR+LF by TX using the [F12] key on the keyboard (00=OFF, 01=ON)
		0263	00 or 01 Send/read RTTY time stamp set (00=OFF, 01=ON)
		0264	00 or 01 Send/read clock selection for RTTY time stamp (0=Local time, 1=CLOCK2)
		0265	00 or 01 Send/read RTTY frequency stamp (00=OFF, 01=ON)
		0266	see p. 18-12 Send/read received RTTY text font color
		0267	see p. 18-12 Send/read transmitted RTTY text font color
		0268	see p. 18-12 Send/read RTTY time stamp text font color
		0269	see p. 18-12 Send/read text font color in RTTY TX buffer
		0270	00 or 01 Send/read the RTTY log function (00=OFF, 01=ON)
		0271	00 or 01 Send/read the file saving format for the RTTY log (00=Text, 01=HTML)
		0272	00 or 01 Send/read the file saving memory device for the RTTY log (00=SD card, 01=USB flash drive)
		0273	00 to 03 Send/read averaging function for PSK FFT scope (00=OFF, 01=Averaging the two observations, 02=Averaging the three observations, 03=Averaging the four observations)
		0274	see p. 18-12 Send/read PSK FFT scope waveform color
		0275	00 or 01 Set/read PSK AFC function tuning range (00=±8 Hz, 01=±15 Hz)
		0276	00 or 01 Send/read PSK time stamp set (00=OFF, 01=ON)
		0277	00 or 01 Send/read clock selection for PSK time stamp (0=Local time, 1=CLOCK2)
		0278	00 or 01 Send/read PSK frequency stamp (00=OFF, 01=ON)
		0279	see p. 18-12 Send/read received PSK text font color
		0280	see p. 18-12 Send/read transmitted PSK text font color
		0281	see p. 18-12 Send/read PSK time stamp text font color
		0282	see p. 18-12 Send/read text font color in PSK TX buffer
		0283	00 or 01 Send/read the PSK log function (00=OFF, 01=ON)
		0284	00 or 01 Send/read the file saving format for the PSK log (00=Text, 01=HTML)
		0285	00 or 01 Send/read the file saving memory device for the PSK log (00=SD card, 01=USB flash drive)
		0286	00 or 01 Send/read scan speed (00=Low, 01=High)
		0287	00 or 01 Send/read scan resume (00=OFF, 01=ON)
		0288	00 or 01 Send/read audio FFT scope display type (00=Fill, 01=Fill+Line)
		0289	see p. 18-12 Send/read the Audio FFT scope waveform color
		0290	00 or 01 Send/read the Audio FFT scope waterfall display (00=OFF, 01=ON)
		0291	see p. 18-12 Send/read the Audio Oscilloscope scope waveform color
		0292	see p. 18-13 Send/read antenna selection for 0.03 to 1.60 MHz band

Cmd.	Sub Cmd.	Data	Description
1A†	05	0293	see p. 18-13 Send/read antenna selection for 1.60 to 2.00 MHz band
		0294	see p. 18-13 Send/read antenna selection for 2.00 to 6.00 MHz band
		0295	see p. 18-13 Send/read antenna selection for 6.00 to 8.00 MHz band
		0296	see p. 18-13 Send/read antenna selection for 8.00 to 11.00 MHz band
		0297	see p. 18-13 Send/read antenna selection for 11.00 to 15.00 MHz band
		0298	see p. 18-13 Send/read antenna selection for 15.00 to 20.00 MHz band
		0299	see p. 18-13 Send/read antenna selection for 20.00 to 22.00 MHz band
		0300	see p. 18-13 Send/read antenna selection for 22.00 to 26.00 MHz band
		0301	see p. 18-13 Send/read antenna selection for 26.00 to 30.00 MHz band
		0302	see p. 18-13 Send/read antenna selection for 30.00 to 45.00 MHz band
		0303	see p. 18-13 Send/read antenna selection for 45.00 to 60.00 MHz band
		0304	00 or 01 Send/read antenna temporary memory set (00=OFF, 01=ON)
		0305	00 to 02 Send/read antenna selection (00=[ANT]: Auto/[RX-I/O]: Auto, 01=[ANT]: Auto/[RX-I/O]: Manual, 02=[ANT]: Manual/[RX-I/O]: Manual)
		0306	00 or 01 Send/read usage for ANT2 (00=OFF, 01=TX/RX)
		0307	00 or 01 Send/read usage for ANT3 (00=OFF, 01=TX/RX)
		0308	00 to 02 Send/read usage for ANT4 (00=OFF, 01=TX/RX, 02= RX)
		0309	00 to 20 Send/read VOX delay (00=0.0 sec. to 20=2.0 sec.)
		0310	00 to 03 Send/read VOX voice delay ( 00=OFF, 01=Short, 02=Mid., 03=Long)
		0311	00 to 09 Send/read NB depth (00=1 to 09=10)
		0312	0000 to 0255 Send/read NB width (0000=1 to 0255=100)
		0313	00 or 01 Read the CI-V command link setting with [REMOTE] for USB port 00=Link to [REMOTE], 01=Unlink from [REMOTE]
		0314	00 or 01 MAIN/SUB band Tracking function is enable or disabled. 00=MAIN/SUB Tracking function is disabled. 01=Assigns the function to the [MAIN] key
		0315	00 or 01 Send/read the Waterfall Marker Auto-hide set (00=OFF, 01=ON)
		0316	00 or 01 Send/read the RC-28's main dial function. (00=Sub only, 01=Main/Sub)
		0317	00 to 02 Send/read the Auto TS setting on the RC-28's main dial. (00=OFF, 01=Low, 02=High)
		0318	00 or 01 Send/read the [TRANSMIT] key action on the RC-28. (00=Push to toggle, 01=Hold down to transmit)
		0319	0000 to 0255 Send/read the Transmit voice level for the VOICE TX function. (0000=0% to 0255=100%)
		0320	see p. 18-13 Send/read the transmission passband width for the SSB-D mode.
		0321	00/01 Send/read the timer setting of the USB SEND/Keying Inhibit at Connection. (00=OFF, 01=ON)
	06	see p. 18-12	Send/read DATA mode with filter set
	07	29	00 or 01 Send/read 1.2 kHz filter calibration (00=Stop, 01=Start)
	08	29	00 to 02 Read 1.2 kHz filter calibration result (00=Calibrating, or has not been calibrated after Power ON, 01=Succeeded, 02=Failed)
	09	29	0000 to 0440 Send/read 1.2 kHz filter calibration adjusted value (0000=0% to 0440=100%)

† Send/read data, 29 Command 29 supported

# 18 CONTROL COMMAND

## ◇ Command table (continued)

Cmd.	Sub Cmd.	Data	Description	
1A <sup>†</sup>	0A	see p. 18-13	Send/read limited TX output power level for the TX power limit function	
	0B	00 or 01	Send/read NTP server access (00=Stop, 01=Start)	
	0C	00 to 02	Read NTP server access result (00=Accessing, or has not been accessed after Power ON, 01=Succeeded, 02=Failed)	
1B <sup>†</sup>	00	see p. 18-13	Send/read repeater tone frequency	
	29	see p. 18-13	Set/read TSQL tone frequency	
1C <sup>†</sup>	00	00	Send/read transceiver's status (RX) *When "CI-V Output (for ANT)" (Command: 1C 04) is set to "ON," automatically outputs when changed.	
		01	Send/read transceiver's status (TX) *When "CI-V Output (for ANT)" (Command: 1C 04) is set to "ON," automatically outputs when changed.	
	01	00	Send/read the antenna tuner OFF (through)	
		01	Send/read the antenna tuner ON	
		02	Send/read to tuning	
	02	00	Send/read transmit frequency monitor setting OFF	
		01	Send/read transmit frequency monitor setting ON	
	03	see p. 18-11	Read transmit frequency *When "CI-V Output (for ANT)" (Command: 1C 04) is set to "ON," automatically outputs when changed.	
	04	00	Send/read command to disable to output the antenna controller status (frequency and so on) from [REMOTE]	
		01	Send/read command to enable to output the antenna controller status (frequency and so on) from [REMOTE]	
	1E	00		Read number of available TX frequency band
		01	see p. 18-13	Read TX band edge frequencies
		02		Read number of user-set TX frequency band
03		see p. 18-13	Send/read user-set TX band edge frequencies	
21	00	see p. 18-13	Send/read RIT frequency	
	01	00 or 01	Send/read RIT setting (00=OFF, 01=ON)	
	02	00 or 01	Send/read ΔTX setting (00=OFF, 01=ON)	
25		see p. 18-14	Send/read the Main or Sub band frequency	
26		see p. 18-14	Send/read the selected operating mode and filter	

Cmd.	Sub Cmd.	Data	Description
27	00	see p. 18-15	Read the Scope waveform data *Only when "Scope ON/OFF status" (Command: 27 10) and "Scope data output" (Command: 27 20) are set to "ON," outputs the waveform data to the controller.
		10	00 or 01
	11	00 or 01	Send/read the Scope data output (00=Output OFF, 01=Output ON) *Only when "CI-V USB Port" is set to "Unlink from [REMOTE]" and "CI-V USB Baud Rate" is set to 115200 (bps), "Output ON" is selectable.
	12	00 or 01	Send/read the Main or Sub scope setting (00=Main scope, 01=Sub scope)
	13	00 or 01	Send/read the Single/Dual scope setting (00=Single scope, 01=Dual scope)
	14	see p. 18-15	Send/read the Scope Center mode or Fixed mode setting
	15	see p. 18-15	Send/read the span setting in the Center mode Scope
	16	see p. 18-15	Send/read the Edge number setting in the Fixed mode Scope
	17	see p. 18-15	Send/read the Scope hold function ON or OFF
	18	see p. 18-16	Send/read the Scope Attenuator setting
	19	see p. 18-16	Send/read the Scope Reference level setting
	1A	see p. 18-16	Send/read the Sweep speed setting
	1B	00 or 01	Send/read the Scope indication during TX in the Center mode (00=OFF, 01=ON)
	1C	00 to 02	Send/read scope center frequency setting in the Center mode (00=Filter center, 01=Carrier point center, 02=Carrier point center (Abs. Freq.))
	1D	see p. 18-16	Send/read the Scope VBW setting
	1E	see p. 18-16	Send/read the Scope Fixed edge frequencies
	28	00	00 to 08
29 <sup>†</sup>		00/01 + Supported commands see p. 18-16	Regardless of active/inactive the Main or Sub band, you can directly specify the Main or Sub band, and send/read the supported command settings. (00=MAIN, 01=SUB)

<sup>†</sup> Send/read data, 29 Command 29 supported



◇ Data content description

• Operating frequency

Command: 00, 03, 05, 1C 03

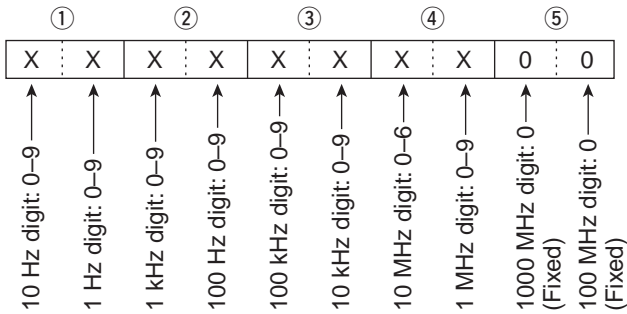

• Operating mode

Command: 01, 04, 06

Filter setting (2) can be skipped with command 01 and 06. In that case, "FIL1" is selected with command 01 and the default filter setting of the operating mode is selected with command 06, automatically.

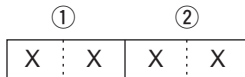

① Operating mode		② Filter setting
00: LSB	05: FM	01: FIL1
01: USB	07: CW-R	02: FIL2
02: AM	08: RTTY-R	03: FIL3
03: CW	12: PSK	
04: RTTY	13: PSK-R	

• Memory keyer content

Command: 1A 02

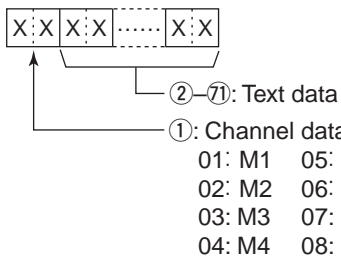

- Character codes

Character	ASCII code	Description
0-9	30-39	Numbers
A-Z	41-5A	Letters
space	20	Word space
/	2F	Symbol
?	3F	Symbol
,	2C	Symbol
.	2E	Symbol
@	40	Symbol
^	5E	e.g., to send BT, enter ^4254
*	2A	Inserts contest number (can be used for 1 channel only)

• Band stacking register

Command: 1A 01

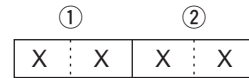

① Frequency band codes

Code	Freq. band	Frequency range (unit: MHz)
01	1.8	1.800000-1.999999
02	3.5	3.400000-4.099999
03	7	6.900000-7.499999
04	10	9.900000-10.499999
05	14	13.900000-14.499999
06	18	17.900000-18.499999
07	21	20.900000-21.499999
08	24	24.400000-25.099999
09	28	28.000000-29.999999
10	50	50.000000-54.000000
11	GENE	Other than above

② Register codes

Code	Registered number
01	1 (latest)
02	2
03	3 (oldest)

For example, when sending/reading the oldest contents in the 21 MHz band, the code "0703" is used.

When sending the contents, the following code should be added after code 2.

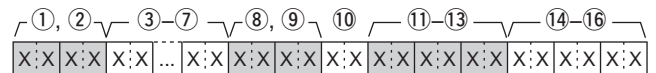

③-⑦ Operating frequency setting

See "• Operating frequency."

⑧, ⑨ Operating mode setting

See "• Operating mode."

⑩ Data mode and tone setting

1 byte data (XX)

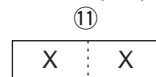

0: OFF, 1: TONE, 2: TSQL  
0: OFF, 1: DATA 1, 2: DATA 2, 3: DATA 3

⑪-⑬ Repeater tone frequency setting

⑭-⑯ Tone squelch frequency setting

See "• Repeater tone/tone squelch setting."

• Clock offset time settings

Command: 1A 050099, 050101

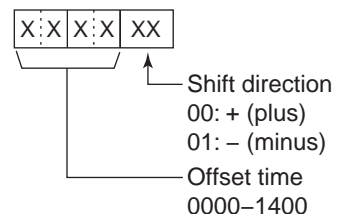

# 18 CONTROL COMMAND

◇ Data content description (continued)

## • Offset frequency settings

Command: 1A 050114, 050115, 050120

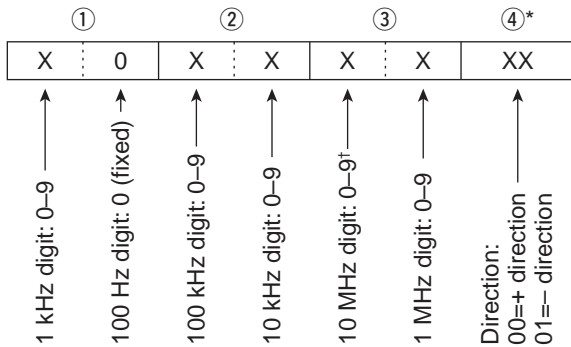

\*No need to enter for transverter offset frequency setting.  
†Transverter offset only, fix to '0' for split offset setting.

## • Color settings

Command: 1A 050189, 050190, 050191, 050257, 050266, 050267, 050268, 050269, 050274, 050279, 050280, 050281, 050282, 050289, 050291

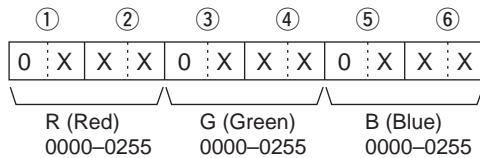

## • Bandscope edge frequency settings

Command: 1A 050198~050233

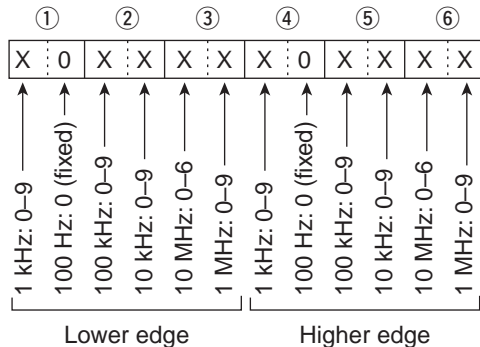

## • Data mode with filter width settings

Command: 1A 06

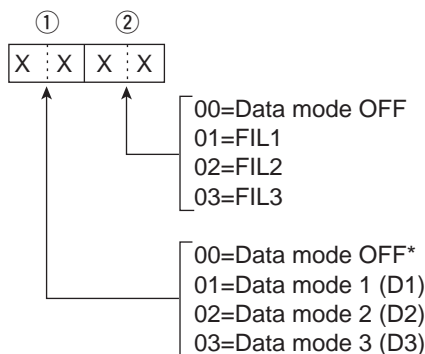

\* When "00" is set, set "00" in ②

## • Codes for the memory name, opening message, NTP server address, CLOCK2 name, network name, and network radio name contents

- Character codes— Letters

Character	ASCII code	Character	ASCII code
A-Z	41-5A	a-z	61-7A

- Character codes— Symbols

Character	ASCII code	Character	ASCII code
!	21	#	23
\$	24	%	25
&	26	\	5C
?	3F	"	22
'	27	`	60
^	5E	+	2B
-	2D	*	2A
/	2F	.	2E
,	2C	:	3A
;	3B	=	3D
<	3C	>	3E
(	28	)	29
[	5B	]	5D
{	7B	}	7D
	7C	_	5F
-	7E	@	40

Command	Set item/usable characters
1A 00	Memory name All characters are usable.
1A 050094	Opening message Upper case letters, numbers, some symbols (- / . @) and space are usable.
1A 050098	NTP server address Upper and lower case letters, numbers, and some symbols ( . _ ) are usable.
1A 050102	CLOCK2 name All characters are usable.
1A 05 0175	Network name Upper case letters, numbers, and some symbols (! # \$ % & " ^ + - . , ; = ( ) [ ] { } _ ` @) are usable.
1A 05 0181	Network radio name Upper and lower case letters, numbers, some symbols (! # \$ % & ? " ' ^ + - * / . , ; = < > ( ) [ ] { }   _ ` @) and space are usable.

## • RX HPF/LPF setting for each operating mode

Command: 1A 050001, 050004, 050007, 050010, 050011, 050012

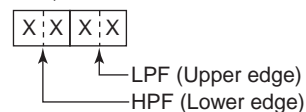

HPF	LPF
00: Through	05-24: 500~2400 Hz
01-20: 100~2000 Hz	25: Through

\*The value of the HPF should be smaller than the LPF.

• Repeater tone/tone squelch frequency settings

Command: 1B 00, 1B 01

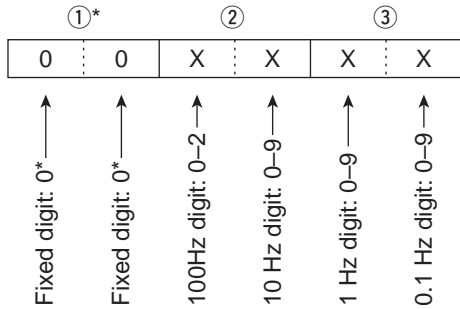

\*Not necessary when setting a frequency.

• SSB/SSB-D transmission passband width settings

Command: 1A 050019, 050020, 050021, 050320

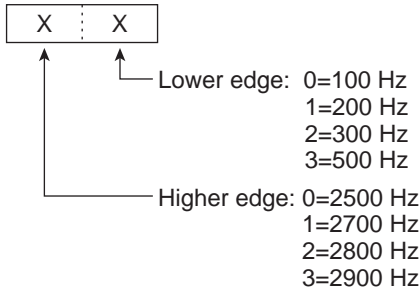

• Antenna memory settings

Command: 1A 050292~050303

Data	Antenna selection	
	for TX	for RX
00	ANT1	
01	ANT2	
02	ANT3	
03	ANT4	
04*	ANT1	ANT4
05*	ANT2	ANT4
06*	ANT3	ANT4

\*"RX" should be selected for ANT4.

• RIT frequency settings

Command: 21 00

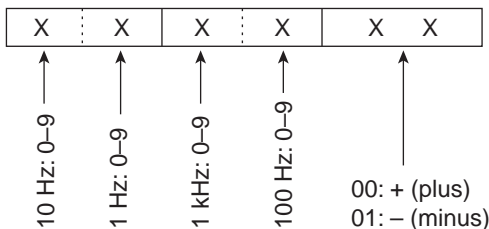

• Band edge frequency settings

Command: 02\*, 1E 01, 1E 03

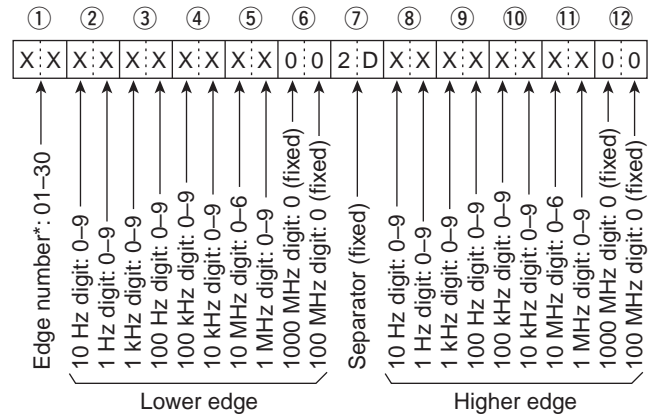

\*Edge number setting is not necessary with command 02.

• Codes for CW message contents

Command: 17 Up to 30 characters

To send CW messages, the following character codes are used.

Character	ASCII code	Character	ASCII code
0-9	30-39	'	27
A-Z	41-5A	(	28
a-z	61-7A	)	29
/	2F	=	3D
?	3F	+	2B
.	2E	"	22
-	2D	@	40
,	2C	Space	20
:	3A		

- "FF" stops sending CW messages.
- "A" is used to transmit a string of characters with no inter-character space.

• Transmit output power settings for transmit output power limiting

Command: 1A 0A

01: DATA OFF Output power limit  
02: DATA ON 0005: 5 W~0200: 200 W

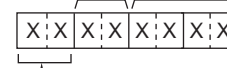

- Frequency band code
- 01: 1.8 MHz 07: 18 MHz
  - 02: 3.5 MHz 08: 21 MHz
  - 03: 5 MHz 09: 24 MHz
  - 04: 7 MHz 10: 28 MHz
  - 05: 10 MHz 11: 50 MHz
  - 06: 14 MHz

# 18 CONTROL COMMAND

◇ Data content description (continued)

## • Memory content setting

Command: 1A 00

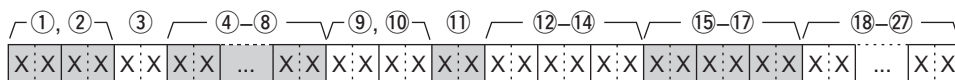

### ①, ② Memory channel numbers

- 0001-0099: Memory channel 1 to 99
- 0100: Programmed scan edge P1
- 0101: Programmed scan edge P2

/// To clear the memory channel contents, add the code "FF" after the memory channel number. (instead of the data ③ to ㉑)  
 /// This completes the memory clearing.

### ③ Select memory setting

- 00: OFF
- 01: ★1
- 02: ★2
- 03: ★3

### ④~⑧ Operating frequency setting

See "• Operating frequency."

### ⑨, ⑩ Operating mode setting

See "• Operating mode."

## • Main or Sub band's frequency settings

Command : 25

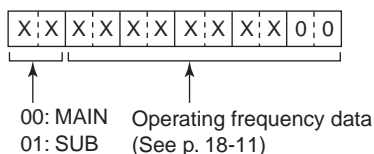

## • Main or Sub band's operating mode and filter settings

Command : 26

Both data and filter settings can be skipped. In that case, "DATA OFF" and the default filter setting of the operating mode is automatically selected.

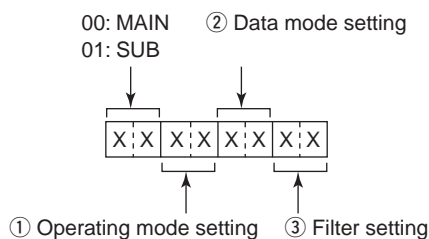

① Operating mode		② Data mode		③ Filter	
00: LSB	05: FM	00: Data mode OFF		01: FIL1	
01: USB	07: CW-R	01: Data mode 1 (D1)		02: FIL2	
02: AM	08: RTTY-R	02: Data mode 2 (D2)		03: FIL3	
03: CW	12: PSK	03: Data mode 3 (D3)			
04: RTTY	13: PSK-R				

### ⑪ Data mode and tone type settings

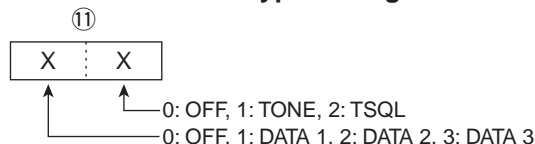

### ⑫~⑭ Repeater tone frequency setting

### ⑮~⑰ Tone squelch frequency setting

See "• Repeater tone/tone squelch settings."

### ⑱~㉑ Memory name settings

Up to 10 characters.

See "• Codes for the memory name, opening message, NTP server address, CLOCK2 name, network name, and network radio name contents."

• **Scope waveform data**

Command: 27 00

Outputs the waveform data to the controller

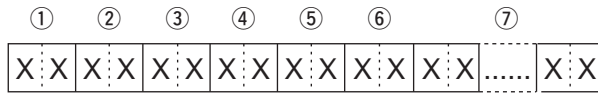

① Main or Sub scope data  
 • 00=Main scope, 01=Sub scope

② Order of division data (Current)

③ Division number (01 or 15)

When data is sent to the controller through the LAN port, all data is sent together. However, when the data is sent through the USB port, the data is divided by 15 and sent in sequential order.

	Division number	Data length	
LAN	1	704	
USB	15	1st data	15
		2nd or later data	53
		15th data	42

The 1st data sends only the wave information (① ~ ⑥) without the waveform data (⑦).

The 2nd or later data sends the minimum wave information (① ~ ③) with waveform data (⑦).

④ Center or Fixed mode data  
 • 00 = Center mode scope, 01 = Fixed mode scope

⑤ Waveform information

The waveform information is different between Center mode and fixed mode.

• In the Center mode: Center frequency and span are sent

See page 18-11 for Frequency data, and the Scope span settings to the right.

• In the Fixed mode: Lower edge and higher edge frequencies are sent

See page 18-16 for Scope Fixed edge frequency settings ③ ~ ⑫.

⑥ Out of range information  
 • 00 = In range, 01 = Out of range

If the scope data is out of range, the waveform data (⑦) is omitted.

⑦ Waveform data

The transceiver outputs the drawn waveform data. The data range or data length of the waveform data is judged by the controller. (The data range is basically the same as the display size of the scope on the controller.)

Data range	0 ~ 136
Data length	689

• **Center/Fixed mode settings**

Command: 27 14

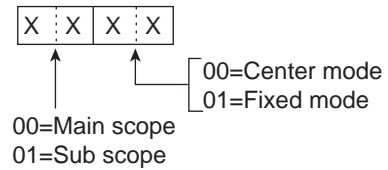

• **Scope span settings**

Command: 27 15

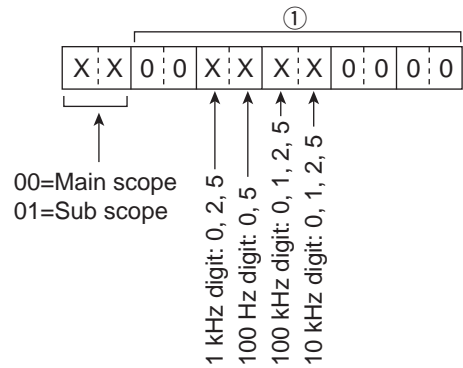

① Selectable Span

Span (Hz)	
2500	2.5 k
5000	5 k
10000	10 k
25000	25 k
50000	50 k
100000	100 k
250000	250 k
500000	500 k

• **Scope Edge number settings**

Command: 27 16

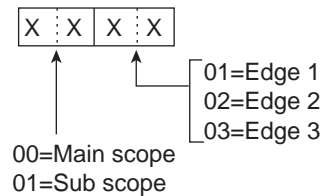

• **Scope Hold settings**

Command: 27 17

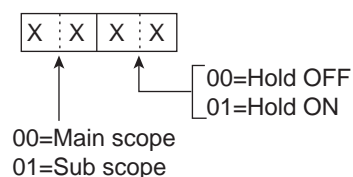

# 18 PANEL DESCRIPTION

◇ Data content description (continued)

## • Scope Attenuator settings

Command: 27 18

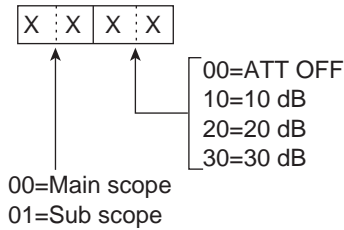

## • Scope Reference level settings

Command: 27 19

Common settings for the Main and Sub scopes

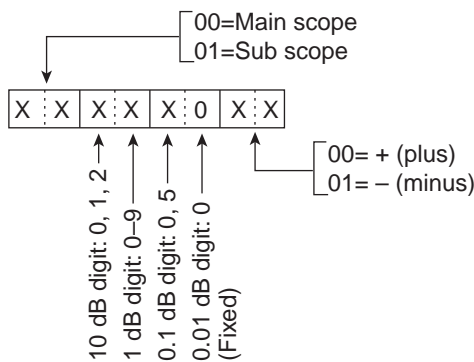

• Adjustable range: -20.0 dB ~ +20.0 dB in 0.5 dB steps

## • Scope Sweep speed settings

Command: 27 1A

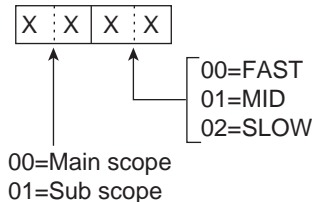

## • Scope VBW (Video Band Width) settings

Command: 27 1D

Common settings for the Main and Sub scopes

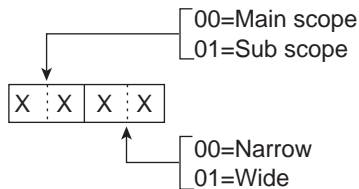

## • Scope Fixed edge frequency settings

Command: 27 1E

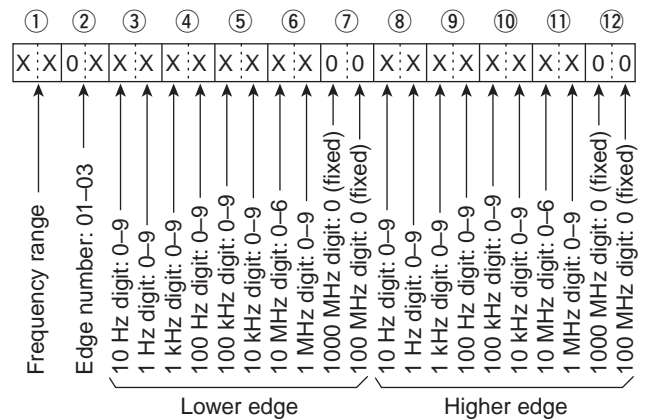

• Entry of 100 Hz or smaller digits are ignored.

### ① Selectable Frequency ranges

Data	Frequency range	Data	Frequency range
01	0.03 – 1.60 MHz	07	15.00 – 20.00 MHz
02	1.60 – 2.00 MHz	08	20.00 – 22.00 MHz
03	2.00 – 6.00 MHz	09	22.00 – 26.00 MHz
04	6.00 – 8.00 MHz	10	26.00 – 30.00 MHz
05	8.00 – 11.00 MHz	11	30.00 – 45.00 MHz
06	11.00 – 15.00 MHz	12	45.00 – 60.00 MHz

② Selectable Edge number: 01 = 1, 02 = 2, 03 = 3

## • Setting after directly specify the Main/Sub band

Command : 29

Specify the Main or Sub band before entering the supported commands.

When you receive the OK code (FB), or the NG code (FA), the Command 29 and Main/Sub specify (00/01) is omitted.

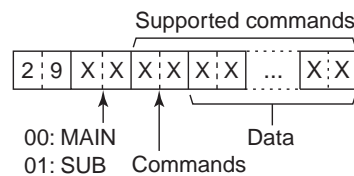

The supported commands are marked by '29' in the command table.



- Specifications ..... 19-2
  - ◇ General ..... 19-2
  - ◇ Transmitter ..... 19-2
  - ◇ Receiver ..... 19-3
  - ◇ Antenna tuner..... 19-3
- Options ..... 19-4

## ■ Specifications

### ◇ General

- **Frequency coverage** (unit: MHz):
 

Receiver	0.030000–60.000000*1
Transmitter	0.135700–0.137800*2, 1.800000–1.999999*2, 3.500000–3.999999*2, 5.255000 – 5.405000*1, *2, 7.000000–7.300000*2, 10.100000–10.150000*2, 14.000000–14.350000*2, 18.068000–18.168000*2, 21.000000–21.450000*2, 24.890000–24.990000*2, 28.000000–29.700000*2, 50.000000–54.000000*2
- **Operating mode:**
  - \*1Some frequency ranges are not guaranteed.
  - \*2Depending on versions.
  - USB/LSB (J3E), CW (A1A), RTTY (F1B),  
PSK31/63 (G1B), AM (A3E), FM (F3E)
- **Number of memory channels:** 101 (99 regular, 2 scan edges)
- **Antenna connectors:** SO-239×4 (antenna impedance: 50 Ω)
- **Operating temperature range:** 0°C to +50°C, +32°F to +122°F
- **Frequency stability:** Less than ±0.05 ppm (approximately 5 minutes after from turn the main power, [I/O], ON, 0–50°C; 32–122°F, 54.000000 MHz)
- **Frequency resolution:** 1 Hz (minimum)
- **Power supply requirement:** 85–265 V AC (universal input)
- **Power consumption:**

Power OFF Standby	15 VA typical (at 100 V AC)
Remote Standby	20 VA typical (at 100 V AC)
Receive Standby	150 VA typical
Transmit Maximum audio at 200 W	150 VA typical 800 VA
- **Dimensions** (projections not included): 425 (W)×149 (H)×435 (D) mm, 16.7 (W)×5.9 (H)×17.1 (D) in
- **Weight:** Approximately 23.5 kg; 52 lb
- **ACC 1 connectors:** 8-pin DIN connector×2
- **ACC 2 connectors:** 7-pin DIN connector×2
- **EXT-DISPLAY connector:** DVI-I
- **CI-V connector:** 2-conductor 3.5 (d) mm (1/8")
- **KEYBOARD connector:** USB

### ◇ Transmitter

- **Transmit output power:**

SSB, CW, RTTY, PSK, FM	Less than 5–200 W
AM	Less than 5–50 W
137 kHz band	More than –20 dBm (Europe version only)
- **Modulation system:**

SSB	P.S.N. modulation
AM	Low power modulation
FM	Phase modulation
- **Spurious emission:**

Harmonics	More than 60 dB (HF bands) More than 70 dB (50 MHz band)
Spurious (except harmonics)	More than 50 dB (HF bands) More than 70 dB (50 MHz band)
Out of band emission	More than 40 dB (HF bands) More than 60 dB (50 MHz band)
- **Carrier suppression:** More than 63 dB
- **Unwanted side-band suppression:** More than 70 dB
- **ΔTX variable range:** ±9.999 kHz
- **Microphone connector:** 8-pin connector (600 Ω)
- **ELEC-KEY connector:** 3-conductor 6.35 (d) mm (1/4")
- **KEY connector:** 3-conductor 6.35 (d) mm (1/4")
- **RELAY connector:** Phono (RCA)
- **ALC connector:** Phono (RCA)

All stated specifications are typical and subject to change without notice or obligation.

■ **Specifications (Continued)**

◇ **Receiver**

- **Receive system:** Double conversion superheterodyne system
- **Intermediate frequencies:**
  - 1st 64.455 MHz (Main band)  
64.555 MHz (Sub band)
  - 2nd 36 kHz
- **Sensitivity for all versions:**
  - SSB, CW, RTTY, PSK (BW=2.4 kHz, 10 dB S/N, Typical)
    - 0.100– 1.799999 MHz 0.5 µV (pre-amp 1 ON)
    - 1.800– 29.999999 MHz 0.16 µV (pre-amp 1 ON)
    - 50.000– 54.000000 MHz 0.13 µV (pre-amp 2 ON)
  - AM (BW=6 kHz, 10 dB S/N, Typical)
    - 0.100– 1.799999 MHz 6.3 µV (pre-amp 1 ON)
    - 1.800– 29.999999 MHz 2 µV (pre-amp 1 ON)
    - 50.000– 54.000000 MHz 1 µV (pre-amp 2 ON)
  - FM (BW=15 kHz, 12 dB SINAD, Typical)
    - 28.000– 29.700000 MHz 0.5 µV (pre-amp 1 ON)
    - 50.000– 54.000000 MHz 0.32 µV (pre-amp 2 ON)
- **Sensitivity for the IC-7851 European versions:**
  - SSB (BW=2.4 kHz, 12 dB SINAD)
    - 1.800– 2.999999 MHz Less than 10 dBµV emf (pre-amp 1 ON)
    - 3.000– 29.999999 MHz Less than 0 dBµV emf (pre-amp 1 ON)
    - 50 MHz band Less than –6 dBµV emf (pre-amp 2 ON)
  - AM (BW=4 kHz, 60% modulation, 12 dB SINAD)
    - 1.800– 2.999999 MHz Less than 16 dBµV emf (pre-amp 1 ON)
    - 3.000– 29.999999 MHz Less than 6 dBµV emf (pre-amp 1 ON)
    - 50 MHz band Less than 0 dBµV emf (pre-amp 2 ON)
  - FM (BW=7 kHz, 60% modulation, 12 dB SINAD)
    - 28.000– 29.700000 MHz Less than 0 dBµV emf (pre-amp 1 ON)
    - 50.000– 54.000000 MHz Less than –6 dBµV emf (pre-amp 2 ON)
- **Selectivity (with optimum roofing filter):**
  - SSB, RTTY (BW=2.4 kHz)
    - More than 2.4 kHz/–3 dB
    - Less than 3.6 kHz/–60 dB
  - CW/RTTY/PSK (BW=500 Hz)
    - More than 500 Hz/–3 dB
    - Less than 700 Hz/–60 dB
  - AM (BW=6 kHz)
    - More than 6.0 kHz/–3 dB
    - Less than 15.0 kHz/–60 dB
  - FM (BW=15 kHz)
    - More than 12.0 kHz/–6 dB
    - Less than 20.0 kHz/–60 dB
- **Spurious and image rejection ratio:** More than 70 dB
- **Squelch sensitivity (pre-amp OFF):**
  - SSB, CW, RTTY, PSK31/63 Less than 5.6 µV
  - FM Less than 1 µV
- **RIT variable range:** ±9.999 kHz
- **Audio output power:** More than 2.6 W at 10% distortion with an 8 Ω load
- **PHONES connector:** 3-conductor 6.35 (d) mm (1/4")
- **EXT-SP connectors:** 2-conductor 3.5 (d) mm (1/8")/8 Ω×2 (for Main and Sub)

◇ **Antenna tuner**

- **Matching impedance range:** 16.7 to 150 Ω unbalanced (HF bands; VSWR better than 3:1)  
20 to 125 Ω unbalanced (50 MHz band; VSWR better than 2.5:1)
- **Minimum operating input:** 8 W (HF bands)  
15 W (50 MHz band)
- **Tuning accuracy:** VSWR 1.5:1 or less
- **Insertion loss (after tuning) :** Less than 1.0 dB

## Options

### IC-PW1/EURO HF/50 MHz ALL BAND 1 kW LINEAR AMPLIFIER



Full-duty-cycle 1 kW linear amplifier including an automatic antenna tuner. Has automatic tuning and band selection capability when used with an Icom transceiver. Full break-in (QSK) operation. The amplifier/power supply unit and the remote control unit are separate.

### SP-34 EXTERNAL SPEAKER



4 audio filters, headphone jack, can be connected to 2 transceivers.  
 • Input impedance: 8 Ω  
 • Max. input power: 5 W

### SM-50 DESKTOP MICROPHONE



Unidirectional, dynamic microphone for base station operation. Includes [UP]/[DOWN] switches, a low cut switch and mic gain control.

### SM-30 DESKTOP MICROPHONE



Unidirectional, electret microphone for base station operation. Includes a low cut switch and mic gain control.

### CT-17 CI-V LEVEL CONVERTER



For remote transceiver control using a PC. You can change frequencies, operating mode, memory channels, etc. (software is not included)

### HM-36 HAND MICROPHONE



Hand microphone equipped with [UP]/[DOWN] switches.

### RC-28 REMOTE ENCODER



For operating the RS-BA1 (version 1.3 or later) or using as a remote control dial to operate the transceiver.

### SP-33 EXTERNAL SPEAKER

Designed for base station operation.  
 • Input impedance: 8 Ω  
 • Maximum input power: 5 W

### RS-BA1 IP REMOTE CONTROL SOFTWARE

☐ To remotely control radios using the RS-BA1, **BE SURE** that you comply with your local regulations.

\*The LCD display may have cosmetic imperfections that appear as small or dark spots. This is not a malfunction or defect, but a normal characteristic of LCD displays.

Spurious signals may be received near the following frequencies. These are made in the internal circuit and does not indicate a transceiver malfunction.

- 0.150 MHz, 1.049 MHz, 19.660 MHz and 24.576 MHz

Spurious waveforms may be displayed on the Spectrum scope screen regardless of the transceiver's condition (Tx or Rx). They are made in the scope circuit. This does not indicate a transceiver malfunction.

---

- ACC socket ..... 20-2
- Microphone connector ..... 20-3
- [ELEC-KEY] jack ..... 20-3
- [KEY] jack ..... 20-3
- [EXT KEYPAD] jack ..... 20-4
- [REF I/O] connector ..... 20-4
- [X-VERTER] connector ..... 20-4
- [RELAY] jack ..... 20-4
- [METER] jack ..... 20-5
- [REMOTE] jack ..... 20-5
- [DC OUT] jack..... 20-5
- [EXT-SP] jack ..... 20-5
- [S/P DIF] jack ..... 20-5
- [RX-I/O] connector ..... 20-5

## ■ ACC socket

Connects to external equipment or a personal computer to control the external unit or to control the transceiver.

Sockets [A ACC1] and [A ACC2] output AF signals of the Main band, sockets [B ACC1] and [B ACC2] output AF signals of the Sub band.

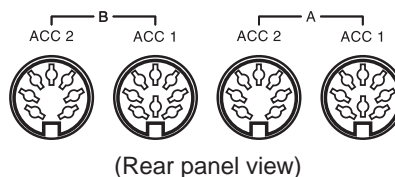

ACC 1	PIN No.	NAME	DESCRIPTION	SPECIFICATIONS	
 (Rear panel view)	1	RTTY	Controls RTTY keying	"High level": More than 2.4 V "Low level": Less than 0.6 V Output current: Less than 2 mA	
	2	GND	Connects to ground.	Connected in parallel with ACC 2 pin 2.	
	3	SEND*	Input/output pin. Connected in parallel with ACC 2 pin 3.	An external equipment controls the transceiver. When this pin goes low, the transceiver transmits. The pin outputs a low level signal when the transceiver transmits.	Input voltage (TX): -0.5 V to 0.8 V Input voltage (RX): 2.0 V to 20.0 V Current flow: Maximum 20 mA
	4	MOD	Modulator input. Connects to the internal modulator circuit.	Input impedance: 10 kΩ Output level: Approximately 100 mV rms	
	5	AF/ IF (IF=12 kHz)	Fixed AF detector or receive IF (12 kHz) signal output.	Output impedance: 4.7 kΩ Output level: 100–300 mV rms	
	6	SQLS	Squelch output. Grounded when the squelch opens.	SQL open: Less than 0.3 V/5 mA SQL closed: More than 6.0 V/100 μA	
	7	15V	15V output when power is ON. Connected in parallel with ACC 2 pin 7.	Output current: Max. 1 A	
	8	ALC	ALC voltage input. Connected in parallel with ACC 2 pin 5.	Input impedance: More than 10 kΩ Input level: -4 V to 0 V	

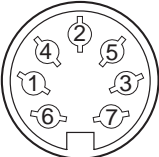
ACC 2	PIN No.	NAME	DESCRIPTION	SPECIFICATIONS
 (Rear panel view)	1	8 V	Regulated 8 V output.	Output voltage: 8 V ±0.3 V Output current: Less than 10 mA
	2	GND	Same as ACC 1 pin 2.	
	3	SEND*	Same as ACC 1 pin 3.	
	4	BAND	Band voltage output. (Varies with the selected amateur band)	Output voltage: 0 V to 8.0 V
	5	ALC	Same as ACC 1 pin 8.	
	6	TRV	Activates [X-VERTER] input/output when "HIGH" voltage is applied	Input impedance: More than 10 kΩ Input voltage: 2 V to 13.8 V
	7	15V	Same as ACC 1 pin 7.	



## Microphone connector

(Front panel view)

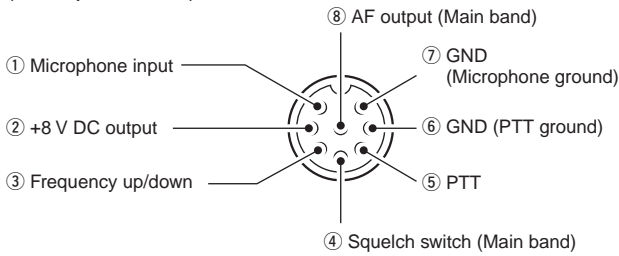

PIN No.	DESCRIPTION
①	Microphone input (Impedance: 600 Ω)
②	+8 V DC output (Max. 10 mA)
③	Up: Ground Down: Ground through 470 Ω
④	"Low" level when the squelch opens.
⑤	PTT
⑥	PTT ground
⑦	Microphone ground
⑧	AF output (varies with [AF])

8 V DC is applied to pin 1 for microphone operation. You can turned OFF if it is not necessary in the "MIC Input DC Bias" item of the Others set screen. (p. 15-16)

The circuit is used to output memory information in 4-channel memories. You can output desired memory information such as that from a CW Memory keyer, Voice memory, RTTY/PSK Memory to be transmitted. Push a switch to send the memory information. Hold down the switch for one second to repeatedly send the memory information.

When you connect the external keypad, turn ON the following items in the Other set screen. (p. 15-16) (SET [F-7] > OTHERS[F-5])

- External Keypad (Voice)
- External Keypad (Keyer)
- External Keypad (RTTY)
- External Keypad (PSK)

**NOTE:** You cannot transmit the CW memory keyer and Voice memory from T5 to T8, the RTTY memory from RT5 to RT8, or the PSK memory from PT5 to PT8.

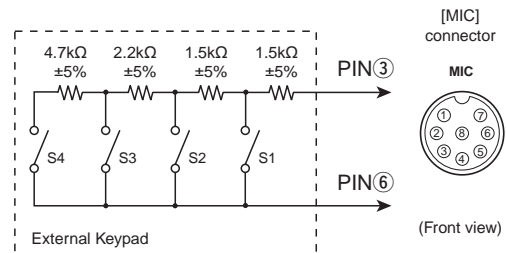

## [ELEC-KEY] jack

Connect to a CW paddle. You can change the paddle activation in the "Keyer Type" item of the Keyer CW-Key screen. ([KEYER [F-3]] > [EXIT/SET] > CW KEY [F-4] > Keyer Type)

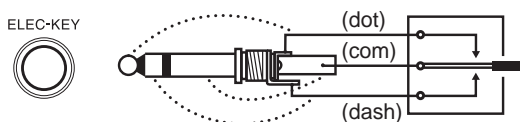

## [KEY] jack

Connect to a CW straight key or the output of an external electronic keyer.

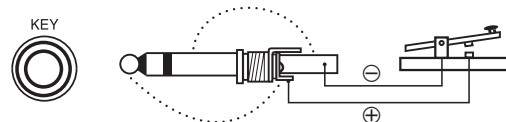

## ■ [EXT KEYPAD] jack

The circuit is used to output memory content in 8 channel memories. You can output desired memory content such as CW Memory keyer, Voice memory, RTTY/PSK Memory to be transmitted. Push a switch to send the memory information. Hold down the switch for 1 second to repeatedly send the memory information.

When you connect the external keypad, turn ON the following items in the Others set screen. (p. 15-16)  
(SET [F-7] > OTHERS[F-5])

- External Keypad (Voice)
- External Keypad (Keyer)
- External Keypad (RTTY)
- External Keypad (PSK)

Mute switch: Mutes both transmission and reception when the switch is turned ON.

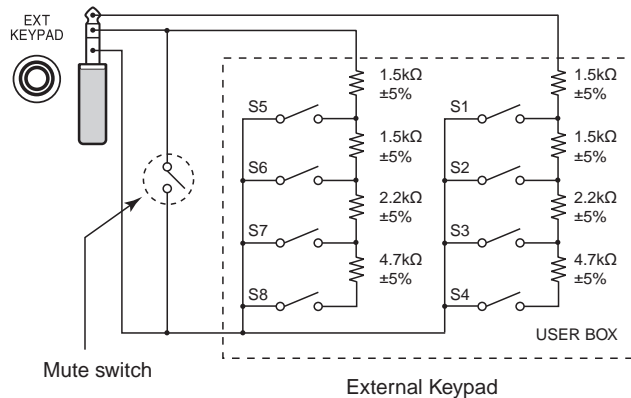

## ■ [REF I/O] connector

This connector outputs or inputs a 10 MHz reference signal.

- Input/Output impedance: 50 Ω
- Output level: Approximately -10 dBm
- Required input level: Approximately -10 dBm
- Output signal stability: ±0.05 ppm (0 ~ +50°C)

If you use an external reference signal, set to "IN" in the "REF IN/OUT" item of the ACC set screen.



You can adjust the internal Reference Signal frequency in the "REF Adjust" item of the ACC set screen.  
(SET [F-7] > ACC [F-2] > REF Adjust)

## ■ [X-VERTER] connector

You can connect your transverter unit through the connector.



- Input/output impedance: 50 Ω
- Output level: Approximately -20 dBm or more

You can change the transverter function in the "Transverter Function" item of the Others set screen.

You can also adjust the offset frequency in the "Transverter Offset" item of the Others set screen.  
(SET [F-7] > OTHERS [F-5] > Transverter Offset)

## ■ [RELAY] jack

Goes to ground when transmitting to control an external non-Icom linear amplifier. You can select either mechanical relay or semi-conductor MOS-FET control.



Specifications

- Mechanical relay (Reed Relay): 16 V DC/Less than 0.5 A
- MOS-FET: Less than 250 V/ Less than 250 mA

You can change the control in the "SEND Relay Type" item of the ACC set screen.  
(SET [F-7] > ACC [F-2] > SEND Relay Type)

When the SEND terminal controls the inductive load (such as a relay), a counter-electromotive force can cause the transceiver's malfunction or damage. To prevent this, we recommend adding a switching diode, such as an "1SS133," on the load side of the circuit to the counter-electromotive force.

[Example]

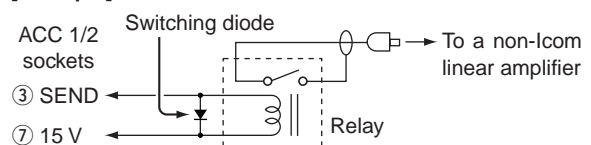

### ■ [METER] jack

Connects to an external meter.

- Output impedance: 4.7 kΩ
- Output voltage can be adjusted to 5 V maximum

You can adjust the output voltage with the “External Meter Level (M)” for the Main band and “External meter Level (S)” item for the Sub band in the ACC set mode.

(SET [F-7] > ACC [F-2])

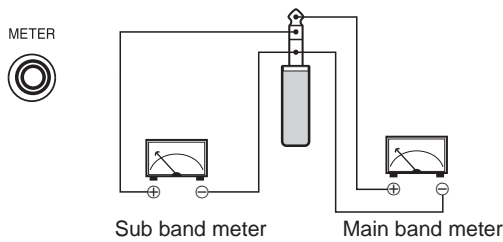

### ■ [EXT-SP] jack

Connects an external speaker.

- Output impedance: 4 ~ 8 Ω
- Output level: More than 2.6 W at 10% distortion with an 8 Ω load.

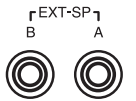

### ■ [S/P DIF] jack

Inputs/Outputs digital audio signal through an optic fiber cable for transmit modulation or AF output.

- Sampling rate: 48 kHz/24 bit (Stereo output)
- L side: Output of the Main band
- R side: Output of the Sub band



### ■ [REMOTE] jack

Used for computer control and transceive operation. The optional CT-17 is required when connecting a PC to [REMOTE].

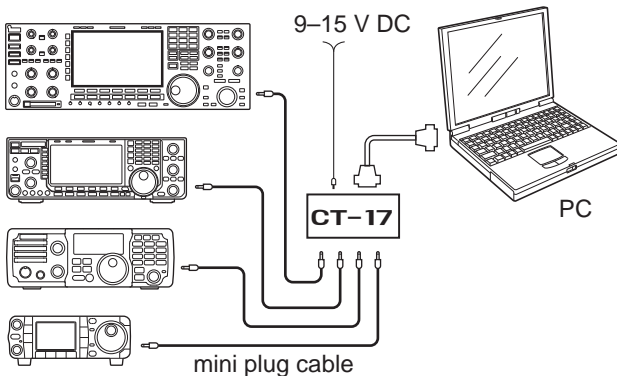

### ■ [RX-I/O] connector

Connects an external preamp or low pass filter etc. for your operation needs. RX ANT IN/OUT must be activated in the ANT screen.

[Example]

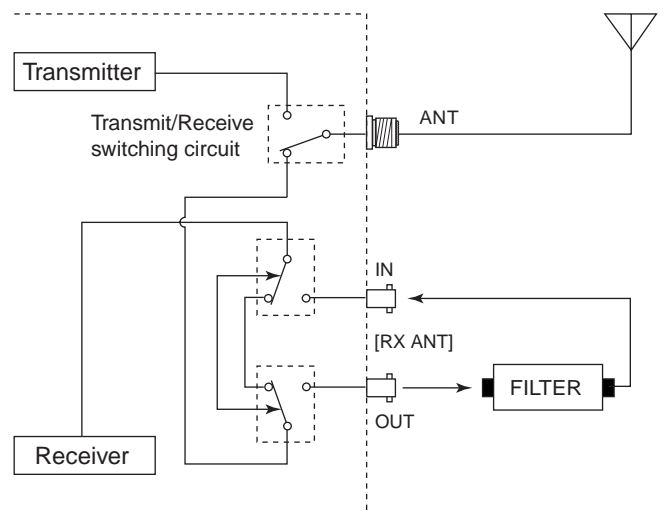

### ■ [DC OUT] jack

Outputs regulated 15 V DC.

- Output voltage: Approximately 15 V with no load  
Approximately 14 V with a load
- Current capacity: Maximum 1 A

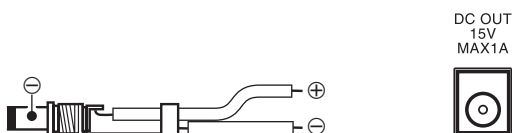

# INDEX

Symbol	Number
$\Delta$ F scan .....	12-9
$\Delta$ TX function.....	8-5
Monitor function.....	8-5
<b>A</b>	
ABOUT THE SUPPLIED CD .....	iv
About the VOX function .....	8-2
ACC set screen .....	2-8, 15-6
ACC socket.....	20-2
ACC1 .....	20-2
ACC2 .....	20-2
Advanced connections .....	3-5
AFC/NET function.....	5-28
AGC	
AGC function control .....	7-4
AGC time constant .....	7-4
Setting the AGC time constant preset value.....	7-4
AM mode	
Operating AM or FM.....	5-36
Antenna connection and selection.....	13-2
Antenna Memory .....	10-4
Antenna memory settings.....	13-3
Antenna selection mode .....	13-5
Antenna tuner .....	13-7, 19-3
Using the Antenna tuner operation.....	13-7
If the tuner cannot tune the antenna .....	13-8
Antenna type .....	2-16, 13-4
Selecting the antenna type.....	13-4
APF (Audio Peak Filter) operation .....	5-6
Attenuator .....	7-2
Audio scope screen .....	6-15
AUDIO SCOPE SET.....	2-6
Audio scope set mode .....	6-16
FFT Scope	
FFT Scope Waterfall Display .....	6-16
FFT Scope Waveform Color .....	6-16
FFT Scope Waveform Type .....	6-16
Oscilloscope	
Oscilloscope Waveform Color.....	6-16
Audio level .....	4-4
Automatic transmission/reception setting ....	5-18, 5-30
Auto notch function.....	7-13
Auto tuning step function .....	4-8
Averaging.....	6-10
<b>B</b>	
Band edge warning beep.....	4-15
Entering the user band edge .....	4-16
Register the Band edge.....	4-16
User band edge.....	4-15
Band stacking registers .....	4-6
Band selection	
Selecting the Main and Sub bands.....	4-5
BPSK and QPSK modes .....	5-27
BPSK31 and BPSK63 modes.....	5-27
Break-in function.....	8-4
Full break-in operation.....	8-4
Semi break-in operation .....	8-4
<b>C</b>	
Calibration the Frequency (approximate) .....	16-4
Capture list screen.....	10-10
Checking the firmware version .....	17-2
Checking the repeater input signal .....	5-37
CI-V	
CI-V Address .....	10-4
CI-V connection .....	18-2
Command table .....	18-3
Data content description.....	18-10
Data format.....	18-2
Preparing.....	18-2
Cleaning .....	16-7
Clock	
Entering the CLOCK2 Name .....	14-3
Selecting the CLOCK2 Function .....	14-3
Setting the CLOCK2 UTC Offset.....	14-3
Setting the Current time .....	14-2
Setting the Date.....	14-2
Clock backup battery replacement .....	16-9
Confirming programmed memory channels .....	11-3
Connecting a non-Icom linear amplifier .....	3-7
Connecting antenna .....	3-3
Connecting the IC-PW1/EURO .....	3-7
Connections	
Advanced connections .....	3-5
Required connections.....	3-4
Connector	
Microphone connector.....	20-3
[REF I/O] connector.....	20-4
[RX-I/O] connector.....	20-5
[X-VERTER] connector.....	20-4
Contest number set mode .....	5-12
Convenient functions for Receive .....	5-2
Convenient functions for Transmit.....	5-3



## INDEX

### L

- Level set screen.....2-7, 15-4
- Linear amplifier connections.....3-7
- Loading the saved data files
  - Onto an SD card.....10-6
  - Onto a USB flash drive.....10-6
- Load set screen .....2-16, 10-4
  - Antenna Memory .....10-4
  - Load Contents .....10-4
  - Other Memory & Settings.....10-4
  - REF IN/OUT, REF Adjust, Filter CAL .....10-4
- Location selecting.....3-2

### M

- Main dial
  - Main dial attachment .....3-3
  - Main dial brake .....16-2
- Main/Sub band tracking function .....7-14
- Manual notch function .....7-13
- Marker Position (Fixed Type) .....6-10
- Max Hold .....6-10
- Memo pads.....11-7
  - Calling up a frequency and operating mode....11-8
  - Entering frequencies and operating modes....11-7
  - Temporary memory .....13-5
  - Using the Memo pad list screen .....11-8
- Memory channels .....11-2
  - Copying Memory contents.....11-5
    - Copying in the Memory mode .....11-5
    - Copying in the VFO mode .....11-5
  - Entering Memory channel contents.....11-4
    - Entering in the Memory mode .....11-4
    - Entering in the VFO mode .....11-4
  - Memory channel selection.....11-2
  - Memory clearing.....11-6
  - Selecting a memory channel
    - Using the M-CH [▲] or [▼] keys .....11-2
    - Using the Memory list screen .....11-3
- Memory keyer screen .....5-10
- Memory list screen .....11-3
- Memory mode selection .....4-5
- Memory name .....11-6
  - Editing (programming) memory names .....11-6
- Memory scan.....12-7
- Memory & Settings .....10-4
- Meter
  - [METER] jack.....20-5
  - Selecting the Meter readout .....4-11
  - Selecting the meter type.....4-12
- Microphone connector .....20-3
- Microphone gain.....4-13

- Microphones (optional products) .....3-9
- Mini scope screen.....6-6
- Monitor function .....8-5
- My call sign.....16-5

### N

- NB Set mode .....2-17, 7-11
  - NB Depth.....7-11
  - NB Width .....7-11
- Network Settings .....10-4
- Noise blanker.....7-11
- Noise reduction.....7-12
- Noise squelch .....4-4
- Notch function.....7-13
  - Auto notch function.....7-13
  - Manual notch function .....7-13
- NTP Function.....14-4
  - Setting the NTP Server address.....14-4

### O

- Opening the transceiver's case .....16-8
- Operating band selection.....4-6
- Operating mode selection.....4-10
- Optimum Roofing Filter.....7-8
- Options .....19-4
- Other Memory & Settings .....10-4
- Others set screen .....2-11, 15-13

### P

- Pause while playing .....9-5
- PBT (Passband Tuning) function .....7-5
- Playing back .....9-9
- Playing back the recorded audio .....9-8
- Playing back the recorded audio (QSO).....9-4
- Playing the next file.....9-5
- Playing the previous file.....9-5
- Play Time .....9-14
- Power ON .....4-3
  - When first applying power .....4-2
- Preamplifier .....7-2
- PRECAUTIONS.....iii
- PRE-REC for PTT Auto REC.....9-14
- Programmed scan .....12-5
- Programming a record name.....9-10
- Protection indications .....16-8
- PSK log
  - Confirm the PSK log contents .....5-33
  - Turning ON the PSK log .....5-32
- PSK mode



- BPSK and QPSK modes ..... 5-27  
 BPSK31 and BPSK63 modes ..... 5-27  
 Operating..... 5-24  
 PSK DECODE SET ..... 2-6  
 PSK decode set mode..... 5-34  
 PSK LOG SET..... 2-6  
 PSK memory transmission ..... 5-29  
 PSK reverse mode ..... 5-28  
 Setting the PSK decoder threshold level ..... 5-28  
 PSK memory  
   Editing the PSK memory ..... 5-31  
 PTT Auto REC..... 9-14
- Q**
- QPSK mode..... 5-27  
 QSO PLAY Skip Time ..... 9-14  
 QSO REC ..... 9-2  
   Basic recording..... 9-3  
   Deleting a recorded audio file..... 9-6  
   Deleting a recorded audio folder ..... 9-6  
   QSO REC Storage Media ..... 9-13  
   Quick recording ..... 9-3  
   Playing back  
     Fast forward while playing ..... 9-5  
     Moving to the beginning of the next file ..... 9-5  
     Moving to the beginning of the previous file ..... 9-5  
     Operating while playing back..... 9-5  
     Pause while playing ..... 9-5  
     Playing back the recorded audio (QSO) ..... 9-4  
     Playing the next file ..... 9-5  
     Playing the previous file..... 9-5  
     Rewind while playing ..... 9-5  
   Recording contents ..... 9-2  
 Quick Dualwatch function ..... 7-10  
 Quick split function ..... 8-8  
 Quick tuning step..... 4-7
- R**
- Rack mounting handle ..... 3-2  
 RC-28 ..... 3-10  
 Rear panel ..... 1-12  
   Basic connection ..... 3-4  
   External keypad and meter..... 3-6  
   Optional products and external equipment..... 3-5  
 Receive antenna I/O setting ..... 13-6  
 Receiver ..... 19-3  
 Rec Mode ..... 9-13  
 Recording function..... 9-2  
 REF IN/OUT, REF Adjust, Filter CAL ..... 10-4  
 [REF I/O] connector..... 20-4  
 Reference level..... 6-8
- [RELAY] jack..... 20-4  
 Remote control (CI-V) information..... 18-2  
 [REMOTE] jack ..... 20-5  
 Removing the SD card ..... 10-2  
 Repeater operation ..... 5-37  
   Repeater tone frequency setting ..... 5-38  
 Repeat Time ..... 9-13  
 Repeat TX..... 9-11  
 Required connections..... 3-4  
 Resetting the CPU..... 16-7  
   Resetting the CPU (initial setup) ..... 4-3  
 Rewind while playing ..... 9-5  
 RF gain ..... 4-4  
 RIT function ..... 7-3  
   Monitor function ..... 7-3  
 Roofing filter selection ..... 7-7  
 Receive Antenna-I/O selection..... 13-2  
 RTTY log  
   Confirm the RTTY log contents ..... 5-21  
   Turning ON the RTTY log ..... 5-20  
 RTTY memory  
   Editing the RTTY memory ..... 5-19  
 RTTY mode  
   Operating RTTY (FSK) ..... 5-14  
   RTTY DECODE SET ..... 2-5  
   RTTY decode set mode..... 5-22  
   RTTY LOG SET..... 2-5  
   RTTY memory transmission..... 5-17  
   RTTY reverse mode ..... 5-15  
   Setting the RTTY decoder threshold level ..... 5-17  
 RX-ANT ..... 13-2  
 RX-I/O..... 13-6  
   [RX-I/O] connector..... 20-5  
 RX Rec Condition ..... 9-13  
 RX Voice Memory ..... 9-7
- S**
- SAVE Contents..... 10-4  
 SAVE Form (Save format) ..... 10-4  
 Save set screen ..... 2-16, 10-4  
 Saving the setting data onto an SD card..... 10-5  
 Saving the setting data onto a USB flash drive .... 10-5  
 Saving with a different file name..... 10-7  
 Scanning..... 16-11  
 SCAN  
   Preparing for a scan ..... 12-3  
   SCAN Resume ..... 12-4  
   Scan Resume function ..... 12-3  
   Scan set mode ..... 2-6, 12-4  
   Scan speed ..... 12-3, 12-4  
   Scan types..... 12-2  
 Screen arrangement..... 15-3



User band edge .....	4-15
UTC Offset.....	14-2

## V

VBW .....	6-10
Vector tuning indicator .....	5-25
VFO or Memory mode selection.....	4-5
Voice 1st Menu .....	9-13
Voice RX Memory.....	9-7
Load setting.....	10-4
Basic recording.....	9-3
Playing back the recorded audio .....	9-8
Quick playing back.....	9-8
Recording a QSO .....	9-3
Recording contents .....	9-2
Recording the RX Voice Memory .....	9-8
Save setting.....	10-4
Voice Set mode .....	2-4, 9-13
Voice Squelch Control function.....	12-10
Voice synthesizer operation.....	16-2
VOICE TX Auto Monitor.....	9-13
Voice TX Memory	
Load setting.....	10-4
Recording or playing back a TX message .....	9-9
Save setting.....	10-4
Transmitting a recorded message .....	9-11
VOX .....	2-17
Adjusting the VOX function.....	8-2
VOX Delay .....	8-3
VOX set mode .....	8-3
VOX Voice Delay.....	8-3
Turning ON the VOX function.....	8-2

## W

Waterfall Display .....	6-11
Waterfall Marker Auto-hide .....	6-11
Waterfall Peak Color Level.....	6-11
Waterfall Size (Expand Scope).....	6-11
Waterfall Speed .....	6-11
Waveform Color (Current) .....	6-11
Waveform Color (Line).....	6-11
Waveform Color (Max Hold) .....	6-11
Waveform Type .....	6-11

## X

[X-VERTER] connector.....	20-4
---------------------------	------

---

## INSTALLATION NOTES

For amateur base station installations it is recommended that the forwards clearance in front of the antenna array is calculated relative to the EIRP (Effective Isotropic Radiated Power). The clearance height below the antenna array can be determined in most cases from the RF power at the antenna input terminals.

Different exposure limits have been recommended for different frequencies, a relative table shows a guideline for installation considerations.

Below 30 MHz, the recommended limits are specified in terms of V/m or A/m fields as they are likely to fall within the near-field region. Similarly, the antennas may be physically short in terms of electrical length and that the installation will require some antenna matching device which can create local, high intensity magnetic fields. Analysis of such installations is best considered in association with published guidance notes such as the FCC OET Bulletin 65 Edition 97-01 and its annexes relative to amateur transmitter installations. The EC recommended limits are almost identical to the FCC specified 'uncontrolled' limits and tables exist that show pre-calculated safe distances for different antenna types for different frequency bands. Further information can be found at <http://www.arrl.org/>.

### • Typical amateur radio installation

Exposure distance assumes that the predominant radiation pattern is forward and that radiation vertically downward is at unity gain (sidelobe suppression is equal to main lobe gain). This is true of almost every gain antenna today. Exposed persons are assumed to be beneath the antenna array and have a typical height of 1.8 m.

The figures assume the worst-case emission of constant carrier.

For the bands 10 MHz and higher the following power density limits have been recommended:

10–144 MHz      2 W/sq m

### EIRP clearance heights by frequency band

1 Watts	2.1 m
10 Watts	2.8 m
25 Watts	3.4 m
100 Watts	5 m
1000 Watts	12 m

### Forward clearance, EIRP by frequency band

100 Watts	2 m
1000 Watts	6.5 m
10,000 Watts	20 m
100,000 Watts	65 m

In all cases any possible risk depends on the transmitter being activated for long periods. (actual recommendation limits are specified as an average during 6 minutes) Normally the transmitter is not active for long periods of time. Some radio licenses will require that a timer circuit automatically cuts the transmitter after 1–2 minutes etc.

Similarly some types of emission, i.e., SSB, CW, AM etc. have a lower 'average' output power and the assessed risk is even lower.

Please record the serial number of your transceiver below for future servicing reference:

**Serial Number** : \_\_\_\_\_

**Date of purchase** : \_\_\_\_\_

**Place where purchased** : \_\_\_\_\_

**Count on us!**

**Icom Inc.**

1-1-32 Kamiminami, Hirano-ku, Osaka 547-0003, Japan